

PRESENTED BY



# 2019 WIRELESS & IoT EMC GUIDE



**ROHDE & SCHWARZ**

Make ideas real



Be ahead in 5G.

# TURN VISIONS INTO REALITY

The next major step beyond LTE/LTE-Advanced (4G) sets challenging requirements. Rohde&Schwarz is a world leader in all areas of RF and microwave test and measurement equipment. As a technology expert, we have been actively involved in mobile communications since the first generation. We are committed to supporting the wireless communications industry with the solutions needed to investigate, develop and standardize 5G.

Check out our test solutions at <https://bit.ly/31000mi>



# TABLE OF CONTENTS

Introduction 4

*Wireless & IoT EMC Supplier Matrix* 6

## FEATURED ARTICLES

Cost Effectively Ensure Electromagnetic  
Compatibility in the Age of IoT 9

MATTHEW MAXWELL

Rohde & Schwarz

Ten Tips to Minimize EMI from  
On-Board DC-DC Converters 16

KENNETH WYATT

Wyatt Technical Services LLC

FCC Label Changes 20

GHERY S. PETTIT

Pettit EMC Consulting LLC

PC Board Design for Wireless Products 23

KENNETH WYATT

Wyatt Technical Services LLC

## ADVERTORIAL

Integrated Passive Components (IPCs) Simplify  
Signal Conditioning in Package that is 20% the Size 32

MANUEL CARMONA

Johanson Technology

## REFERENCES

Wireless Groups & Organizations 34

Wireless Conferences 2019 – 2020 35

Wireless Technologies 37

Useful Wireless References 38  
GROUPS, WEBSITES, BOOKS, FORMULAS,  
TABLES, LINKS & WHITEPAPERS

Index of Advertisers 41

# INTRODUCTION

As we've become a mobile society, wireless and IoT EMC have burst onto the scene as common issues. The proliferation of current and developing systems for wireless, broadcast, two-way communications, and "Internet of Things" (IoT) only make the risk of interference greater. The fact that most of the wireless systems are relegated to rather narrow ISM (Industrial, Scientific, and Medical) frequency bands makes for an increasingly crowded spectrum.

This new **2019 Wireless & IoT EMC Guide** will include content and reference material in three primary areas:

- Interference to wireless systems, resulting in spectrum congestion and resulting data slowdown.
- Interference Hunting — finding and mitigating sources of interference to wireless, broadcast, and communications systems.
- Platform Interference — that is, self-interference to on-board telephone and wireless modules from noise sources, such as DC-DC converters and other high frequency sources that degrade cellular telephone receiver sensitivity.

In addition, we include a reference section with a host of useful information on wireless networks, protocols, frequencies, bands, organizations, and pertinent conferences and trade shows.

We're hoping this will be of value to those who are installing or managing wireless networks, as well as those in the communications and broadcast industry that are designing and installing systems. Tools and techniques are described for identifying, locating, and mitigating sources of interference, including those within the product itself.



# THE SKY'S THE LIMIT

Anritsu introduces the Field Master Pro™ MS2090A.  
The world's highest performance handheld  
spectrum analyzer.



FieldMaster Pro™

## No gaps. No limits. No misses.

The Anritsu Field Master Pro MS2090A spectrum analyzer delivers field measurements never thought possible. It's packed with the latest innovations including maximum real-time bandwidth of 100 MHz, integrated coverage up to 54 GHz and 4G/5G demodulation all in a single portable package. Best of all, it's from Anritsu. Your trusted partner in testing.

Download our application note, [Coverage Mapping with Anritsu's Field Master Pro MS2090A and NEON® MA8100 Signal Mapper Solution](#) to learn more today.

**Anritsu**  
www.anritsu.com

© 2019 Anritsu Company



Integrated frequency  
coverage from 9 kHz  
to 54 GHz - no gaps!



Real-time analysis  
bandwidth of 100 MHz



Ability to demodulate  
and identify 5G signals



Highest level of insight  
into network performance

# WIRELESS & IoT EMC SUPPLIER MATRIX

## Introduction

There are two main categories of equipment in this handy supplier guide: EMI troubleshooting & measurement equipment and direction finding equipment.

EMI troubleshooting and measurement equipment includes spectrum analyzers, near field probes, current probes, antennas, and other pre-compliance equipment.

Direction finding (or DFing) equipment usually includes specialized portable, mobile, or base station spectrum analyzers with custom antennas and mapping software especially designed for locating interfering sources.

Wireless & IoT EMC Supplier Matrix		Type of Equipment								
MANUFACTURER	CONTACT INFORMATION - URL	AMPLIFIERS	ANTENNAS	CURRENT PROBES	FIXED DF SYSTEMS	MOBILE DF SYSTEMS	NEAR FIELD PROBES	PORTABLE DF SYSTEMS	PRE-COMPLIANCE TEST	SPECTRUM ANALYZERS / RECEIVERS
360Compliance	<a href="http://www.360compliance.co/">www.360compliance.co/</a>								X	
Aaronia AG	<a href="http://www.aaronia.com">www.aaronia.com</a>	X	X		X	X		X	X	X
Alaris Antennas	<a href="http://www.alarisantennas.com">www.alarisantennas.com</a>		X							
Anritsu Company	<a href="http://www.anritsu.com">www.anritsu.com</a>		X							X
Avalon Test Equipment Corp	<a href="http://www.avalontest.com">www.avalontest.com</a>	X	X	X		X	X		X	X
CommsAudit	<a href="http://www.commsaudit.com/products/direction-finding">www.commsaudit.com/products/direction-finding</a>		X		X	X				X
Doppler Systems	<a href="http://www.dopsys.com">www.dopsys.com</a>		X		X	X		X		
The EMC Shop	<a href="http://www.theemcshop.com">www.theemcshop.com</a>	X	X	X			X		X	X
Gauss Instruments	<a href="http://www.gauss-instruments.com/en/">www.gauss-instruments.com/en/</a>									X
Intertek	<a href="http://www.intertek.com">www.intertek.com</a>								X	
Kent Electronics	<a href="http://www.wa5vjb.com">www.wa5vjb.com</a>		X							

Wireless & IoT EMC Supplier Matrix		Type of Equipment								
MANUFACTURER	CONTACT INFORMATION - URL	AMPLIFIERS	ANTENNAS	CURRENT PROBES	FIXED DF SYSTEMS	MOBILE DF SYSTEMS	NEAR FIELD PROBES	PORTABLE DF SYSTEMS	PRE-COMPLIANCE TEST	SPECTRUM ANALYZERS / RECEIVERS
Keysight Technologies	<a href="http://www.keysight.com/main/home.jsp?cc=US&amp;lc=eng">www.keysight.com/main/home.jsp?cc=US&amp;lc=eng</a>						X		X	X
Morcom International	<a href="http://www.morcom.com/direction_finding_systems.html">www.morcom.com/direction_finding_systems.html</a>							X		X
MPB srl	<a href="http://www.gruppompb.uk.com">www.gruppompb.uk.com</a>		X	X					X	X
MVG, Inc	<a href="http://www.mvg-world.com/en">www.mvg-world.com/en</a>		X				X		X	
Narda/PMM	<a href="http://www.narda-sts.it/narda/default_en.asp">www.narda-sts.it/narda/default_en.asp</a>	X	X						X	X
Pearson Electronics	<a href="http://www.pearsonelectronics.com">www.pearsonelectronics.com</a>			X						
RDF Antennas	<a href="http://www.rdfantennas.com/bc-121-5.php">www.rdfantennas.com/bc-121-5.php</a>							X		
RDF Products	<a href="http://www.rdfproducts.com">www.rdfproducts.com</a>				X	X				X
Rhotheta America	<a href="http://www.rhothetaamerica.com/index.html">www.rhothetaamerica.com/index.html</a>				X	X		X		
Rigol Technologies	<a href="http://www.rigolna.com">www.rigolna.com</a>			X			X		X	X
R&K Company Limited	<a href="http://www.rk-microwave.com">www.rk-microwave.com</a>	X								
Rohde & Schwarz USA, Inc.	<a href="http://www.rohde-schwarz.com/us/">www.rohde-schwarz.com/us/</a>	X	X	X	X	X	X	X	X	X
Siglent Technologies	<a href="http://www.signlentamerica.com">www.signlentamerica.com</a>						X			X
Signal Hound	<a href="http://www.signalhound.com">www.signalhound.com</a>			X						X
SPX/TCI	<a href="http://www.spx.com/en/our-businesses/detection-and-measurement/TCI/">www.spx.com/en/our-businesses/detection-and-measurement/TCI/</a>		X		X	X		X		X
SteppIR Communication Systems	<a href="http://www.steppir.com">www.steppir.com</a>		X							
TechComm	<a href="http://www.techcommdf.com">www.techcommdf.com</a>		X		X	X		X		X
Tektronix	<a href="http://www.tek.com">www.tek.com</a>					X	X	X	X	X
Teseq	<a href="http://www.teseq.com/en/index.php">www.teseq.com/en/index.php</a>	X		X					X	
Thurlby Thandar (AIM-TTi)	<a href="http://www.aimtti.us">www.aimtti.us</a>								X	X
TMD Technologies	<a href="http://www.tmd.co.uk">www.tmd.co.uk</a>	X								
UST	<a href="http://www.unmannedsystemstechnology.com/company/marshall-radio-telemetry/">www.unmannedsystemstechnology.com/company/marshall-radio-telemetry/</a>							X		X

# 200V/m THE WAY IT WAS MEANT TO BE

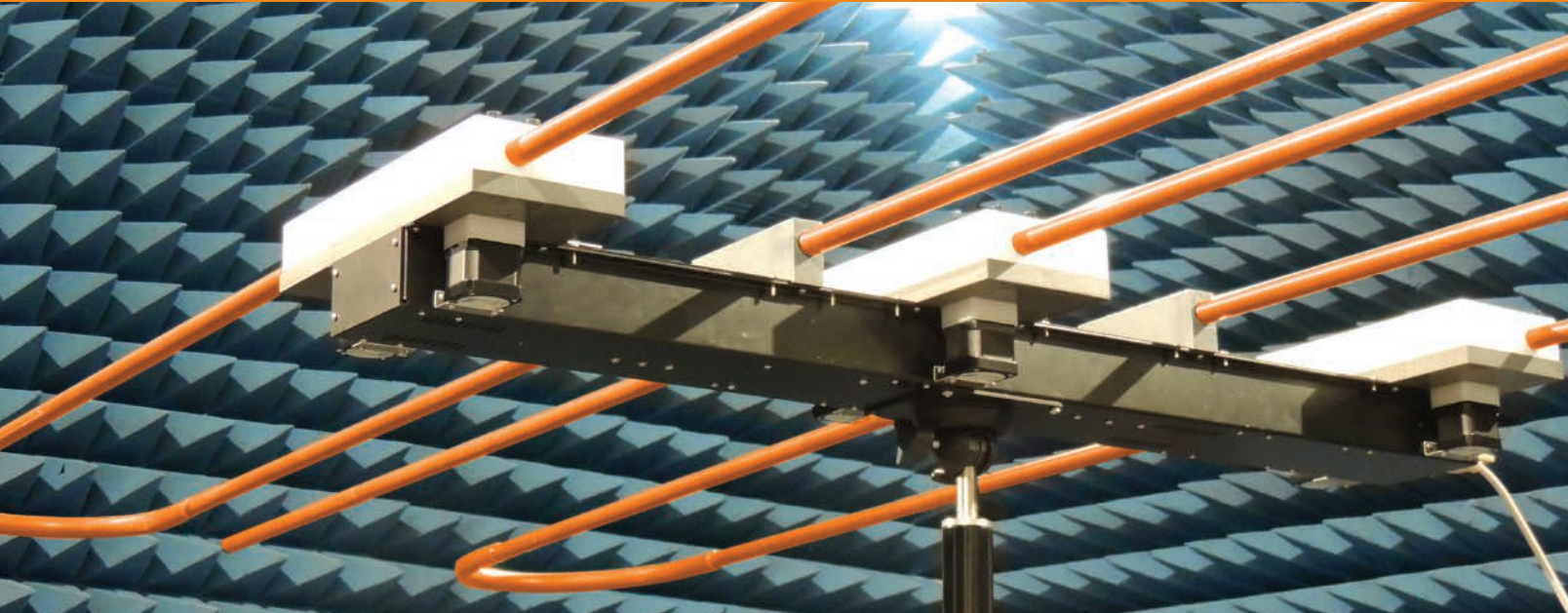

The SteppIR SY3-EMC Auto-tuned Yagi system is the solution to MIL-STD-461G and RS-103 for radiated susceptibility testing within the 30-200 MHz frequency range – making it the only system in the world that can legitimately claim to reach or exceed the required 200 V/m @1 Meter, at the fundamental frequency.



- 200 V/m achieved with average input power of 975 watts\*
- 1.5:1 average SWR throughout the frequency range
- Hi-Q antenna design greatly reduces harmonics, with typical reduction of 25 dB – ensures the field probe is measuring the field from the fundamental frequency – not from the harmonics
- Fully auto-tuned system using patent pending software algorithm creates optimized, resonant antennas at every single test frequency

\* Power requirements will vary depending on the test chamber configuration. Chamber for this test was fully anechoic.

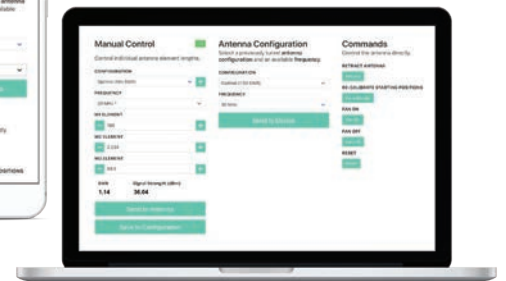
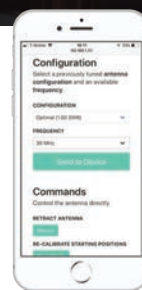

The user interface is available for PC / Mac and iPhone /android devices. We also have a developer site available for interfacing the OptimizIR-EMC system with popular industry software.



# COST EFFECTIVELY ENSURE ELECTROMAGNETIC COMPATIBILITY IN THE AGE OF IoT

---

**Matthew Maxwell**  
Rohde & Schwarz

*Wireless/RF is ubiquitous, so implement a pre-compliance regimen with off-the-shelf equipment.*



### COST EFFECTIVELY ENSURE ELECTROMAGNETIC COMPATIBILITY IN THE AGE OF IoT

Every electronic product has to go through full electromagnetic compatibility (EMC) testing to get the much-coveted stamp of approval from the various regulatory bodies. This has traditionally been a costly undertaking with multiple trips to a distant testing facility, with multiple reworks required to get final approval. In the age of the Internet of things (IoT), this is not the way to go about it. There is a better approach.

The IoT has changed everything, with wirelessly connected devices creating the opportunity to gather data to perform analytics in order to improve device usability for consumers. For industry, IoT-enabled analytics are improving process, safety, and production outcomes for manufacturing facilities, while opening the possibility of new business models. However, for electronic system and consumer product designers, it has created a number of headaches; some obvious, some more subtle and insidious.

To start with, there's the ubiquitous demand for wireless connectivity, whether it be Wi-Fi, Bluetooth, Zigbee,

cellular, or the various flavors of long-range, low-power options such as LoRaWAN, Sigfox, Narrowband-IoT (NB-IoT) or LTE Cat 1. It's common to have multiple RF interfaces in the same device. This is great for users, but is a nightmare for designers, many of whom are not RF experts. They may have mastered the art of ensuring power supplies no longer interfere with digital circuits, but wireless connectivity adds a whole new dimension of difficulty. From the antenna placement and routing, to the design of high-frequency circuits from 900 MHz to 5 GHz, the difficulties have affected many product delivery schedules, and the problem is only going to get worse with 5G emerging with millimeter-wave operation at 28 GHz and up.

Brave designers will "roll their own" RF circuits, but these tend to be large design teams with high-volume expectations. It seems easy enough, get a good RF integrated circuit (IC) from a reputable vendor, put some shielding around it, place and route the antenna wire, and they're off and running. Maybe. However, a few trends have altered the design landscape and have forced designers to rethink their approach.

The primary influences on designs are smaller form factors, higher integration, and electronic component densi-

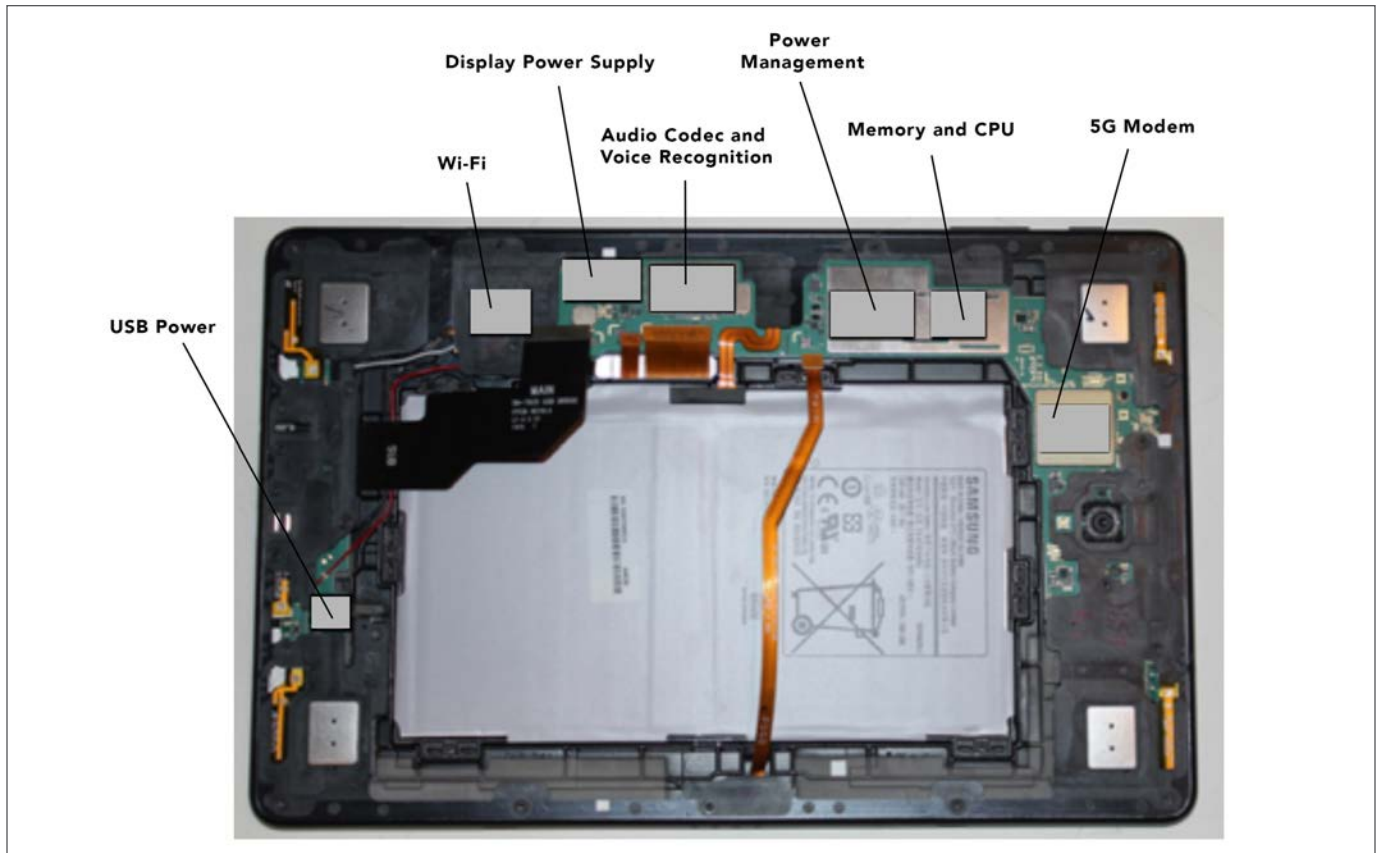

Figure 1: It used to be sufficient to shield a couple of key circuits, but the designers of the Samsung Tab S4 tablet shielded literally every circuit to ensure maximum EMC. The four rectangular silver elements on the corners are speakers, not circuits. (Image source: Rohde & Schwarz)

ty per inch squared of printed circuit board (PCB) space, system complexity, higher clock speeds, multiple and distributed power rails with fast-switching transients, LCD emissions as displays get integrated into IoT devices, and faster data transfer rates between central processing unit (CPU) and memory. These are the obvious and classic trends that create interesting challenges that designers actually enjoy solving, though time-to-market pressures and shrinking budgets can be a kill-joy for some, or an added challenge for others.

However, as mentioned, there are two more subtle trends, and these are the ones that are actually causing the most headaches, and the most opportunity for differentiation through innovative approaches to expediting the route to ensuring system EMC.

These trends, which are a direct result of the IoT, are the need to combine power supplies, high-performance digital circuits, and RF interfaces in compact form factors for products that are falling rapidly in price. So much so, that the complexity-to-price ratio is becoming untenable for high-quality, low-cost, smart-home-based systems that are the sweet-spot for IoT devices. Even mobile phone and tablet manufacturers, which have typically been able to charge a premium for higher margins, are getting squeezed as complexity increases and form factors shrink.

To address EMC and its associated electromagnetic interference (EMI) issues, it used to be sufficient to place shielding around key components, such as the RF cir-

cuits, to reduce their susceptibility to interference from high-speed digital clock and signal switching harmonics, and to prevent them from being an interferer. However, as density and complexity has increased, it's now not uncommon to shield literally everything, as in the case of the Samsung Tab S4, *Figure 1* (see page 10).

The Tab S4 is an extreme example of cutting-edge consumer-level design in terms of density, performance, and complexity, with a price to match (\$649). However, most designs in the IoT space, from white goods and audio streaming systems with built-in voice assistants, to wearables, cost much less, forcing designers to find ways to lower development and test costs.

**ACCELERATING EMC TESTING — WHILE LOWERING COST**

It's possible to accelerate the design and test cycle when using power-supply and RF modules. These come pre-certified and do save time and resources. However, many designers falsely assume that buying a module means they're home free with respect to national and international compatibility and compliance regulations. Nothing could be further from the truth.

It's true that the RF module may remain fully Bluetooth certified and interoperable, but once the power supply, RF module, antenna, and digital circuits are laid out and connected all regulatory certification bets are off. The *full system* now needs to be certified to CE, FCC, or CISPR requirements, due to the many and varied interactions

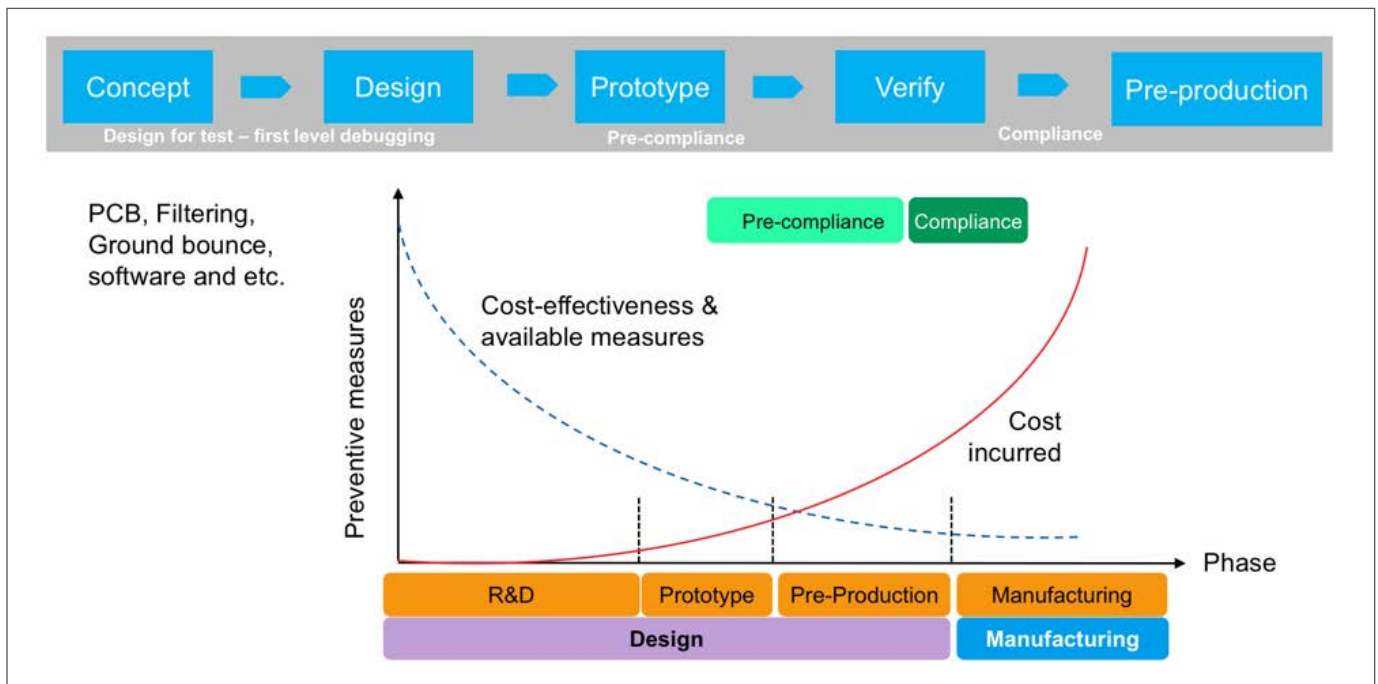

Figure 2: Implementing a regimen of pre-compliance checkpoint tests can greatly increase the chance of completing an IoT design on time and within budget. (Image source: Rohde & Schwarz)

between the subsystems. These include load transients, spurious power-supply emissions, various internal and ambient EMI sources, and RF harmonics.

The task for designers is to understand EMC and the effects and sources of EMI, and then performance pre-compliance testing on the system to identify and mitigate any issues — before sending it out to an external lab for certification. Along with the expense of time, the compliance tests themselves can cost up to \$10,000 and up to 90 percent of devices fail the first time around, leading to rework and retesting, sometimes multiple times. The costs add up quickly, especially if the fix requires a full or partial redesign. It's critical to initiate preventative measures, such as design-cycle checkpoints, to help avoid costly project delays, *Figure 2* (see page 11).

Another important reason to perform pre-compliance testing is to avoid over-design of the device. Often, designers run the risk of adding additional shielding or other precautions, which adds weight, time, power consumption, and direct costs. The goal is to pass the test for full compliance without going overboard.

In order to minimize the chance of multiple rounds of compliance certification and rework, it helps to have some up-front education on EMC and EMI. Combined with off-the-shelf test equipment and some “tricks of the trade,” it's possible to quickly identify and mitigate EMC issues before submitting a system for formal certification.

### DEFINING EMC AND IDENTIFYING SOURCES OF EMI

EMC and EMI are often confused, but simply put, EMC is concerned with ensuring various pieces of electrical and electronic equipment can operate in the same electromagnetic environment. It requires the equipment to have minimal unwanted electromagnetic emissions and to also minimize its susceptibility to ambient electromagnetic energy, typically from nearby equipment or long-range radio transmitters.

EMI is the actual unwanted electromagnetic energy that designers need to suppress within their own designs, as well as protect their design from outside sources. These sources can be static electricity, other radios, sporadic emissions from motors or power supplies, mains hum, microwave ovens and the system's internal digital switching harmonics and sub-harmonics, and even audio signals. Their interference potential depends upon the operating frequency of the equipment under test (EUT) and they can manifest as continuous wave or pulsed EMI signals.

In EMC parlance, the system causing the interference is the source, and the system being affected is the victim. Between them are the four EMI coupling mechanisms: radiated, inductive, capacitive, and conductive, or any combination of the four, *Figure 3*. EMI can be viewed fractally in the sense that it applies between small or large systems

that are near or far apart, as well as between subsystems, components, traces, and antenna within a system. Not that antennas are particularly interesting, as they not only transmit and receive intentional emissions, but also serve as perfect couplers of EMI into and out of a system.

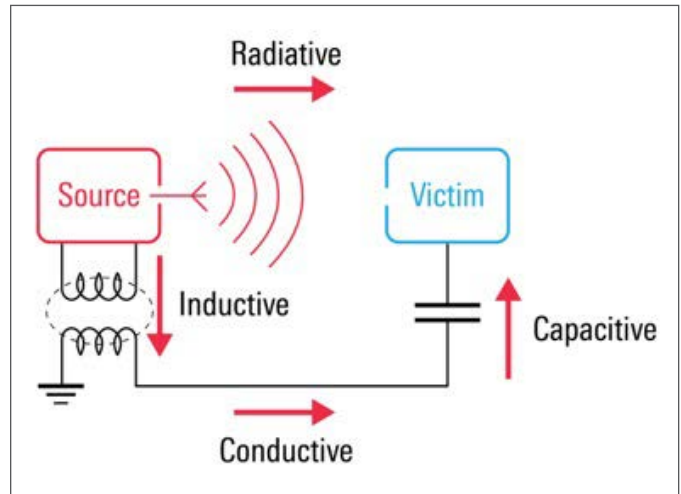

Figure 3: The four EMI coupling mechanisms are radiative, inductive, capacitive and conductive. (Image source: ipfs.io)

The EMI and EMC principles are similar for nearby and within systems. For the sake of simplicity, this article will focus on a single system and how to design for EMC, perform pre-compliance testing, and debug using an off-the-shelf, mid-range oscilloscope.

### DESIGNING FOR EMC

Let's consider the following basic principles to demonstrate that EMC hasn't changed since EE 101:

- Be careful on trace routing
- Be aware that higher speeds mean more EMI issues
- PCB stacking makes EMI worse
- Avoid sharp corners in traces (reasonable design tools can match the maximum trace angle to the operating frequency)
- Have larger ground planes
- Use shielded cables and housings
- Avoid discontinuities and resonances in the transmission path

Unfortunately, EMI cannot be eliminated entirely. Thus the designer's job is to manage and mitigate it, applying fundamental principles in combination with experiential know-how.

### PRE-COMPLIANCE TEST AND DEBUG

Once the design is in the prototype stage and pre-compliance checkpoints have been established, the next task is to either isolate the EUT completely from ambient EMI, or

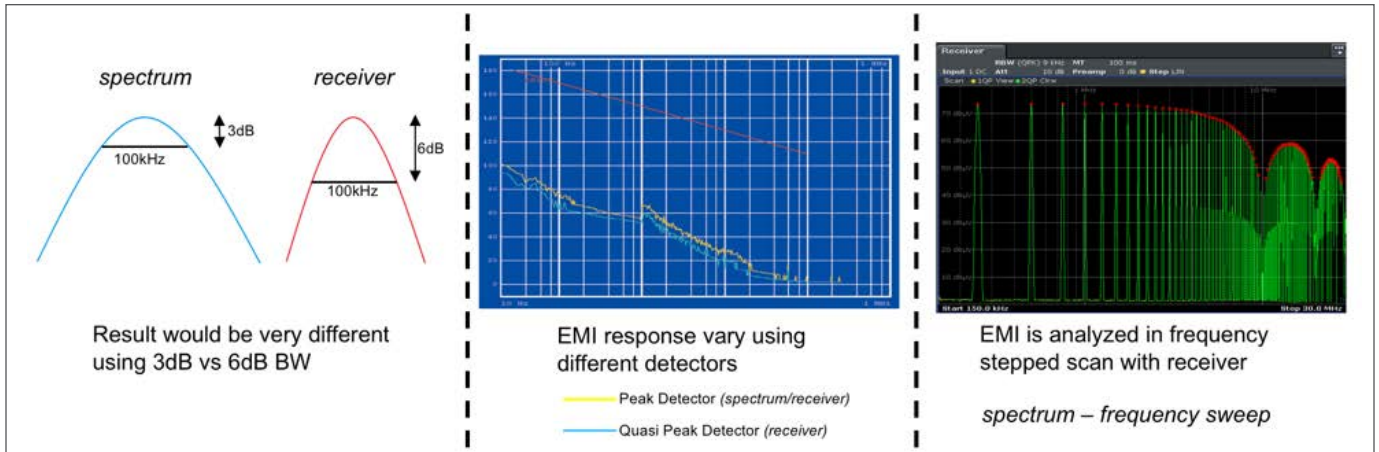

Figure 4: When in receive mode, spectrum analyzers can imitate higher cost EMI receivers, but make sure it has at least a quasi-peak (QP) detector with a directional antenna. (Image source: Rohde & Schwarz)

to characterize the environment and account for detected interferers during the test cycle. Again, interferers also cannot be eliminated, but the probability of interference can be determined and mitigated.

To scan a wide range of frequencies for interferers, a full EMI receiver with an array of filters and wide dynamic range is a good option, but can be expensive. Alternatively, a spectrum analyzer can come close to an EMI receiver’s capabilities without breaking the bank. Start by getting a baseline and account for any present signals. Spectrum analyzers, such as the R&S®FPC1500, have optional PC EMI software (Elektra) that can set the compliance limits, or the user can do it manually, *Figure 4*.

The spectrum analyzer itself will need at least a quasi-peak (QP) detector with a directional antenna as part of the minimum viable feature sets to approximate a full EMI-compliant receiver. Look for an analyzer with a frequency range from 5 kHz to 5 GHz to detect sub-GHz signals and 5-GHz Wi-Fi network interferers. Also, a built-in vector network analyzer (VNA) is useful as it can be used to match the antenna impedance to the RF module if there isn’t an RF antenna built in. Some spectrum analyzers also have an integrated signal generator that can be used to generate an additional signal in the presence of the intended transmitter signal. This “interferer” tests to make sure there is sufficient blocking at the receiver to allow the intended signal to get through.

To start pre-compliance testing, do a limit-line test, or max hold sweep, with a max hold detector, as that’s a fast and easy test. Then, use the QP detector to do spot checks on any potential problem areas. Use electric field (E-field) and magnetic field (H-field) near-field probes, *Figure 5*. The magnetic field probe has a loop through which the magnetic field passes perpendicularly, inducing a detectable voltage.

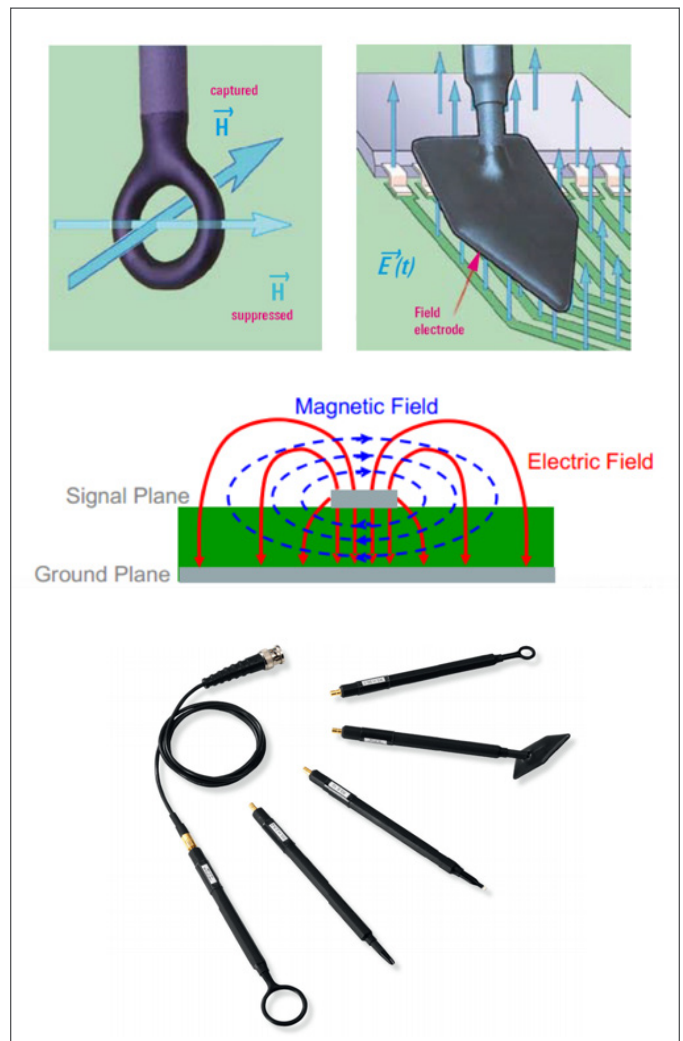

Figure 5: The larger the size of the E-field and H-field probes, the greater their sensitivity, at the cost of precision. It helps to zero in on the EMI source by reducing the size of the probe. (Image source: Rohde & Schwarz)

When using the probes, it’s important to keep in mind that

the output of the probe very much depends upon the orientation of the probe relative to the emitters. Also, there is a trade-off to be made: the larger the probe, the greater the sensitivity, but the precision decreases. So, as the source of EMI gets more clearly defined, reduce the size of the probe to zero in on the source and verify that the readings are below the maximum power levels allowed.

This requires having a solid knowledge of the design to know where these might be. Many EMI sources can be anticipated by factoring in the clock frequencies, the power supply's switching frequency, and the expected harmonics.

Knowing the layout is critical, as it helps to know when a clock line might be too close to an RF module. This becomes something to watch for as it might be what's coupling in and causing another spur that's in a different part of the spectrum.

However, no matter how good a designer's knowledge of the physical layout and the circuit's design parameters, nothing beats running the system software and time-correlating the EMI to the running code.

**TIME-CORRELATED TEST AND DEBUG WITH OSCILLOSCOPES**

Given the budget and resource constraints of many IoT developers, a spectrum analyzer may be out of reach. However, every bench has an oscilloscope, and the right

digital oscilloscope can also perform EMI test. This was not always the case, as the fast Fourier transform (FFT) processing capability wasn't available. That has changed, with some digital oscilloscopes now implementing FFT digital down-conversion and overlapping FFTs in hardware.

Look for a digital oscilloscope with these key characteristics: enough capture memory (can hold greater than 500 Ksamples), 50-Ω coupling impedance to ensure sufficient bandwidth and a sample rate >2x the maximum frequency, start with 2.5 Gsamples/s for 0 to 1 GHz. If testing systems with 2.45-GHz or 5-GHz radios, the sample rate will need to be upgraded accordingly. Also look for low noise and good vertical sensitivity capable of being set to 500 μV/div to 5 mV/div for high sensitivity over the full bandwidth.

As the probe will be moving around the board or system, it's important that the scope's response time be fast so there's no delay when trying to correlate EMI back to the time domain. Some scopes do include FFTs in software, so be careful to ensure the time and frequency domain are seen in real time. As the source of the EMI becomes clearer, the time-domain view should allow the EMI source to be correlated to changes such as bus level switching, *Figure 6*.

Other features to look for on a scope include a color table and screen persistence to easily detect and distinguish continuous wave signals, burst signals, and signal zoom: *Figure 7* (see page 15).

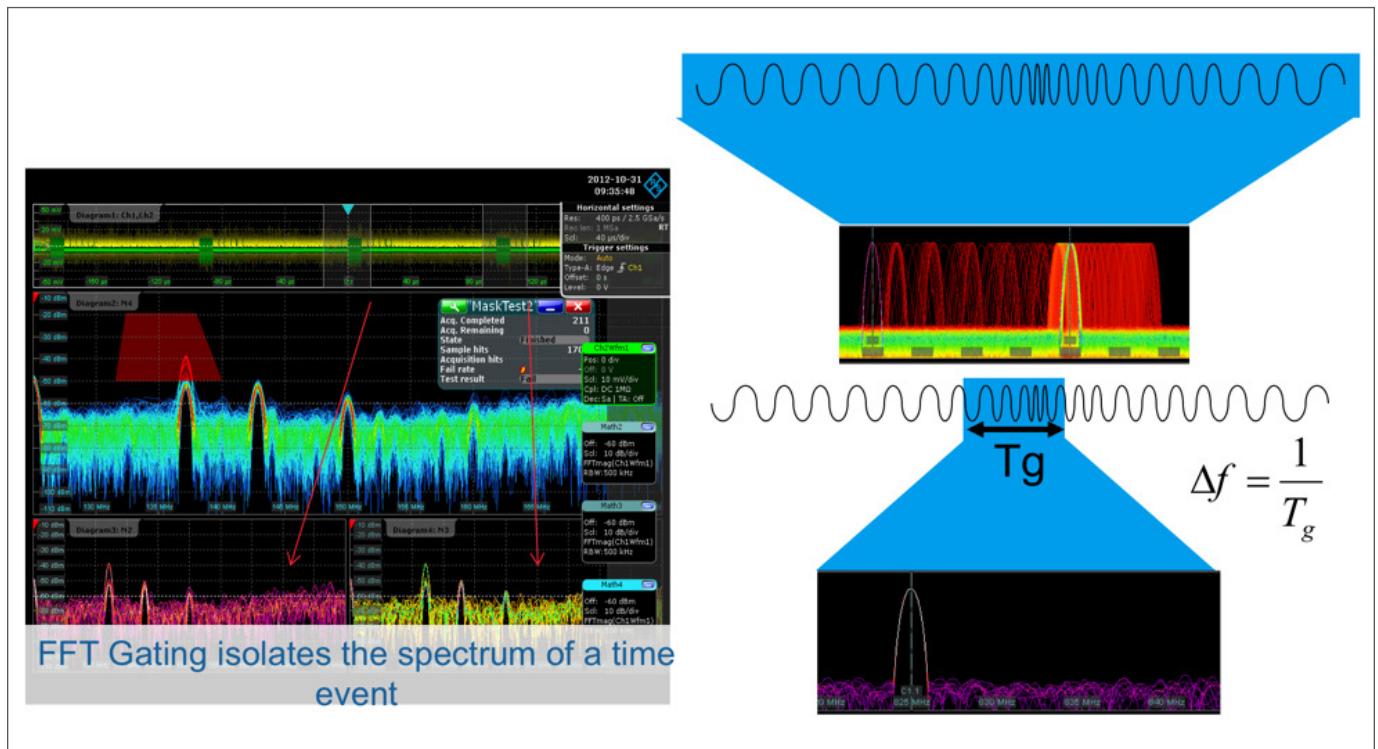

Figure 6: Multi-domain digital oscilloscopes with fast FFT capability and a gating feature help debug by allowing users to time-correlate EMI events and find their origin. (Image source: Rohde & Schwarz)

**CONCLUSION**

In the age of IoT, with ubiquitous wireless connectivity, meeting EMC requirements for any standard is becoming more difficult and time consuming. The problem is exacerbated by the falling cost of IoT devices, which puts pressure on designers to get it right the first time

to avoid extra certification costs and rework. That said, implementing a strict pre-compliance test regimen and checkpoints combined with typical benchtop equipment, such as digital oscilloscopes, can help limit formal and expensive EMC certification testing to one round.

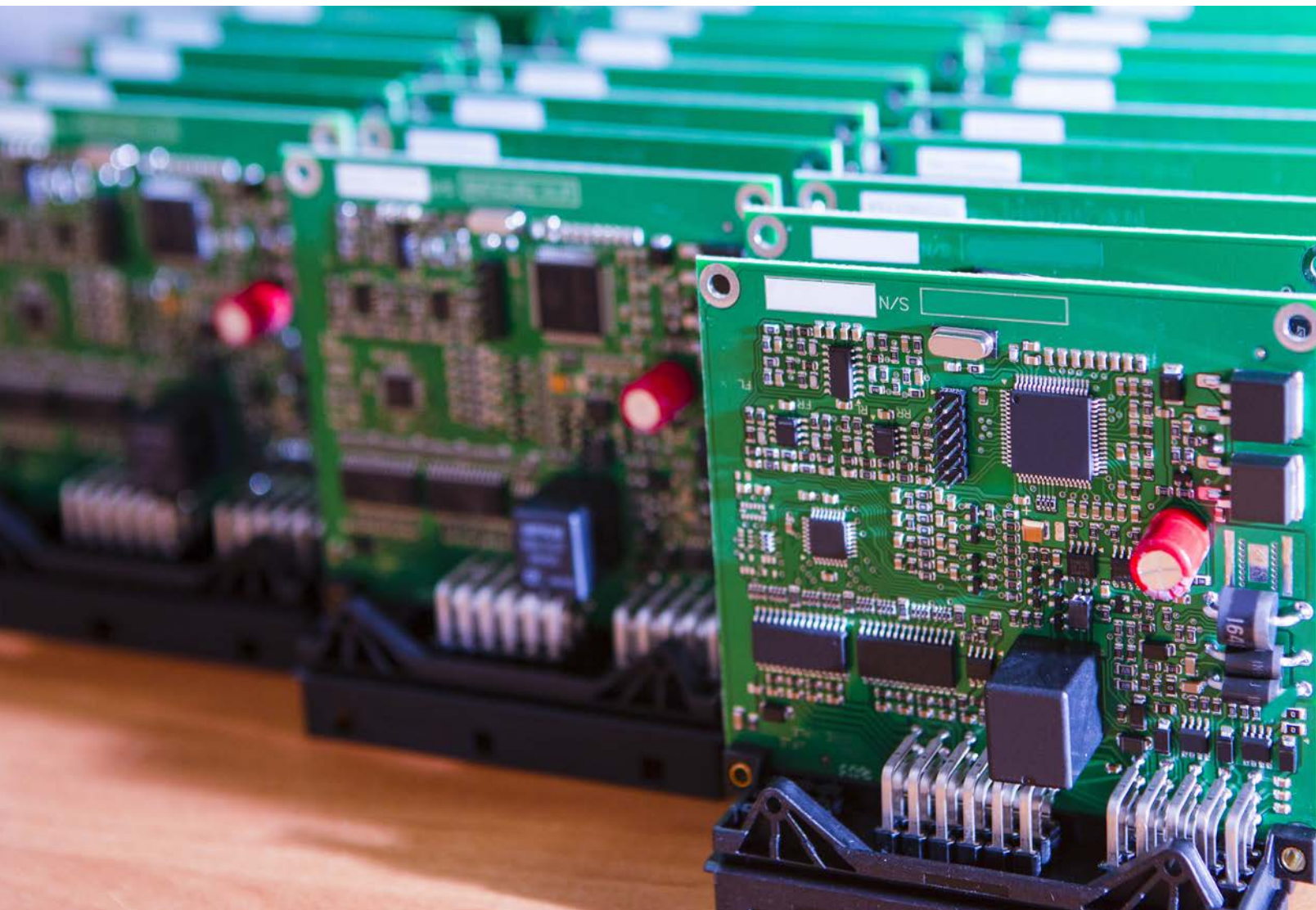

Figure 7: The R&S®RTO2000's 10.1-inch capacitive touchscreen allows users to quickly navigate pop-up menus and adjust scaling by zooming in or moving a waveform. (Image source: Rohde & Schwarz)

# TEN TIPS TO MINIMIZE EMI FROM ON-BOARD DC-DC CONVERTERS

---

**Kenneth Wyatt**  
Wyatt Technical Services, LLC  
[ken@emc-seminars.com](mailto:ken@emc-seminars.com)





## TEN TIPS TO MINIMIZE EMI FROM ON-BOARD DC-DC CONVERTERS

It is fairly common to find multiple on-board DC-DC converters on today’s portable, mobile, and IoT devices. If the device uses wireless, GPS, or cellular technologies, the EMI from these converters (which generally use switching frequencies between 1 and 3 MHz) often interferes with the receiver performance of the wireless modules.

The problem really crops up for low-band cellular (700-900 MHz) or GPS (1575.42), and perhaps less so for Wi-Fi (2.4 GHz), as the harmonic emissions from these converters often extend up to 2 GHz, or more. Cellular providers have strict receiver sensitivity requirements and the Total Isotropic Sensitivity (TIS) is one of the tests performed during CTIA compliance. If the receiver is not sensitive enough, the product will not be allowed onto the cellular system (*References 1 and 2*).

This article describes the top 10 methods for reducing the emissions from these DC-DC converters. They are listed in no particular order — all are important.

**1. Specify low-EMI converters.** Both Texas Instruments (TI) and Analog Devices / Linear Technologies (AD) continue to develop low-EMI devices. AD recently developed their Silent Switcher, which accommodates locating the input and output capacitors particularly close to the IC package. Their newer Si-

lent Switcher 2 low-EMI converters incorporate both the input and output capacitors and their associated loops, within the IC package. Finally, their “µModule” series of converters also incorporate the output inductor, as well. While more expensive, these are all particularly quiet for EMI.

- 2. Use a proper PC board stack-up.** Most of my clients get this wrong (*Figure 1*). All signal layers must have an adjacent ground reference plane (GRP) and all power traces (or planes) must also have an adjacent GRP (*Figure 2*, see page 18). This is because all microstrip, stripline, and power routing should be considered transmission lines in today’s fast digital technology. If this rule is not followed, expect noise and signal coupling between circuits (one form of crosstalk), radiated EMI, and board edge radiation directly into the antenna.
- 3. The ground reference plane (or planes) must be solid.** Fast switching signals or converter traces crossing gaps or slots within the ground reference plane (GRP) will couple EMI throughout the board and can couple into sensitive receivers. Note that some of TI’s older data sheets (*Note 1*, see page 19) recommend carving away the GRP (and all other signals) from around the path of the circuit trace from the converter SW node to the input of the output inductor. This is incorrect! This trace MUST be adjacent to a solid GRP. Otherwise, their layout suggestions are OK. Please refer to the video demo explaining why gaps in the GRP are a disaster for EMI (*Reference 3*).

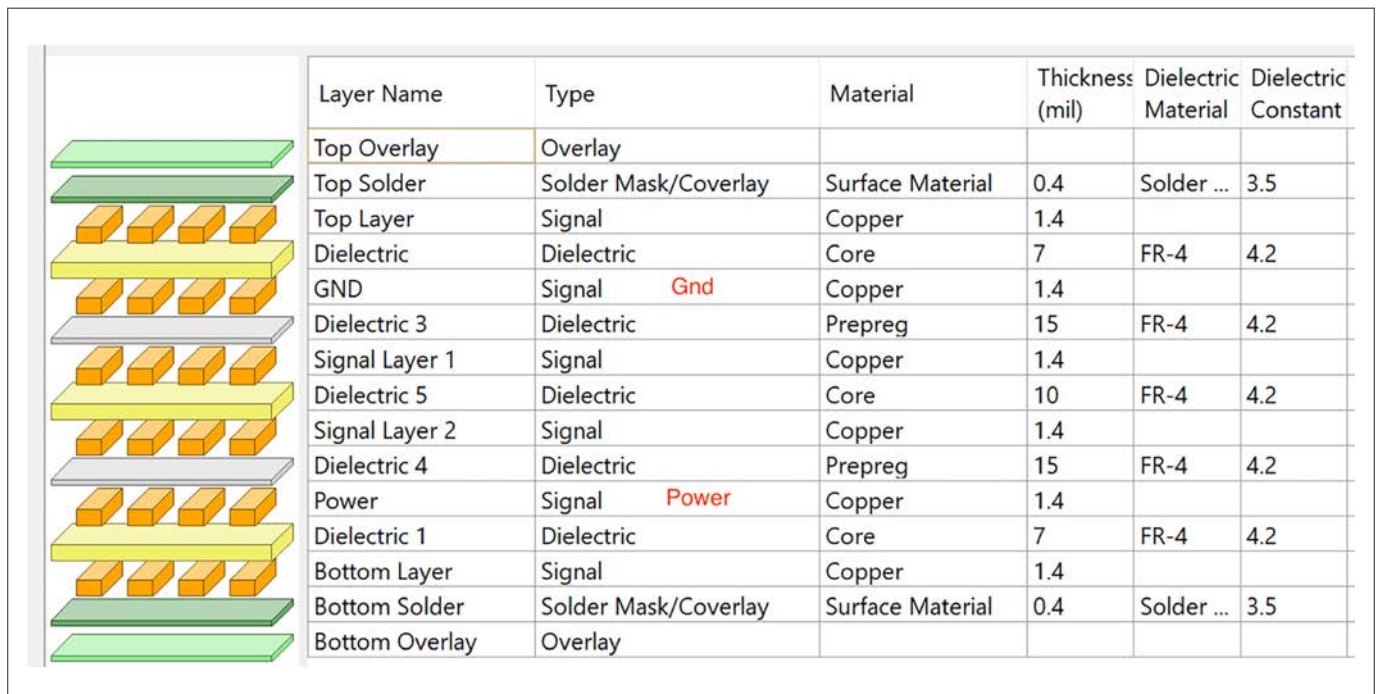

Figure 1 - A very common, but poor, EMI stack-up design (6-layer example). Signal layers 4 and 6 are referenced to power, while the GRP and power planes are non-adjacent with two signal layers in between. This will couple power transients on those two signal layers.

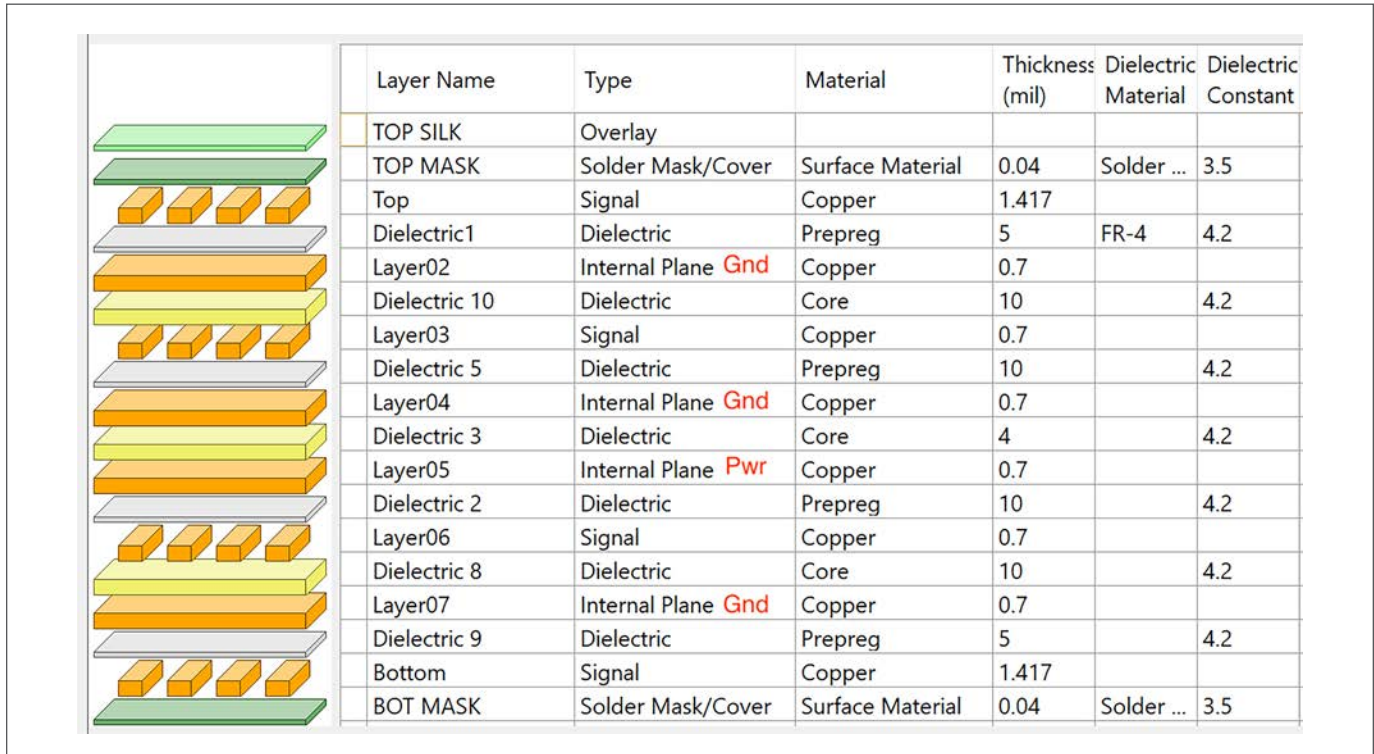

Figure 2 - A good EMI stack-up design (8-layer example). All signal layers are referenced to an adjacent GRP, while power is also referenced to an adjacent GRP.

**4. Keep all DC-DC converter circuitry on the top layer and over an adjacent GRP.** One issue that creates noise coupling is running fast switching signals from the top to bottom of the PC board. I had one client locate the converter circuitry on top and the output inductor at the bottom of their board. The resulting 3 MHz switching currents flowing from top to bottom and back created enough interference to block on-board GPS reception. If fast rise-time signals must be routed from top to bottom, this generally requires an adjacent stitching capacitor (connected power to GRP) located next to the via to provide a nearby return path for the signal current back to the source.

**5. Keep all DC-DC converter circuitry extremely close to the converter IC.** DC-DC converters always have an input current loop and an output current loop (Figure 3). These loop areas must be minimized. IC manufacturers are starting to recognize EMI is an issue and warn designers about this. The converter manufacturers often (towards the end of the data sheet.) offer a suggested layout. Layout suggestions in the last 2-3 years are usually accurate. If they are older than that, they are often incorrect. Both the input and output capacitors, along with the output inductor, should be located as close to the IC package as possible to minimize these loops.

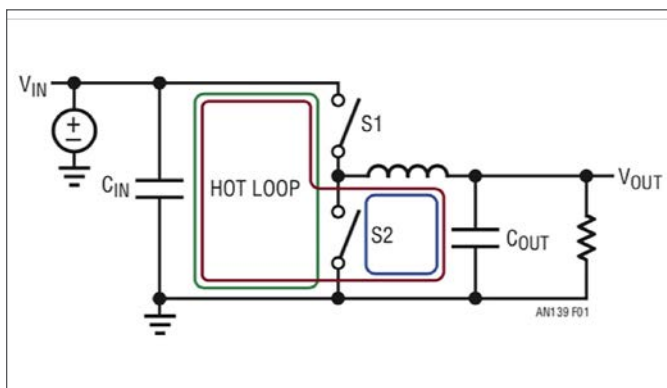

Figure 3 - An illustration showing the two “hot” current loops in typical DC-DC buck converters; one on the primary input and one on the secondary output. (Image source: Analog Devices / Linear Technology AN-130)

**6. Locate DC-DC converter circuitry close to the power entry of the board.** This will tend to localize the switching currents away from sensitive wireless modules (Reference 4). However, there may be cases where the wireless module manufacturer wants a converter located near the module. If this is the case, observe all the other rules and face an increased risk in EMI coupling directly to the antenna.

**7. The output inductor should be a shielded design.** There are two types of inductor; shielded and unshielded. Always use a shielded inductor, because this tends to confine the magnetic H-field better. If you can see the windings, it’s an unshielded design (Figure 4, see page 19).

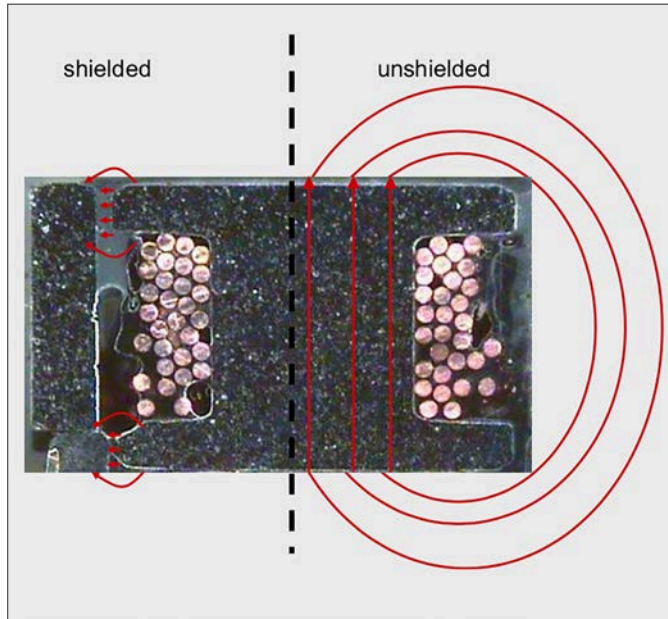

Figure 4 - A cross section of two typical ferrite core inductors. You can see the turns in the unshielded style (right side), but not in the shielded style (left side). The extra ferrite shield confines the magnetic field much better (red arrows). (Image source: Würth Elektronik eiSos)

**8. Orient the output inductor for lowest EMI.** Inductors have a “start” and an “end” on the winding. The start terminal is sometimes marked on the top of the body with a half-circle or dot (Figure 5). Because the start of the winding is buried by the total turns, it is somewhat shielded by those same turns. Orient the start of the winding so it connects to the switched output (often labeled “SW”) of the DC-DC converter IC. The end of the winding connects to the output filter, so it’s going to be quieter than the start of the winding.

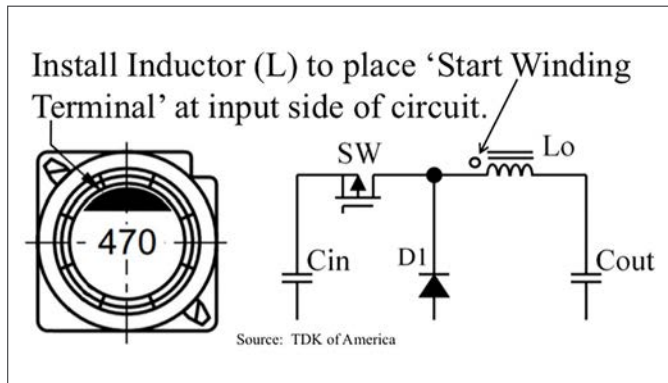

Figure 5 - Some ferrite inductors have a mark of some kind, such as TDK’s half-moon, indicating pin 1 (the start of the winding). (Image source: Rick Hartley Enterprises and TDK of America)

**9. The DC-DC converters will likely require local shields.** Despite the use of magnetically-shielded inductors, good PC board design, and layout practices, there will still be a strong H-, and especially E-fields, generated around the circuit loops and output induc-

tor. Design your PC boards to accommodate these local shields at the start by adding “fencing solder strips” connected to the GRP. If you don’t need them, great.

**10. Locate antennas and coax cables far from converter circuitry.** Antennas and their associated coax cables, if used) should be located as far as possible from DC-DC converters. The input circuit loop of large voltage drop buck converters will have a relatively high dV/dt and the associated electric field can couple directly into the receiver. Figure 6.

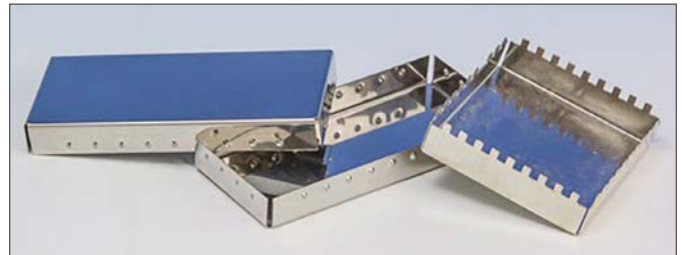

Figure 6 - Examples of local shields that can be soldered to designed-in fencing connecting to the GRP. These should be mounted over the DC-DC converter IC and associated circuitry.

**Note 1** - Some of TI’s older data sheets (examples below) recommend removing the GRP surrounding the output node (and sometimes the input node, as well) of their DC-DC converter designs or demo boards. This is incorrect, in my opinion, as noted above in Tip 4.

- SLVU437A (rev 7/2013) - TPS621X0-505 EVM series
- SLVSAG7E (rev 8/2016) - TPS62130-series
- SLVC394 - Gerbers for the TPS62130-series demo board

**REFERENCES**

1. Wyatt, Platform Interference - Measurement and Mitigation, Interference Technology, <https://interferencetechnology.com/platform-interference-measurement-mitigation/>
2. Wyatt and Sandler, Top Three EMI and Power Integrity Problems with On-Board DC-DC Converters and LDO Regulators, Interference Technology, <https://interferencetechnology.com/top-three-emi-power-integrity-problems-board-dc-dc-converters-l-do-regulators/>
3. Fast clock trace over gap in return plane (video), <https://www.youtube.com/watch?v=L44ITnQgv-o&t=9s>
4. André and Wyatt, *EMI Troubleshooting Cookbook for Product Designers*, SciTech Publishers, 2014.

# FCC LABEL CHANGES

---

**Ghery S. Pettit, iNCE**  
President, Pettit EMC Consulting LLC  
[Ghery@pettitemcconsulting.com](mailto:Ghery@pettitemcconsulting.com)



## FCC LABEL CHANGES

### INTRODUCTION

A while back the FCC changed their rules for approvals of digital devices. Included in those changes were a few changes to labeling requirements. This will serve as a review of what was required for many years and what the new processes are.

### A SHORT BIT OF HISTORY AND WHERE WE ARE TODAY.

In April of 2019, I wrote a blog article talking about the changes made by the FCC in 2017 to their rules covering approval processes for digital devices. Rather than go over the labeling requirements as they existed then, and then repeating them as they exist today, this blog will discuss both together and point out a key change. The most important change that you will see is the elimination of some old labels needed for products approved under the old Declaration of Conformity process.

### THINGS THAT CHANGED IN 2017 (AND MANY DID NOT)...

**Minor changes to some details, but the labels haven't changed.** Section 2.925 of the FCC Rules (Title 47 of the Code of Federal Regulations) is titled Identification of Equipment and deals specifically with products covered in an application for equipment authorization (Certification). It covers a number of points, but the key one to be remembered is the first one listed:

2.925(a)(1) - FCC Identifier consisting of the two elements in the exact order specified in §2.926. The FCC Identifier shall be preceded by the term FCC ID in capital letters on a single line, and shall be of a type size large enough to be legible without the aid of magnification.

The FCC Identifier described in 2.926 of the FCC Rules hasn't changed in years. The first part identifies the grantee and remains the same for that grantee. This section also details what happens if the grantee changes, for example through being purchased by a different entity. The equipment product code, the second part of the FCC Identifier, consists of alpha, numeric, and the dash or hyphen characters, and shall not exceed 14 characters in length. It also must not have been used previously by the grantee. This product code is provided by the grantee at the time of application. More details are provided in Section 2.926.

There have been some minor changes in 2.925 and 2.926 due to the changes in the approval processes in 2017, but nothing of any importance to the overall requirements.

**Minor changes in what approval processes require a label.** There was a requirement in Section 15.19(a)(3) of the FCC Rules that required a label on the product for

devices approved under Certification or Verification and a statement in the user manual if the product was approved using the Declaration of Conformity process. As Verification no longer exists, and the DoC process has become the Supplier's Declaration of Conformity process (with some changes), this statement now must be on a label on the product for both Certification and SDoC. The wording hasn't changed. It states:

"This device complies with Part 15 of the FCC Rules. Operation is subject to the following two conditions: (1) this device may not cause harmful interference, and (2) this device must accept any interference received, including interference that may cause undesired operation."

This warning is important for another reason. Unlike the European Union, which has mandatory immunity tests for products, the FCC only addresses immunity with this statement. The user isn't offered any protection against interference. Be aware.

**Labels that haven't changed.** There are separate user manual texts called out in the Rules for Class A and Class B products. These are quoted below for your use, but they have not been changed.

15.105(a) calls out the following text for Class A products:

"This equipment has been tested and found to comply with the limits for a Class A digital device, pursuant to Part 15 of the FCC Rules. These limits are designed to provide reasonable protection against harmful interference when the equipment is operated in a commercial environment. This equipment generates, uses, and can radiate radio frequency energy and, if not installed and used in accordance with the instruction manual, may cause harmful interference to radio communications. Operation of this equipment in a residential area is likely to cause harmful interference in which case the user will be required to correct the interference at his own expense."

15.105(b) calls out the following text for Class B products. Note that it also provides simple, useful troubleshooting advice for the user if interference is suspected:

"This equipment has been tested and found to comply with the limits for a Class B digital device, pursuant to Part 15 of the FCC Rules. These limits are designed to provide reasonable protection against harmful interference in a residential installation. This equipment generates, uses and can radiated radio frequency energy and, if not installed and used in accordance with the instructions, may cause harmful interference to radio communications. However, there is no guarantee that interference will not occur in a particular installation. If this equipment does cause harmful interference to radio or television reception, which can be determined by turning the equipment off and on, the user is encouraged to try to correct the

interference by one or more of the following measures:

- Reorient or relocate the receiving antenna.
- Increase the separation between the equipment and receiver.
- Connect the equipment into an outlet on a circuit different from that to which the receiver is connected.
- Consult the dealer or an experienced radio/TV technician for help.”

Finally, all products are required to have a statement in the user or instruction manual providing the following information, per Section 15.21 of the FCC Rules):

“Information to user. – The user’s manual or instruction manual for an intentional or unintentional radiator shall caution the user that changes or modifications not expressly approved by the party responsible for compliance could void the user’s authority to operate the equipment.”

Note that the exact wording of this warning is left up to the manufacturer of the device, but the message must be placed in the documentation.

It is also important to note that a number of these statements may be provided electronically to the user if the user may be expected to be able to read the electronic version.

#### **Old labels that are no longer called out in the Rules.**

Back before 2017 when the DoC process existed, there were special labels that went on products authorized under the DoC process. These were called out in 15.19(b)(1)(i) and 15.19(b)(1)(ii) of the FCC Rules. As the DoC process no longer exists, and these labels were not transferred over to the SDoC process, 15.19(b) is now

listed as “reserved”. These labels with the stylized FCC logo and the Trade Name/Model Number of the product are no longer called out in the Rules.

**Electronic labels.** Section 2.935, titled “Electronic labeling of radiofrequency devices” provides details on how electronic labeling may be done, and what is required. Basically, if a label is required and there is a display that can show it, you can label the product electronically on the display. You must provide instructions to the user on how to bring up these labels on the display. You still have to provide a stick-on label showing the FCC identifier if there is one, but there are relaxed requirements for this label. Take a look at 47CFR2.935 for more details.

The FCC has a summary of the new (as of November 2017) requirements on their website at <https://www.fcc.gov/testing-laboratory-qualifications#block-menu-block-4>. Take a look. Also, all the referenced sections of the FCC Rules are in Title 47 of the Code of Federal Regulations. You can find an electronic version of all the CFR titles at <https://www.ecfr.gov/cgi-bin/ECFR?page=browse>. This website should keep you busy for days just looking at “stuff”.

#### **CONCLUSION**

This is only a summary of the changed labeling requirements. Some didn’t change, others changed in a minor way and a couple others disappeared completely. These, as can be seen, are scattered around the FCC Rules and are not in a single, convenient location. That is no change from the past.

I hope you find this summary useful. As noted in the previous blog, a good consultant can help you wade through these requirements and answer any questions that you may have. Please contact one if you have any questions.



# PC BOARD DESIGN FOR WIRELESS PRODUCTS

---

**Kenneth Wyatt**  
Wyatt Technical Services, LLC  
*ken@emc-seminars.com*

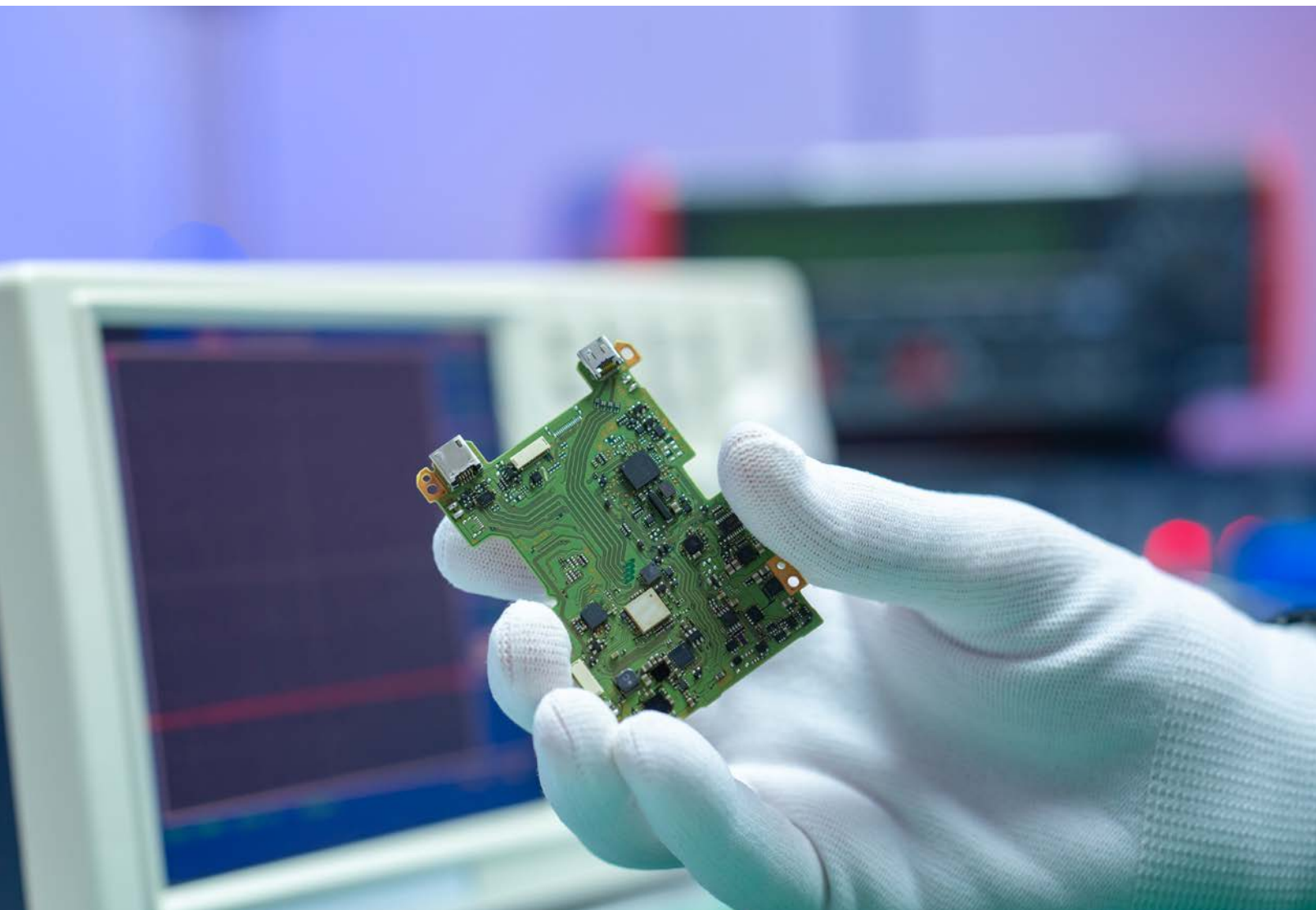

## PC BOARD DESIGN FOR WIRELESS PRODUCTS

### INTRODUCTION TO SELF-GENERATED EMI

It seems many manufacturers these days are developing products that incorporate wireless technologies — both in new and existing products. Many of these products are using LTE cellular connectivity and designers are finding that the on-board DC-DC converters and processor/memory bus noise are creating enough broadband electromagnetic interference (EMI) that the cellular receiver downlink channels are being desensed (decreased sensitivity) to a point where the product is non-compliant with the cellular provider's sensitivity requirements. Sometimes this broadband EMI even extends up to the GPS bands of 1575.42 MHz affecting navigational performance.

Cellular providers have strict receiver sensitivity requirements and the Total Isotropic Sensitivity (TIS) is one of the tests performed during CTIA compliance. If the receiver is not sensitive enough, the product will not be allowed onto the cellular system (*References 1 and 2*).

### WHY PROPER PC BOARD DESIGN IS KEY

One factor that is always key to low-EMI designs is proper PC board design. If high-speed signals are not captured within transmission line structures, common mode current generation, EMI radiated leakage and crosstalk can result. Very often, I find clients use layer stack-up designs suggested in the 1990s for modern wireless designs of today and this is just asking for trouble, with associated schedule delays, debugging, and repeated compliance testing.

In order to understand why proper PC board design is a major key to success, let's first understand how high-speed signals move in circuit boards.

### HOW SIGNALS MOVE IN PC BOARDS

I suspect many of us were taught in university or college that electric current was the flow of electrons in copper wires or circuit traces, and that signals travelled at near the

speed of light. This is inaccurate. It was also unlikely we were taught much about how signals propagated in circuit board transmission lines during our fields and waves class.

Before you can understand how signals propagate in PC boards, you must first understand some physics (*References 3 and 4*).

This current flow is partially true, of course, for DC circuits (with exception of the initial battery connection transient). But for AC (or RF) circuits or for the switching transients from switch mode power supplies, we need to understand all connecting wires/traces must now be considered transmission lines.

First, let's consider how capacitors seemingly allow the "flow" of electrons. Referring to *Figure 1*, if we apply a battery to the capacitor, any positive charges applied to the top plate will repel positive charges on the bottom plate, leaving negative charges. If we apply an AC source to the capacitor, it might seem as if the current flows through the dielectric, which is impossible. James Clerk Maxwell called this "displacement current," where positive charges merely displace positive charges on the opposite plate leaving negative charges, and vice versa. This displacement current is defined as  $dE/dt$  (changing E-field with time).

Electrons and the positively-charged holes do not travel at near light speed in copper as was implied, but move at about 1 cm/sec, due to the very tight atomic bond of the copper molecules (*Reference 4*). There are certainly clouds of free electrons and holes, but these move slowly from molecule to molecule. This is called conduction current and is what we would measure with an ammeter. Conduction current is related to the tangential component of the B-field, that is the  $curl B = J$ .

The influence of one electron in the copper molecule to its neighbor (and on down the transmission line) propagates at the speed of the electromagnetic (EM) field in the dielectric material. In other words, jiggle one electron

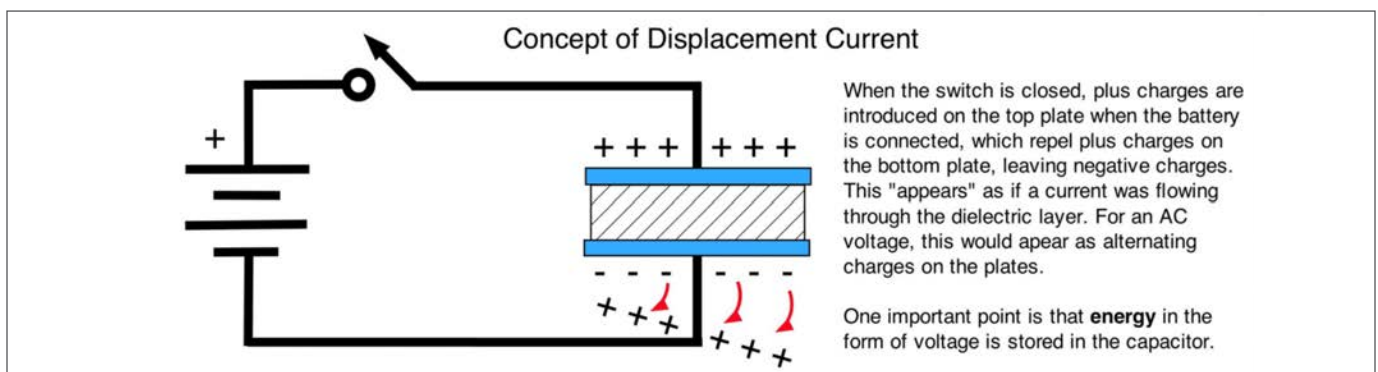

Figure 1. The concept of displacement current through a capacitor.



at one end of a microstrip and it jiggles the next, which jiggles the next, and so on, until it jiggles the last one at the load end of the transmission line. This jiggling is called a kink in the E-field and can be envisioned as the Newton's Cradle toy, a mechanical analogy, where the first ball hits the next and this eventually pops off the end ball (Figure 2).



Figure 2. Newton's Cradle is a good analogy to EM field signal propagation in the dielectric of a circuit board.

Let's now consider a digital signal with a wave front moving at about half light speed (about 6 in/ns in FR4 dielectric) along a simple microstrip over an adjacent ground return plane (GRP) as illustrated in Figure 3.

The next important point is that the **EM field of the digital signal travels in the dielectric space**—not the copper. The copper merely “guides” the EM wave (References 4 and 5).

When the signal (EM wave) is first applied between the microstrip and GRP, it starts to propagate along the transmission line formed by the microstrip over an adjacent GRP. There is a combination of conduction current and displacement current (across the dielectric).

EMI harmonics originate at the wave front as the EM wave propagates. The fast rise or fall times of the signal contain all the harmonic energy and this is what creates the EMI.

If the load impedance is equal to the characteristic impedance of the transmission line, then there will be no reflections of the EM wave back to the source. However, if there is a mismatch, there will be reflected EM fields propagating back to the source. In reality, most realistic digital signals will have multiple reflections moving back and forth through the transmission line simultaneously. The transition zone (rise time or fall time) of these propagating waves will potentially produce EMI.

**PHYSICS-BASED RULES FOR TRANSMISSION LINES**

With a better understanding of how signals move in circuit boards, there are two very important principles when

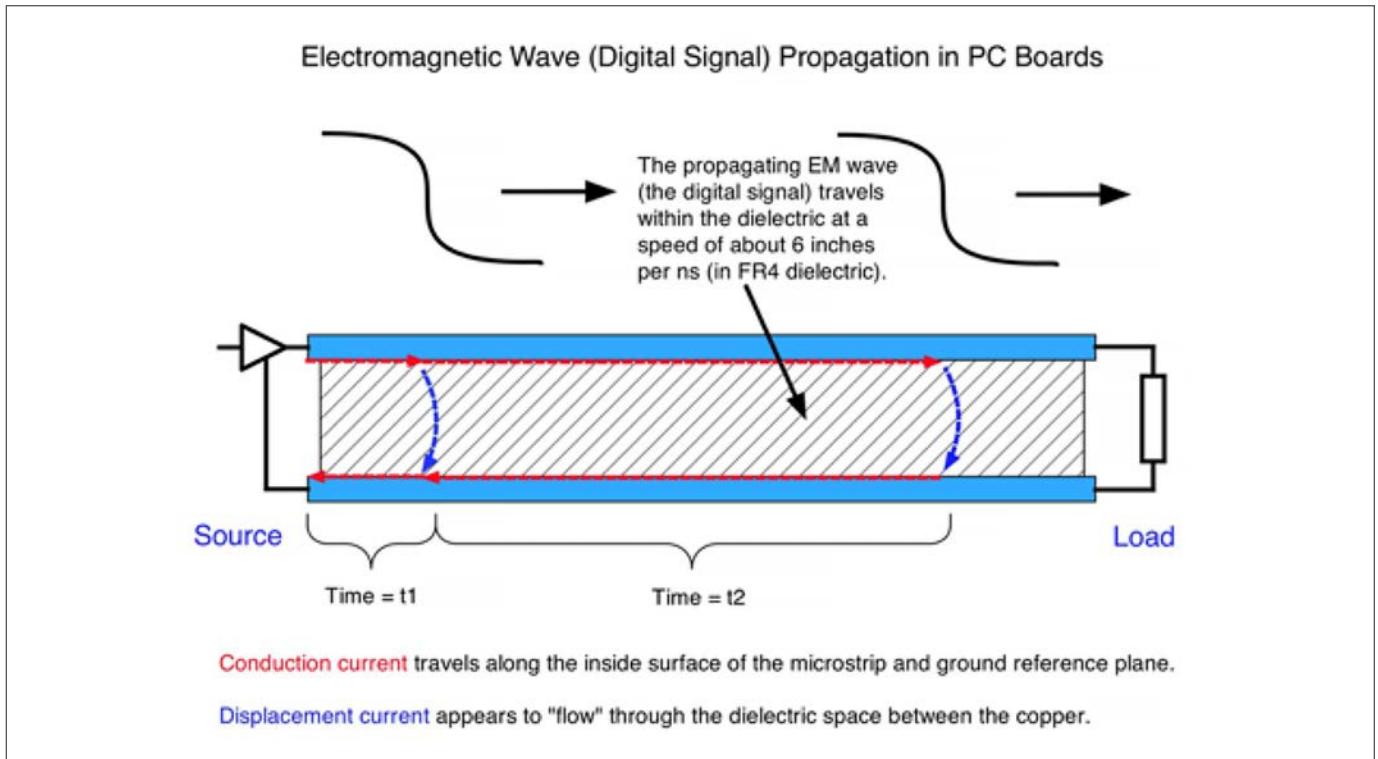

Figure 3. The digital signal (an electromagnetic wave) travels through the dielectric space between the microstrip and ground reference plane (GRP).

it comes to low EMI PC board design:

1. Every signal and power trace (or plane) on a PC board should be considered a transmission line.
2. Digital signal propagation in transmission lines is really the movement of electromagnetic fields in the space between the copper trace and GRP.

To construct a transmission line, you need two adjacent pieces of metal that capture or contain the field. Examples include a microstrip over an adjacent GRP or a stripline adjacent to a GRP or a power trace (or plane) adjacent to a GRP. Locating multiple signal layers between power and ground reference planes will lead to real EMI issues for fast signals.

**IMPORTANT POINT #1 - In other words, every signal or power trace (routed power) must have an adjacent GRP and all power planes should have an adjacent GRP.** Many products end up violating these two rules, with resulting EMI issues.

**IMPORTANT POINT #2 -** If you break the path of conduction current in the GRP through a gap or slot, we

start to get “leakage” of the signal EM field throughout the dielectric space, which leads to edge radiation from the board and cross-coupling to other circuits through via-to-via coupling. This also occurs when we pass a signal through multiple ground reference or power planes if there is no nearby return path adjacent stitching via or stitching capacitor (to connect GRP to power planes). This self-generated EMI can easily conductively couple or radiate into sensitive cellular receivers. Please refer to the video demo explaining why gaps in the GRP are a disaster for EMI (*Reference 6*).

*Via penetration:* Very often, signals need to be run from the top side to the bottom side (or interior-to-interior layers), relying on vias to get there. If you only need to pass from one side of a GRP to the other, there’s no issue, because the electromagnetic field of the signal is contained between a constant metallic transmission line along the entire path (*Figure 4*).

It’s only when you need to pass through multiple planes that many designs fail to provide a continuous return path for the electromagnetic wave as it travels through the dielectric space of the board (*Figure 5*).

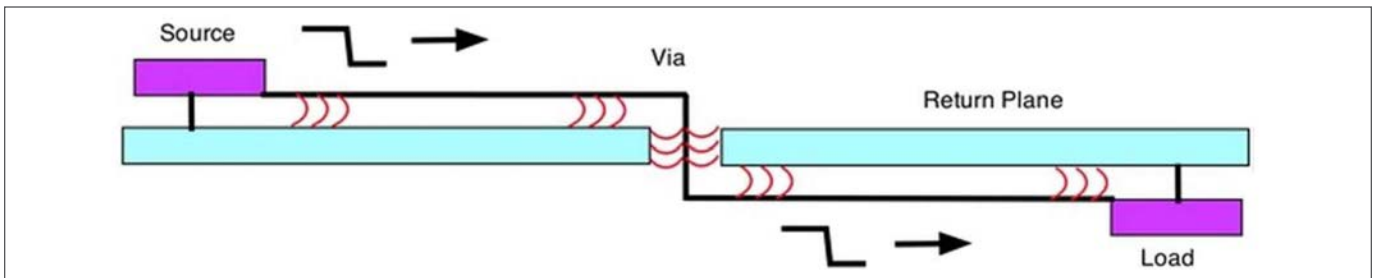

Figure 4. Passing a signal trace through a single GRP allows field propagation along the entire path. The dielectric layer is not shown for clarity and the field propagation is represented by the red “waves.”

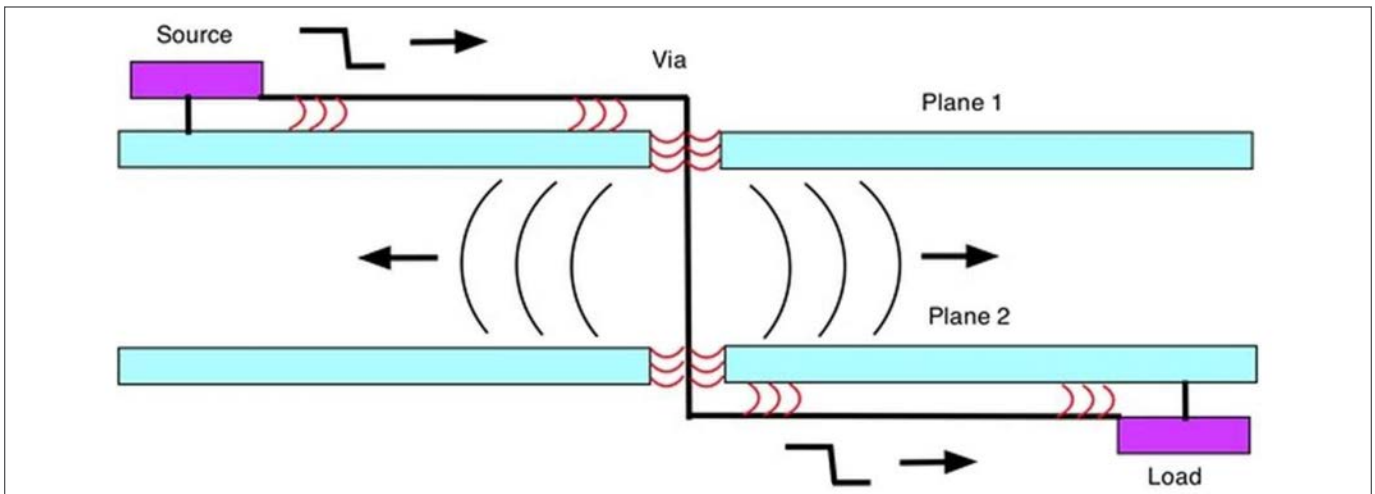

Figure 5. Passing a signal trace through two planes results in field leakage within the dielectric space, unless a defined path for return current is added. The dielectric layer is not shown for clarity and the field propagation is represented by the red “waves.”

A lack of transmission-line continuity between the planes (using a stitching via or capacitor), will result in field leakage throughout the dielectric space as the signal tries to find a way back to the source. This field energy will couple to other vias, as well as propagate out as “edge radiation.”

If the two planes are GRPs, then you need to merely stitch them together in at least one location near the signal via. This allows field propagation along the entire path. A matrix of ground vias is always a good practice and if they’re located very close together (5 mm spacing is good), there’s no need to specifically locate one at each penetration.

A challenge presents itself when the two planes are at different potentials, such as a GRP and power, then a stitching capacitor needs to be installed next to the signal via. If there are dozens of signal penetrations on such a board, it may be impractical to add a stitching capacitor for every signal penetration, so that’s one reason to locate an even distribution of decoupling/stitching capacitors throughout the board. This will also help reduce “ground bounce” or simultaneous switching noise (SSN).

**PROPER BOARD STACK-UP FOR LOW EMI**

Observing these two important rules will dictate the layer stack-up. Following are some good and not so good EMI designs. More information on this topic may be found in *References 7 and 8.*

**FOUR-LAYER BOARD: POOR (BUT TYPICAL) EXAMPLE**

A typical four-layer board design I see often is (top to bottom): Signal - Ground Return Plane - Power Plane - Signal. This worked OK decades ago with relatively slow clock and signal frequencies, but is just asking for EMI issues in today’s high frequency wireless technology. Let’s show a couple four-layer examples that follow the rules. Note the lack of power planes.

**FOUR-LAYER BOARD: GOOD DESIGN 1**

Here is an example of a good four-layer board stack-up for improved EMI (*Figure 6*). Instead of a power plane, we use either routed or poured power, along with signals on layers 2 and 3. Thus, each signal/power trace is adjacent to a GRP. Also, it’s easy to run simple vias between all layers, so long as the two GRPs are also connected

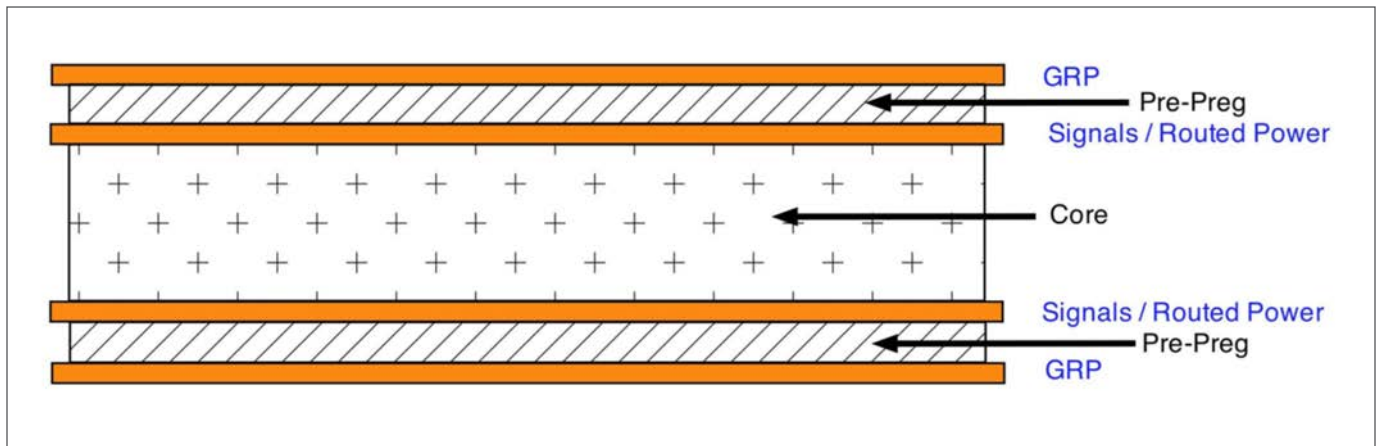

Figure 6. This good four-layer board stack-up for improved EMI keeps the signals and routed power near the ground reference planes.

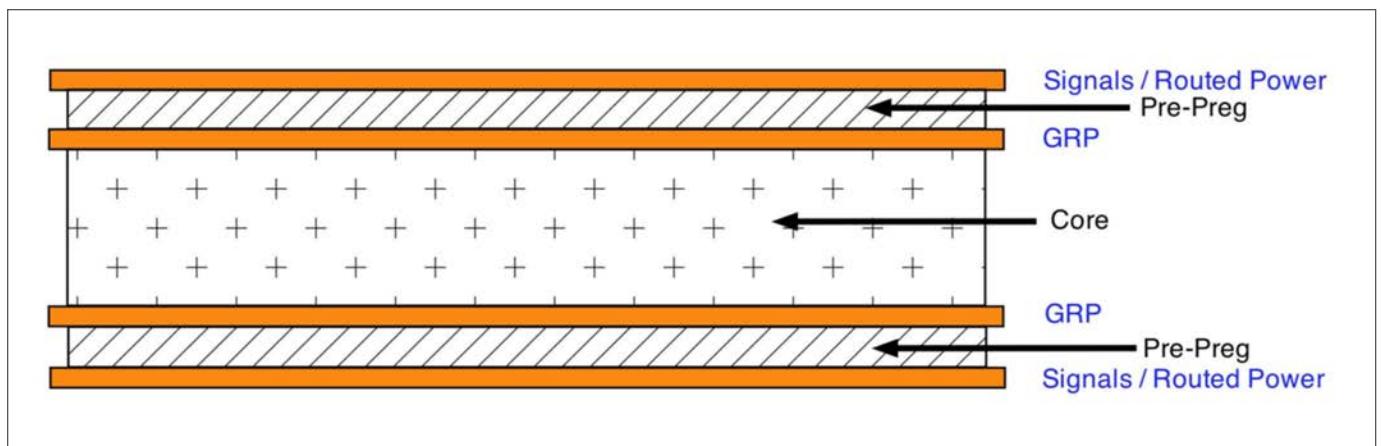

Figure 7. This good four-layer board stack-up for improved EMI places the ground reference planes inside the board.

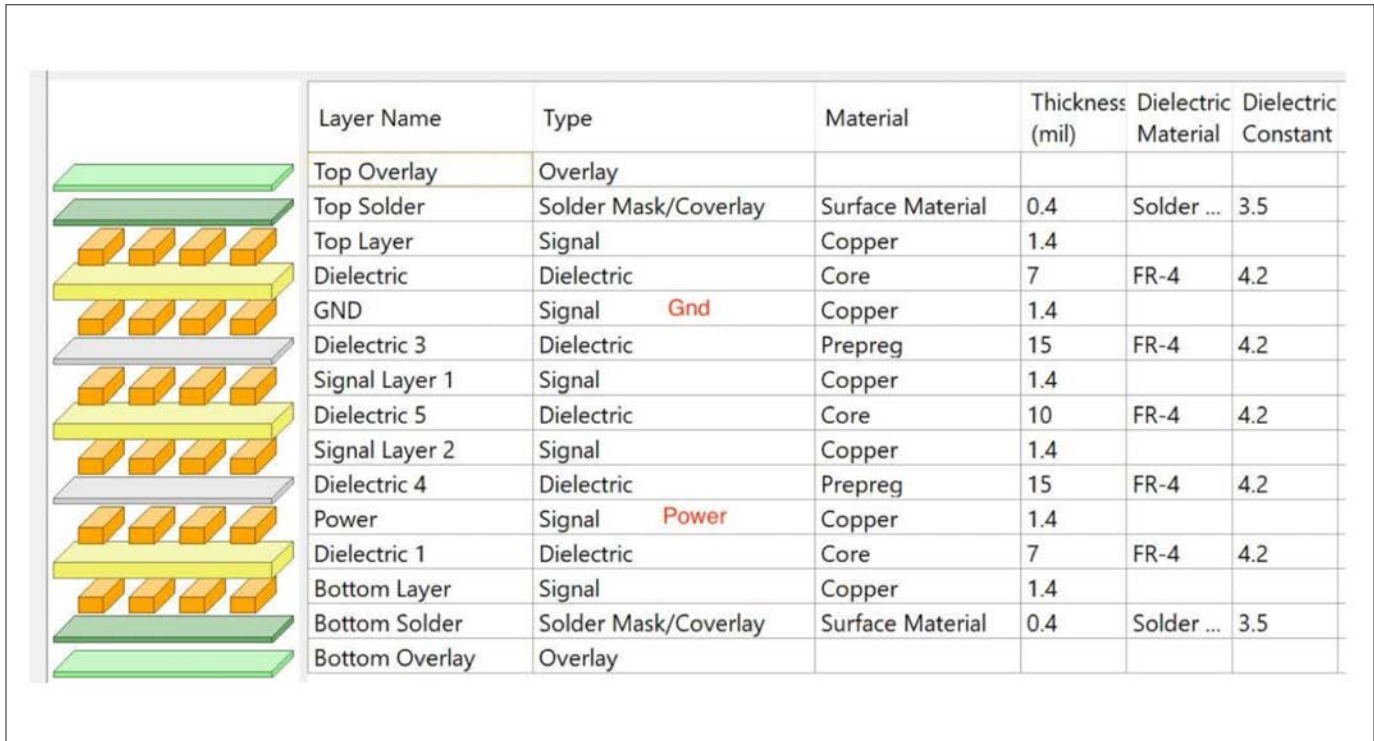

Figure 8. A very common, but poor, EMI six-layer stack-up design.

together with a matrix of stitching vias. If you run a row of stitching vias along the perimeter (say, every 5 mm) you form a Faraday cage. This is an excellent option for critical wireless products.

**FOUR-LAYER BOARD: GOOD DESIGN 2**

If, on the other hand, you'd prefer to have access to the signal and routed/poured power traces, you may simply reverse the layer pairs, such that the two GRP layers are in the middle and the two signal layers are positioned at the top and bottom, with routed power and sufficient decoupling caps, rather than a power plane (Figure 7, see page 27).

For both four-layer designs, you want to run a 5-mm matrix pattern of stitching vias connecting the two GRPs.

For routed or poured power, every digital device will need 2-3 decoupling capacitors per power pin, or tight groupings of pins. In addition, rails (typically the main digital voltages) should have wider pours around any high *dI/dt* devices, such as core voltage, drivers, ASICs, motor controllers, processors, etc. This will help serve as your high frequency decoupling.

**TYPICAL SIX-LAYER DESIGN: POOR EXAMPLE**

One stack-up I frequently see is this six-layer design (Figure 8). This probably worked well enough in the a decade or two ago, but like the poor four-layer design, is recipe for EMI disaster. There are two issues with this: the bot-

tom two signal layers are referenced to the power plane and the power and ground return planes are non-adjacent and too far apart for best EMI decoupling.

With few exceptions (some DDR RAM power and signals, for example) currents want to return to their sources, which are referenced to the GRP. Referencing these signals to the power plane is very EMI-risky, because there is no clearly defined return path, except through plane-to-plane capacitance, which in this case, is relatively small. In addition, the indefinite return path can result in field leakage into other areas of the board's dielectric layers. That, in turn, leads to cross-coupling into wireless receivers and other circuitry and radiated EMI.

The second issue occurs when we have the power and GRP separated by two signal layers. Any power distribution network (PDN) transients will cross-couple to any signal traces on layers 3 and 4 within the dielectric layers. You also lose any plane-to-plane capacitance decoupling benefit if these planes are separated by more than 3-4 mils.

**EIGHT-LAYER BOARD (GOOD EXAMPLE)**

Both the four- and eight-layer board design examples (Figures 6, 7, and 9: for Figures 6 and 7, see page 27, and for Figure 9, see page 29) follow the two fundamental rules (IMPORTANT POINT #1) that preserve good transmission line design and resulting low EMI. In addition, for the eight-layer design, the power and GRP planes are now 4 mils apart, providing good plane-to-plane capac-

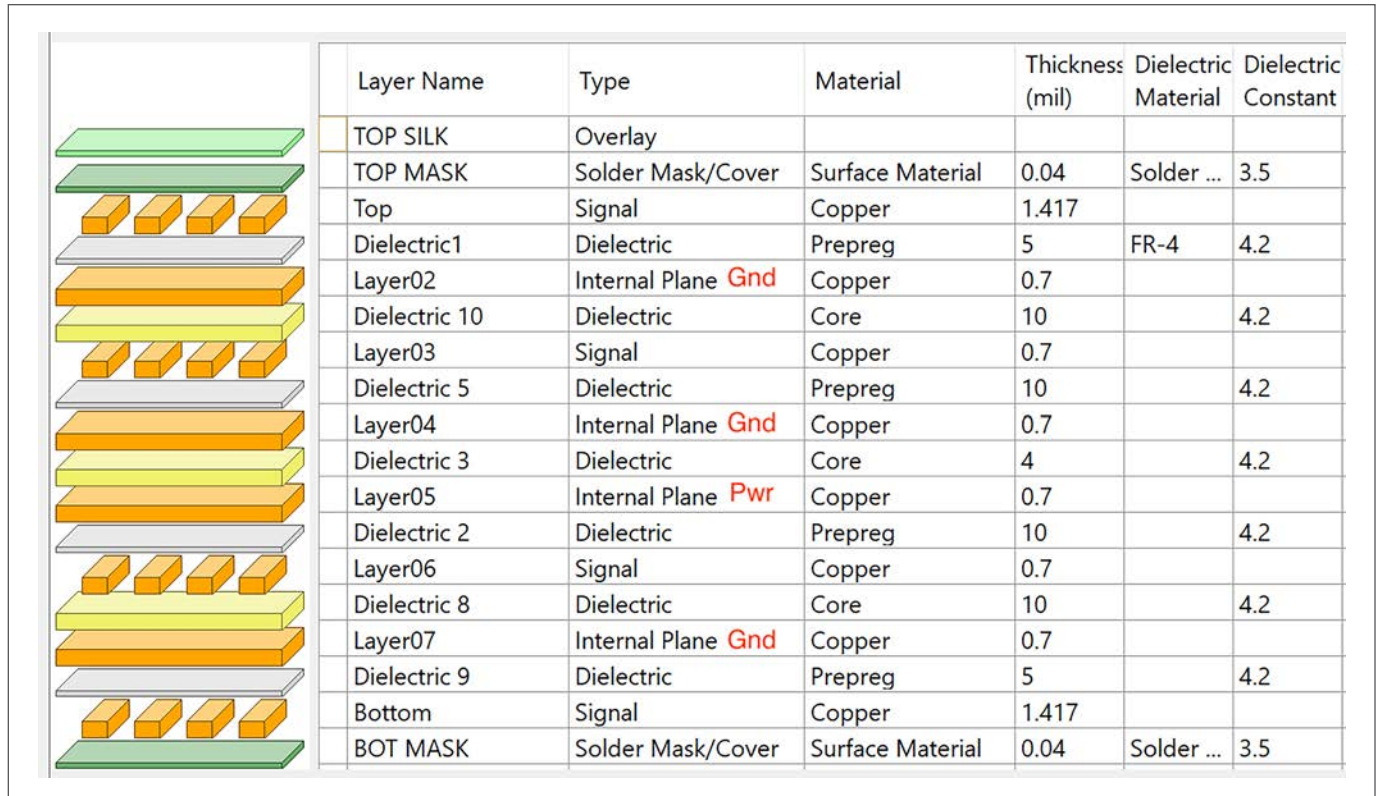

Figure 9. A good EMI stack-up design (8-layer example). All signal layers are referenced to an adjacent GRP, while power is also referenced to an adjacent GRP.

itance. Closer spacing would be even better. For example, a spacing of 1 mil to 3 mils is ideal for minimizing EMI. Multiple GRPs should be stitched together with a 5-mm matrix pattern of vias.

Of course, there are many more iterations on creating proper transmission line pairs between signal and GRP or power and GRP.

**PARTITIONING OF CIRCUIT FUNCTIONS**

The next most important consideration when laying out the circuitry for your wireless board is partitioning of circuit functions, such as digital, analog, power conversion, RF, and motor control or other high-power circuits.

To avoid signal coupling and crosstalk, you must not allow the various return signals from intermixing within the same dielectric space. Thus, you need to partition major circuit functions. *Figure 10* (see page 30) demonstrates one example of partitioning. Of course, this gets more challenging as board size shrinks. Henry Ott also describes this concept in *Reference 9*.

Another way to separate noisy circuits, such as digital and power conversion, from analog and RF circuitry is to locate the digital on the bottom side of the stack-up and the analog and RF modules on the top side. For practical applications, this often assumes at least an eight layer

design with one, or more, GRPs near the middle to isolate the top and bottom sides. Great care must be taken to avoid coupling noisy circuitry with sensitive receivers, in the case of wireless designs.

Because low frequency (less than 50 kHz) or audio signal return currents tend to spread out more, that circuitry must be separated from digital, power conversion, or motor controller circuits. Likewise, sensitive RF receiver circuits, such as GPS, cellular, or Wi-Fi devices must also be kept separate from noisy digital, power conversion, or motor controller circuitry.

While *Figure 10* implies routed power, it is very common to use 3.3V power planes under the digital circuitry for good EMI suppression. Power can also be routed as polygons under the appropriate circuit sections.

**ADDITIONAL TIPS**

**Multiple ground vias:** It's a good practice to create a matrix of ground vias connecting GRPs together using a spacing of about 5-mm. This will provide multiple return paths for signals penetrating more than one GRP layer. In addition, if you use multiple GRPs, you should design via stitching all around the periphery of the board to create a Faraday cage for those signal layers in between. This technique is especially useful when incorporating wireless technology in the design.

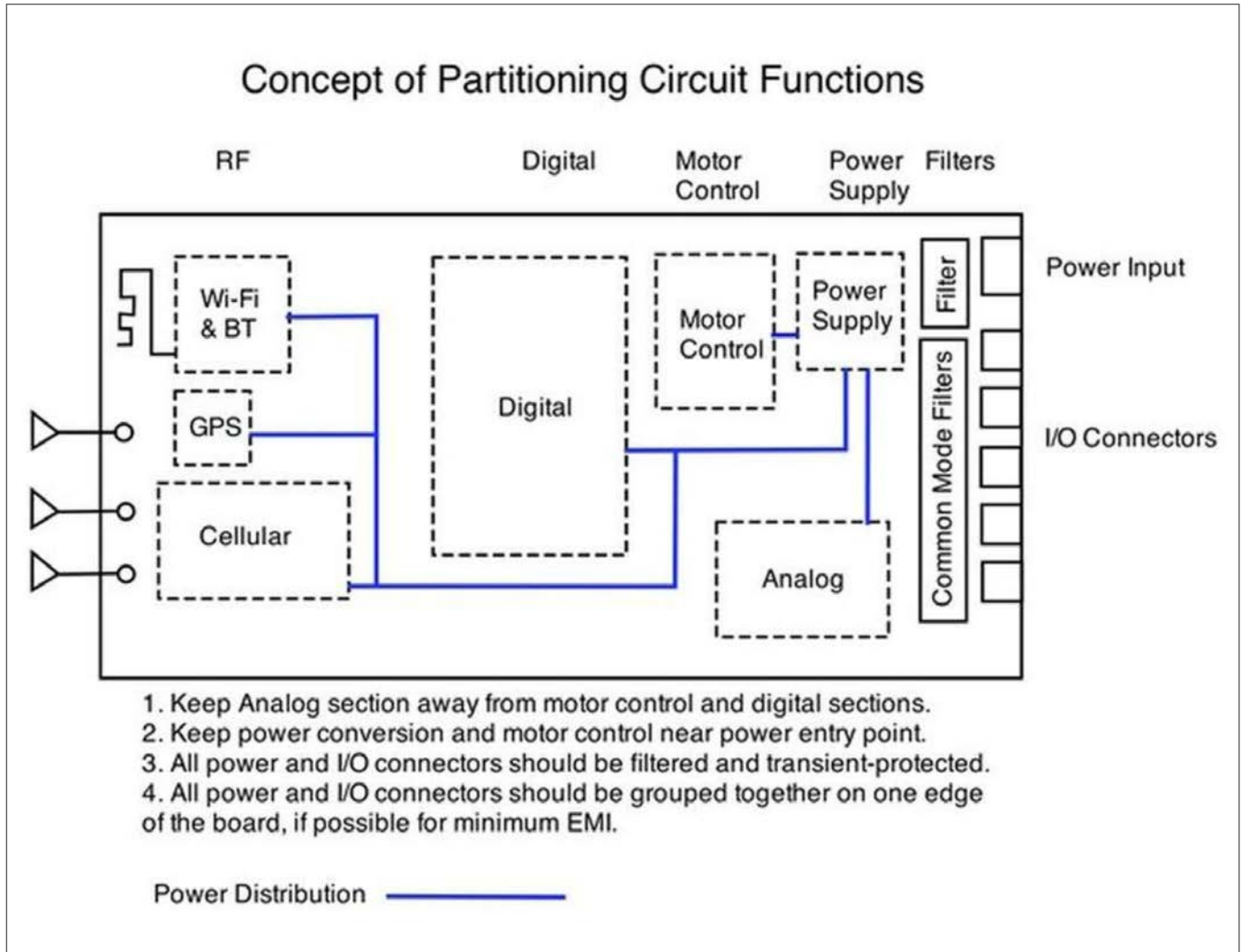

Figure 10. An example of how to partition circuit functions on a board.

**Ground fills:** While it seems to be a fairly common practice to fill in unused areas within each layer with ground fills, besides being unnecessary, they can lead to the issue of the “trace crossing a gap in the return” problem for dense boards where all the transmission line rules may be difficult to achieve. Eric Bogatin explains this a bit more in *Reference 10*.

**Routed power versus power planes:** The conventional method is to start with one or more (depending on the number of layers) power-ground “cores” and build the signal layers from there, usually equally on each side of the core for best manufacturability. Typically, digital ground return is used for this. Another big advantage is that when spaced very close together (less than 3 mils), the power-ground core becomes a good high-frequency decoupling capacitor. As the number of layers increase, it’s often best to locate two or more power-ground cores closer to the top and bottom of the stack-up — generally on layers 2-3 and 6-7 (on eight-layer boards, for example).

### CONCLUSION

Most wireless products, especially smaller portable/mobile devices, now require greater care in their overall system design. An important key to low EMI and consequently, optimum performance, is the design of the PC board. You can largely “throw out” the layout rules used in past years, because at the clock and signal speeds used today, all copper traces become transmission lines and require more care to avoid gaps in the signal path where the electromagnetic wave can “leak out” and couple to sensitive circuits.

The important points to remember are that all signal and power networks should now be considered as transmission lines, the signals and power transients travel at about half light speed within the dielectric space, the copper traces “guide” the signals along the GRP, and circuit functions need to be partitioned across the board real estate in order to reduce coupling. Maintaining these guidelines will help assure the lowest EMI and best performing wireless designs.

### REFERENCES

1. CTIA, Test Plan for Mobile Station Over the Air Performance: Method of Measurement for Radiated RF Power and Receiver Performance, [http://files.ctia.org/pdf/CTIA\\_OTA\\_Test\\_Plan\\_Rev\\_3.1.pdf](http://files.ctia.org/pdf/CTIA_OTA_Test_Plan_Rev_3.1.pdf)
2. Broadcom, Compliance with TIS and TRP Requirements, <https://www.broadcom.com/collateral/wp/21XX-WP100-R.pdf>
3. Schmitt, Electromagnetics Explained - A Handbook for Wireless/RF, EMC, and High Speed Electronics, Newnes, 2002.
4. Bogatin, Signal Integrity - Simplified (3rd edition), Prentice Hall, 2018.
5. Beeker, Effective PCB Design: Techniques To Improve Performance, [https://www.nxp.com/files-static/training\\_pdf/WBNR\\_PCBDESIGN.pdf](https://www.nxp.com/files-static/training_pdf/WBNR_PCBDESIGN.pdf)
6. Wyatt, Gaps in Return Planes (video), <https://www.youtube.com/watch?v=L44ITnQgv-o&t=9s>
7. Hartley, Control of Noise, EMI and Signal Integrity in PC Boards (2-day seminar), Rick Hartley Enterprises, managed by <https://www.pcb2day.com>.
8. Morrison, Fast Circuit Boards - Energy Management, Wiley, 2018.
9. Ott, Electromagnetic Compatibility Engineering, Wiley, 2009.
10. Bogatin, Seven Habits of Successful 2-Layer Board Designers (Signal Integrity Journal), <https://www.signalintegrityjournal.com/blogs/12-fundamentals/post/1207-seven-habits-of-successful-2-layer-board-designers>

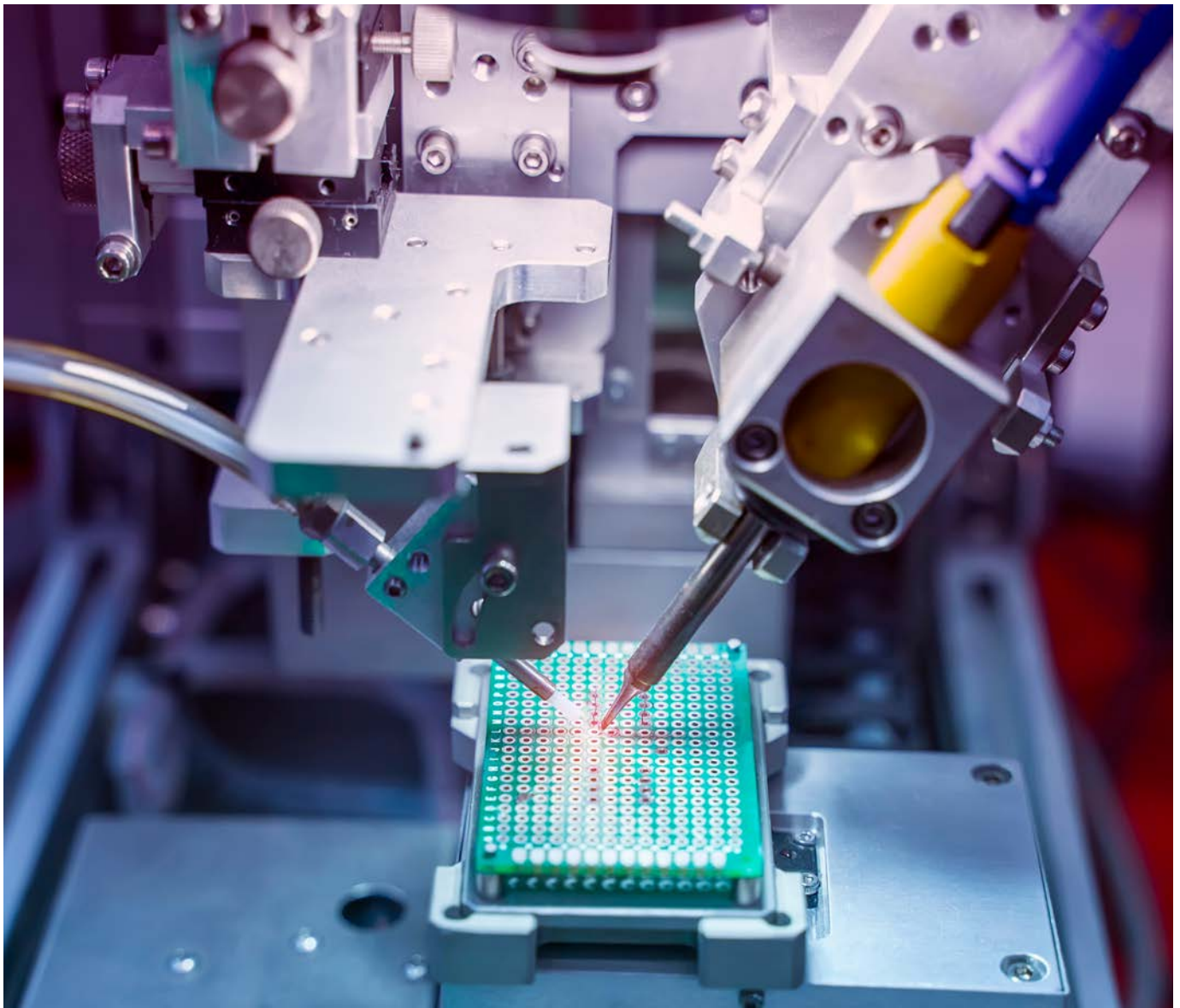

# INTEGRATED PASSIVE COMPONENTS (IPCS) SIMPLIFY SIGNAL CONDITIONING IN PACKAGE THAT IS 20% THE SIZE

---

**Manuel Carmona**  
Johanson Technology

*The company manufactures a variety of high frequency ceramic components including chip antennas, High-Q capacitors and EMI chip filters.*

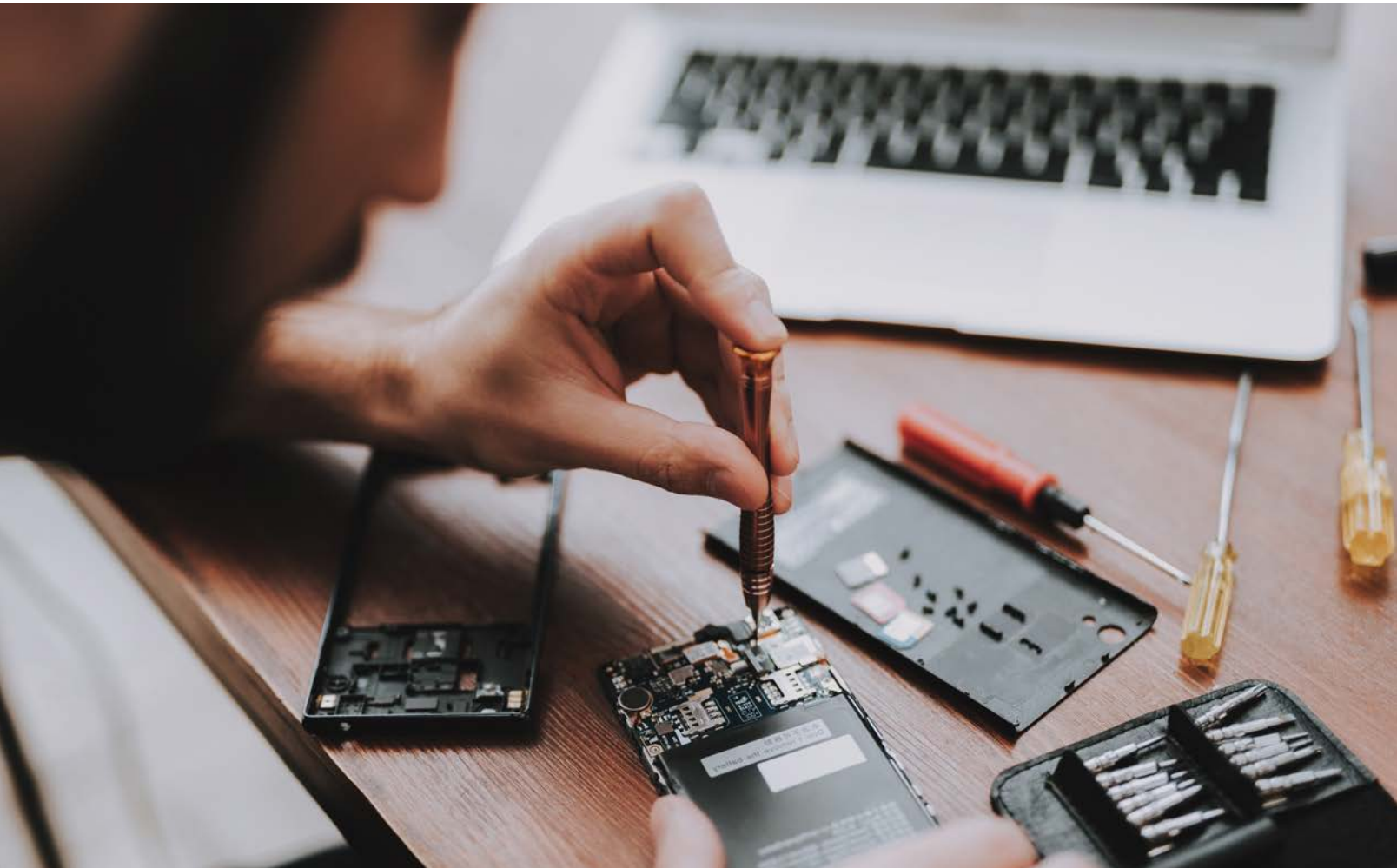



## INTEGRATED PASSIVE COMPONENTS (IPCS) SIMPLIFY SIGNAL CONDITIONING IN PACKAGE THAT IS 20% THE SIZE

With PCB real estate at a prime, the size and placement of the passive components are critical, because as everything gets smaller it becomes increasingly difficult to place more components on the board. Therefore, design engineers in the automotive, medical, mobile electronics, and “smart” wearables industries are looking to component manufacturers to deliver miniaturized solutions that occupy next to no real board space.

As a result, Integrated Passive Components (IPCs) are increasingly attractive, due to the miniaturization of wireless devices and the need to increase reliability of signal conditioning in RF circuits such as filtering, impedance matching, differential to single ended conversion, and coupling.

IPCs are essentially electronic sub-systems that combine multiple discrete passive components into a single surface mounted device. Manufactured using Low Temperature Cofired Ceramic (LTCC) technology that allows the passive components to be layered “three-dimensionally,” IPCs deliver the same functionality as 10-40 individual components, while dramatically reducing the board space required.

With this approach, the entire front-end between the RF chipset and the antenna can be manufactured in a single, ultra-low profile (0.35-1.0 mm total thickness) package that is less than 20% the total size of the same circuit comprised of discrete components.

Because IPCs require much less board space, smaller miniaturized devices with RF circuitry can be designed and smaller form-factor products created.

For customers less concerned with board space or overall size, IPCs deliver another significant benefit — greater reliability. By creating a literal circuit within a small LTCC package, variability and potential points-of-failure are all but eliminated when compared to mounting many discrete components.

The elimination of components on a 10:1 or greater basis also reduces the overall weight of devices, even if that savings is measured in tenths of grams.

These factors have major implications for next generation smart wearables (rings, bracelets, shoes, jeans, shirts, and other apparel), implantable medical devices and portable electronics. As it relates to greater reliability, the automotive industry is already utilizing IPCs for on-board cellular, Wi-Fi, Bluetooth, satellite radio, and GPS systems, as well as key fobs.

## LTCC TECHNOLOGY

The process to manufacture IPCs is similar to the technology already used to create multi-layer SMD component parts, such as capacitors and inductors. However, a proprietary low temperature co-fired ceramic (LTCC) developed by Johanson Technology allows circuits to be embedded in as many as 40 separate layers in a three-dimensional package that is still very low profile.

Using this manufacturing process, small and highly reliable IPCs for RF systems can be manufactured for almost any type of passive circuit, including low and high pass filters, diplexers, triplexers, impedance matched baluns, balun-filters band pass filters, couplers, and other custom signal conditioning circuits. The components operate over several bands from 300 MHz to 10 GHz covering Cellular, DECT, WLAN, Bluetooth, 802.11 (a, b, and g), and GPS applications.

Each integrated package is thoroughly 100% RF tested to ensure all the components are working properly and are integrated together. This approach ensures that the IPC is a passive subsystem that is guaranteed to pass its RF performance requirements with FCC, ETSI, and any other emission regulation.

One prime example of the IPC concept is for match-filter baluns. A balun is an electrical device that converts between a balanced (differential) and unbalanced (single-ended) signal. The component can take many forms and may include devices that also transform impedances.

Because many RF wireless chipsets have differential (two pins) outputs — an RF input and output — that connect to a single-ended antenna, the signal needs to be converted from differential to single ended in a specific impedance ratio, most of the time these wireless RFICs have a non-standard complex impedance which the IPC’s match for optimum power efficiency. Some baluns are also combined with a bandpass, low pass, or high pass filters.

To accomplish an impedance conjugate match, IPC manufacturers can work with chipset OEMs to create a specific Match-Filter Baluns with a matching part number for each chip. The collaboration begins with reference designs during development to simplify and speed-up adoption of the chipset in the market. By working with the leading chipset manufacturers, the R&D to ensure it is optimized for that specific chip is already completed and that it will comply with any emission requirements.

For more information, contact Johanson Technology at (805) 389-1166, e-mail [antenna@johansontechnology.com](mailto:antenna@johansontechnology.com) or visit [www.johansontechnology.com/ant](http://www.johansontechnology.com/ant). The company is located at 4001 Calle Tecate, Camarillo, CA 93012.

# WIRELESS GROUPS & ORGANIZATIONS

## MAJOR WIRELESS LINKEDIN GROUPS

- Wireless Telecommunications Worldwide
- Wireless and Telecom Industry Network
- Cellular, Wireless & Mobile Professionals
- Wireless Communications & Mobile Networks
- 802.11 Wireless Professionals
- Wireless Consultant
- Telecom & Wireless World

## WIRELESS ASSOCIATIONS AND ORGANIZATIONS

### APCO International

<https://www.apcointl.org>

APCO International is the world's oldest and largest organization of public safety communications professionals and supports the largest U.S. membership base of any public safety association. It serves the needs of public safety communications practitioners worldwide — and the welfare of the general public as a whole — by providing complete expertise, professional development, technical assistance, advocacy and outreach.

### ATIS

<http://www.atis.org>

In a rapidly changing industry, innovation needs a home. ATIS is a forum where the information and communications technology (ICT) companies convene to find solutions to their most pressing shared challenges.

### Bluetooth Special Interest Group

<https://www.bluetooth.com>

Join thousands of the world's most innovative companies already developing and influencing Bluetooth technology.

### CTIA - The Wireless Association

<http://www.ctia.org>

CTIA is an international nonprofit membership organization that has represented the wireless communications industry since 1984. The association's members include wireless carriers, device manufacturers, suppliers as well as apps and content companies.

### ETSI - European Telecommunications Standards Institute

<http://www.etsi.org>

We produce globally applicable standards for Information & Communications Technologies including fixed, mobile, radio, broadcast, internet, aeronautical, and other areas.

### NAB - National Association of Broadcasters

<http://nab.org>

The National Association of Broadcasters is the voice for the nation's radio and television broadcasters. As the premier trade association for broadcasters, NAB advances the interests of our members in federal government, industry and public affairs; improves the quality and profitability of broadcasting; encourages content and technology innovation; and spotlights the important and unique ways stations serve their communities.

### Satellite Industry Association

<http://www.sia.org>

The Satellite Industry Association (SIA) is a Washington D.C. based trade association representing the leading global satellite operators, service providers, manufacturers, launch services providers, and ground equipment suppliers.

### Telecommunications Industry Association

<http://www.tiaonline.org>

The Telecommunications Industry Association (TIA) is the leading trade association representing the global information and communications technology (ICT) industry through standards development, policy initiatives, business opportunities, market intelligence and networking events. With support from hundreds of members, TIA enhances the business environment for companies involved in telecom, broadband, mobile wireless, information technology, networks, cable, satellite, unified communications, emergency communications, and the greening of technology.

### Wireless Infrastructure Association (WIA)

<http://wia.org>

The Wireless Infrastructure Association represents the businesses that develop, build, own, and operate the nation's wireless infrastructure.

### Wireless Innovation Forum

<http://www.wirelessinnovation.org>

WInnForum members are dedicated to advocating for the innovative use of spectrum and advancing radio technologies that support essential or critical communications worldwide. Through events, committee projects, and initiatives the Forum acts as the premier venue for its members to collaborate to achieve these objectives, providing opportunities to network with customers, partners and competitors, educate decision makers, develop and expand markets, and advance relevant technologies.

# WIRELESS GROUPS & ORGANIZATIONS

## CONTINUED

### WiMax Forum

<http://wimaxforum.org>

The WiMAX Forum® is an industry-led, not-for-profit organization that certifies and promotes the compatibility and interoperability of broadband wireless products based upon IEEE Standard 802.16. The WiMAX Forum's primary goal is to accelerate the adoption, deployment, and expansion of WiMAX, AeroMACS, and WiGRID technologies across the globe while facilitating roaming agreements, sharing best practices within our membership and certifying products.

### ZigBee Alliance

<http://www.zigbee.org>

Our innovative standards are custom-designed by industry experts to meet the specific market needs of businesses and consumers. These market leading standards give product manufacturers a straightforward way to help their customers gain greater control of, and even improve, everyday activities.

---

## WIRELESS CONFERENCES 2019 – 2020

### IEEE International Symposium on Personal, Indoor and Mobile Radio Communications

September 8 - 11, 2019

*Istanbul, Turkey*

<http://pimrc2019.ieee-pimrc.org/>

### 2019 IEEE 90th Vehicular Technology Conference

September 22 - 25, 2019

*Honolulu, Hawaii*

<http://www.ieeevtc.org/vtc2019fall/>

### Mobile World Congress 2019

October 22 - 24, 2019

*Las Vegas, Nevada*

<https://www.mwccosangeles.com/>

### Wireless, Telecommunication & IoT

October 23 - 24, 2019

*Rome, Italy*

<https://wirelesscommunication.expertconferences.org/>

### IEEE International Conference on Microwaves, Communications, Antennas and Electronic Systems

November 4 - 6, 2019

*Tel Aviv, Israel*

<http://www.comcas.org>

### MILCOM 2019

November 12 - 14, 2019

*Norfolk, VA*

<http://events.afcea.org/milcom19/public/enter.aspx>

### Consumer Technology Association (CES)

January 7 - 10, 2020

*Las Vegas, Nevada*

<http://www.ces.tech>

### Mobile World Congress

February 24 - 27, 2020

*Barcelona, Spain*

<https://www.mobileworldcongress.com>

### International Conference on Wireless and Optical Communications

March 30 - 31 2020

*Singapore*

<https://10times.com/icwoc>

### International Wireless Communications Expo

March 30 - April 3, 2020

*Las Vegas, Nevada*

<http://www.iwceexpo.com/iwce20/Public/Enter.aspx>

### IEEE Wireless Communications and Networking Conference

April 6 - 9, 2020

*Seoul, South Korea*

<https://wcnc2020.ieee-wcnc.org/>

### Wireless Telecommunications Symposium (IEEE)

April 22 - 24, 2020

*Washington, DC*

<https://www.cpp.edu/~wtsi/>

# WIRELESS CONFERENCES 2019 – 2020

## CONTINUED

### **Internet of Things World**

April 6 - 9, 2020

*San Jose, California*

<https://tmt.knect365.com/iot-world/>

### **IEEE International Conference on Communications**

June 7 - 11, 2020

*Dublin, Ireland*

<http://icc2020.ieee-icc.org>

### **International Symposium on Networks, Computers, and Communications (IEEE)**

June 16 - 18, 2020

*Montreal, Canada*

<http://www.isncc-conf.org>

### **IEEE International Symposium on EMC, Signal and Power Integrity**

July 27 - 31, 2020

*Reno, Nevada*

[https://www.aconf.org/conf\\_146225.html](https://www.aconf.org/conf_146225.html)

### **Association of Public Safety Communications Officials (APCO)**

August 2 - 5, 2020

*Orlando, Florida*

<http://www.apco2020.org>



# WIRELESS TECHNOLOGIES

Dr. Robert Morrow

dr.bob@wireless-seminars.com

Short Range Wireless Technologies					
NAME	PURPOSE	NETWORK TYPE	FREQUENCY BANDS	MODULATION METHOD	WEBSITE
6LoWPAN	IoT using IPv6 addressing	Mesh	<1 GHz and 2.4 GHz ISM	DSSS-PSK	<a href="http://www.datatracker.ietf.org/wg/6lowpan">www.datatracker.ietf.org/wg/6lowpan</a>
Bluetooth	PAN data, multimedia streaming, two-way voice	Point-to-point ad-hoc	2.4 GHz ISM	FHSS-GFSK and FHSS-PSK	<a href="http://www.bluetooth.com">www.bluetooth.com</a>
Insteon	Home automation	Mesh	131.65 kHz (over power line), 900 MHz ISM (RF)	PSK (over power line), FSK (RF)	<a href="http://www.insteon.com">www.insteon.com</a>
IrDA	Short-range optical data	Point-to-point (predominately)	Infrared optical	OOK (predominately)	<a href="http://www.irda.org">www.irda.org</a>
NFC	Very short range data	Point-to-point	13.56 MHz	Backscatter ASK	<a href="http://www.nearfieldcommunication.org">www.nearfieldcommunication.org</a>
RuBee	Product tagging and tracking	Point-to-multipoint	131 kHz inductively coupled	ASK and PSK	<a href="http://www.ru-bee.com">www.ru-bee.com</a>
Wi-Fi	LAN data, multimedia streaming, two-way voice	Point-to-multipoint	2.4 GHz and 5 GHz ISM (predominately)	OFDM	<a href="http://www.wi-fi.org">www.wi-fi.org</a>
ZigBee	Low power control and monitoring	Mesh	2.4 GHz ISM (predominately)	DSSS-PSK	<a href="http://www.zigbee.org">www.zigbee.org</a>
Z-Wave	Home automation	Mesh	900 MHz ISM	GFSK	<a href="http://www.z-wavealliance.org">www.z-wavealliance.org</a>

# USEFUL WIRELESS REFERENCES

## (GROUPS, WEBSITES, BOOKS, FORMULAS & TABLES)

### WIRELESS WORKING GROUPS

#### 802.11 Working Group

The 802.11 Working Group is responsible for developing wireless LAN standards that provide the basis for Wi-Fi.  
<http://grouper.ieee.org/groups/802/11/>

#### 802.15 Working Group

The 802.15 Working Group is responsible for developing wireless PAN standards that provide the basis for Bluetooth and ZigBee.  
<http://www.ieee802.org/15/>

#### 802.16 Working Group

The 802.16 Working Group is responsible for developing wireless MAN standards that provide the basis for WiMAX.  
<http://grouper.ieee.org/groups/802/16/>

#### Bluetooth SIG

The Bluetooth SIG is responsible for developing wireless PAN specifications.  
<https://www.bluetooth.com>

#### Cellular Telecommunications and Internet Association (CTIA)

The CTIA represents cellular, personal communication services, mobile radio, and mobile satellite services over wireless WANs for service providers and manufacturers.  
<http://www.ctia.org>

#### Federal Communications Commission (FCC)

The FCC provides regulatory for RF systems in the U.S.  
<https://www.fcc.gov>

#### GSM Association

The GSM Association participates in the development of development of the GSM platform - holds the annual 3GSM World Congress.  
<http://www.gsmworld.com>

#### Wi-Fi Alliance

The Wi-Fi Alliance develops wireless LAN ("Wi-Fi") specifications based on IEEE 802.11 standards and provides compliance testing of Wi-Fi products.  
<http://www.wi-fi.org>

#### WiMAX Forum

The WiMAX Forum develops wireless MAN standards based on IEEE 802.16 standards and provides compliance testing of WiMAX products.  
<http://wimaxforum.org>

#### ZigBee Alliance

The ZigBee Alliance develops standards for low-power wireless monitoring and control products.  
<http://www.zigbee.org>

### USEFUL WEBSITES

#### ARRL RFI Information

<http://www.arrl.org/radio-frequency-interference-rfi>

#### Jim Brown has several very good articles

**on RFI, including:** A Ham's Guide to RFI, Ferrites, Baluns, and Audio Interfacing.  
[www.audiosystemsgroup.com](http://www.audiosystemsgroup.com)

#### FCC

<http://www.fcc.gov>

#### FCC, Interference with Radio, TV and Telephone Signals

<http://www.fcc.gov/guides/interference-defining-source>

#### IWCE Urgent Communications

<http://urgentcomm.com> has multiple articles on RFI

#### Jackman, Robin, Measure Interference in Crowded Spectrum, Microwaves & RF Magazine, Sept. 2014.

<http://mwr.com/test-measurement-analyzers/measure-interference-crowded-spectrum>

#### RFI Services (Marv Loftness) has some good information on RFI hunting techniques

[www.rfiservices.com](http://www.rfiservices.com)

#### TJ Nelson, Identifying Source of Radio Interference Around the Home, 10/2007

<http://randombio.com/interference.html>

### USEFUL BOOKS

#### *The RFI Book (3rd edition)*

Gruber, Michael  
 ARRL, 2010.

#### *AC Power Interference Handbook (2nd edition)*

Loftness, Marv  
 Percival Publishing, 2001.

#### *Transmitter Hunting: Radio Direction Finding Simplified*

Moell, Joseph and Curlee, Thomas  
 TAB Books, 1987.

# USEFUL WIRELESS REFERENCES

(GROUPS, WEBSITES, BOOKS, FORMULAS & TABLES) CONTINUED

## USEFUL BOOKS CONT.

### **Interference Handbook**

Nelson, William  
Radio Publications, 1981.

### **Electromagnetic Compatibility Engineering**

Ott, Henry W.  
John Wiley & Sons, 2009.

### **Platform Interference in Wireless Systems - Models, Measurement, and Mitigation**

Slattery, Kevin, and Skinner, Harry  
Newnes, 2008.

### **Spectrum and Network Measurements, (2nd Edition)**

Witte, Robert  
SciTech Publishing, 2014.

### **Radio Frequency Interference (RFI) Pocket Guide**

Wyatt and Gruber  
SciTech Publishing, 2015.

## USEFUL FORMULAS AND REFERENCE TABLES

E-Field Levels versus Transmitter Pout			
Pout (W)	V/m at 1m	V/m at 3m	V/m at 10m
1	5.5	1.8	0.6
5	12.3	4.1	1.2
10	17.4	5.8	1.7
25	27.5	9.2	2.8
50	38.9	13.0	3.9
100	55.0	18.3	5.5
1000	173.9	58.0	17.4

Assuming the antenna gain is numerically 1, or isotropic, and the measurement is in the far field and greater than 100 MHz.

### Using Decibels (dB)

The decibel is always a ratio...

- Gain =  $P_{out} / P_{in}$ , where P = power
- Gain(dB) =  $10\log(P_{out} / P_{in})$ , where P = power
- Gain(dB) =  $20\log(V_{out} / V_{in})$ , where V = voltage
- Gain(dB) =  $20\log(I_{out} / I_{in})$ , where I = current

### Power Ratios

3 dB = double (or half) the power

10 dB = 10X (or /10) the power

### Voltage/Current Ratios

6 dB = double (or half) the voltage/current

20 dB = 10X (or /10) the voltage/current

Multiplying power by a factor of 2 corresponds to a 3 dB increase in power. This also corresponds to a 6 dB increase in voltage or current.

Commonly Used Power Ratios (dB)		
Ratio	Power	Voltage or Current
0.1	-10 dB	-20 dB
0.2	-7.0 dB	-14.0 dB
0.3	-5.2 dB	-10.5 dB
0.5	-3.0 dB	-6.0 dB
1	0 dB	0 dB
2	3.0 dB	6.0 dB
3	4.8 dB	9.5 dB
5	7.0 dB	14.0 dB
7	8.5 dB	16.9 dB
8	9.0 dB	18.1 dB
9	9.5 dB	19.1 dB
10	10 dB	20 dB
20	13.0 dB	26.0 dB
30	14.8 dB	29.5 dB
50	17.0 dB	34.0 dB
100	20 dB	40 dB
1,000	30 dB	60 dB
1,000,000	60 dB	120 dB

Multiplying power by a factor of 10 corresponds to a 10 dB increase in power. Multiplying a voltage or current by 10 is a 20 dB increase. Dividing by a factor of 10 corresponds to a 10 dB reduction in power, or 20 dB for voltage and current.

# USEFUL WIRELESS REFERENCES

## (LINKS & WHITEPAPERS)

### COMMON WIRELESS FREQUENCY BANDS (LINKS)

#### GSM Bands:

[https://en.wikipedia.org/wiki/GSM\\_frequency\\_bands](https://en.wikipedia.org/wiki/GSM_frequency_bands)

#### UMTS Bands:

[https://en.wikipedia.org/wiki/UMTS\\_frequency\\_bands](https://en.wikipedia.org/wiki/UMTS_frequency_bands)

#### LTE Bands:

[https://en.wikipedia.org/wiki/LTE\\_frequency\\_bands](https://en.wikipedia.org/wiki/LTE_frequency_bands)

#### MMDS:

[https://en.wikipedia.org/wiki/Multichannel\\_Multipoint\\_Distribution\\_Service](https://en.wikipedia.org/wiki/Multichannel_Multipoint_Distribution_Service)

#### V Band (40 to 75 GHz):

[https://en.wikipedia.org/wiki/V\\_band](https://en.wikipedia.org/wiki/V_band)

#### DECT and DECT 6.0

##### (wireless phones and baby monitors):

[https://en.wikipedia.org/wiki/Digital\\_Enhanced\\_Cordless\\_Telecommunications](https://en.wikipedia.org/wiki/Digital_Enhanced_Cordless_Telecommunications)

#### Comparison of wireless internet standards:

[https://en.wikipedia.org/wiki/Comparison\\_of\\_mobile\\_phone\\_standards](https://en.wikipedia.org/wiki/Comparison_of_mobile_phone_standards)

#### Wi-Fi Protocols (From Intel):

<http://www.intel.com/content/www/us/en/support/network-and-i-o/wireless-networking/000005725.html>

### LINKS TO MANUFACTURER'S WHITE PAPERS

1. VIDEO / Handheld Interference Hunting for Network Operators (Rohde & Schwarz) - [https://www.rohde-schwarz.com/us/solutions/wireless-communications/gsm\\_gprs\\_edge\\_evo\\_vamos/webinars-videos/video-handheld-interference-hunting\\_229255.html](https://www.rohde-schwarz.com/us/solutions/wireless-communications/gsm_gprs_edge_evo_vamos/webinars-videos/video-handheld-interference-hunting_229255.html)
2. Interference Hunting With The R&S FSH (Rohde & Schwarz) - [https://www.rohde-schwarz.com/us/applications/interference-hunting-with-r-s-fsh/application-note\\_56280-77764.html](https://www.rohde-schwarz.com/us/applications/interference-hunting-with-r-s-fsh/application-note_56280-77764.html)
3. Interference Hunting / Part 1 (Tektronix) - <http://www.tek.com/blog/interference-hunting-part-1-4-get-insight-you-need-see-interference-crowded-spectrum>
4. Interference Hunting / Part 2 (Tektronix) - <https://in.tek.com/blog/interference-hunting-part-2-4-how-often-interference-happening>
5. Interference Hunting / Part 3 (Tektronix) - <http://www.tek.com/blog/interference-hunting-part-3-4-use-mask-search-automatically-discover-when-interference-happenin>
6. Interference Hunting / Part 4 (Tektronix) - <https://www.tek.com/blog/interference-hunting-part-4-4-storing-and-sharing-captures-interference-hunter%E2%80%99s-safety-net>





# INDEX OF ADVERTISERS



**Anritsu Company**  
450 Century Parkway, Suite 190  
Allen, TX 75013

**t:** (972) 644-1777  
**e:** sales@anritsu.com  
**w:** www.anritsu.com  
**page:** 5



**EMC Live**  
On-Demand Event

**t:** (484) 688-0300  
**e:** erica@lectrixgroup.com  
**w:** www.emc.live  
**page:** 42



**LECTRIX**  
1000 Germantown Pike  
Plymouth Meeting, PA 19462

**t:** (484) 688-0300  
**w:** www.lectrixgroup.com  
**page:** 43



**Rohde & Schwarz USA, Inc.**  
6821 Benjamin Franklin Drive  
Columbia, MD 21046

**t:** (888) 837-8772  
**w:** www.rohde-schwarz.com  
**page:** 2



**SteppIR Communication Systems**  
13406 SE 32nd Street  
Bellevue, WA 98005

**t:** (425) 453-1910  
**e:** commercial@steppir.com  
**w:** www.steppir.com  
**page:** 8



ONLINE EVENT

# EMCLIVE™

PRESENTED BY INTERFERENCE TECHNOLOGY

Join industry leaders as they share and discuss the latest in EMI/EMC technology. **FREE** practical, important and useful EMC information for electronics engineers, all available On-Demand.

Register for **FREE** to access On-Demand content Now!

[www.EMC.LIVE](http://www.EMC.LIVE)

From the Creators of *Interference Technology*

INTRODUCING



LECTRIX

THERE'S ONLY ONE SPOTLIGHT

ARE YOU IN IT?

Positioning Ambitious B2B Electronics Companies  
for Aggressive Growth

[www.lectrixgroup.com](http://www.lectrixgroup.com)

PHILADELPHIA, PA | HONG KONG