

2019
**EUROPE
EMC GUIDE**

FRANCE
EDITION

it **INTERFERENCE**
TECHNOLOGY®



WHO SAYS YOU CAN'T HAVE IT ALL?

and with next-day, on-time Delivery

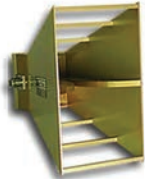

DRG Horns
170 MHz - 40 GHz
4 Models



Log Periodics
80 MHz - 7 GHz
13 Models



Preamplifiers
20 MHz - 40 GHz
9 Models



Low Loss Cables
DC - 40 GHz
3 Models



Biconicals
20 MHz - 18 GHz
7 Models



All in one small package



H-Field Rods
100 Hz - 30 MHz
4 Models



BiLogicals
25 MHz - 7 MHz
8 Models



Probes
20 Hz - 500 MHz
11 Models



Standard Gain Horns
1 GHz - 40 GHz
11 Models



Loops
20 Hz - 30 MHz
6 Models



Tripods and Accessories



Monopoles
100 Hz - 60 MHz
4 Models

Your contact in France:
AR FRANCE
TEL: 33 1 47 91 75 30
FAX: 33 1 47 91 75 35
<http://www.arfrance.eu>
arfcontact@arworld.us

You Can Have It All when it comes to EMC/EMI testing. Our antennas are unique and distinctive with broadband frequency ranges between 20 Hz up to 40 GHz. To view our products and get quick answers to your questions, access our comprehensive online catalog. Search for various information about product descriptions, typical AF plots, VSWR, power handling capabilities and links to product data sheets. Not only have we been developing EMI Antennas for over 40 years, we also have organized worldwide sales representation. You can find your local knowledgeable representative in over 27 countries via our website. For quality products, excellent service and support with

next-day, on-time delivery!

Antennas...

And Kits too.



Innovation

Quality

Performance

Phone: (818)998-0223 ♦ Fax (818)998-6892
<http://www.AHSystems.com>

A.H. Systems



TABLE OF CONTENTS

TABLE OF CONTENTS

2019 Europe EMC Guide

5 | EDITORIAL

- 5 FROM THE EDITOR
Kenneth Wyatt

7 | REFERENCES

- 7 FRANCE COMPANY DIRECTORY
11 PRODUCTS & SERVICES SUPPLIER DIRECTORY
12 EMC EVENTS EUROPE
13 IEEE EMC SOCIETY CHAPTERS IN EUROPE
14 RECOMMENDED DIGITAL GUIDES
16 COMMON EMC STANDARDS
22 EUROPEAN & INTERNATIONAL STANDARDS UPDATE

28 | STANDARDS

- 28 EU FLIGHT EXPERIENCE: BRIEF INTRODUCTION TO
CE MARKING AND EMC EU STANDARDS FOR
ELECTRONIC PRODUCTS
Claudio Stazzone
30 PROPOSED CHANGES TO CISPR SC I STANDARDS
Ghery Pettit

32 | AUTOMOTIVE

- 32 AUTOMOTIVE EMC
Maurizio Di Paolo Emilio

36 | INTERFERENCE

- 36 IDENTIFYING AND LOCATING RADIO FREQUENCY
INTERFERENCE (RFI)
Kenneth Wyatt

41 | EMC TEST

- 41 EMISSIONS TEST FACILITY – OATS VS SAC?
Ghery Pettit
43 WHAT YOU SEE WITH NEAR FIELD PROBES
Arturo Mediano
46 EMI TROUBLESHOOTING WITH REAL-TIME
SPECTRUM ANALYZERS
Kenneth Wyatt

50 | ADVERTISERS INDEX



Chief Executive Officer
Graham Kilshaw

Director of Marketing Operations
Geoffrey Forman

Senior Technical Editor
Kenneth Wyatt

Creative Manager
Christopher Bower

Director of Business Development
Janet Ward

Production Coordinator
Jessica Stewart

Lead Graphic Designer
Kristen Tully

Production Designer
Noah Sneddon

Senior Copywriter
Tom Campbell

Administrative Manager
Eileen M. Ambler

Accounting
Susan Kavetski



USA

1000 Germantown Pike, F-2
Plymouth Meeting, PA 19462
Phone: (484) 688-0300
Fax: (484) 688-0303

E-mail:

info@interferencetechnology.com
www.interferencetechnology.com

CHINA, TAIWAN, HONG KONG

ACT International
Mainland China - Linda Li, +86-21-62511200
Email: lindaL@actintl.com.hk
Hong Kong - Mark Mak, +85-22-8386298
Email: markm@actintl.com.hk

JAPAN

e-OHTAMA, LTD.
Masaki Mori, +81-3-6721-9890
Email: masaki.mori@ex-press.jp

ITEM MEDIA endeavors to offer accurate information, but assumes no liability for errors or omissions. Information published herein is based on the latest information available at the time of publication. Furthermore, the opinions contained herein do not necessarily reflect those of the publisher.

Copyright © 2019 • ITEM Media • ISSN 0190-0943

FREE SUBSCRIPTIONS

ITEM, InterferenceTechnology—The EMC Directory & Design Guide, EMC.Live Guide, Europe EMC Guide are distributed annually at no charge to engineers and managers engaged in the application, selection, design, test, specification or procurement of electronic components, systems, materials, equipment, facilities or related fabrication services. Subscriptions are available through interferencetechnology.com.

A Formidable Force



No one has more experience in all facets of EMC testing equipment than AR Europe and our partners around the world. Working as a team together with our customers, we have the ability to find solutions, solve problems, and provide exceptional service in the most efficient, cost-effective, and timely manner.

With locations throughout Europe, we're nearby and ready to help make EMC testing quicker, easier, and more accurate than ever.

We have developed a very strong customer base in a wide range of electronic/electrical business sectors covering communications, military, commercial, medical, automotive, aerospace, product compliance testing, research and educational markets.

To learn more, visit us at www.ar-europe.ie or call +353 61 504300

In France, contact AR France arfcontact@arworld.us or call +33-1-47-91-75-30

ISO 9001:2015
Certified

Celebrating 50 Years & Still Going Strong





Hi, I hope you enjoy this issue of the 2019 Europe EMC Guide! This year, we're distributing these as free digital downloads, reflecting Interference Technology's continuing direction to provide our readers with timely articles faster using modern digital platforms. This year's issue is the largest ever with eight technical articles. This time, we'll be keeping the content in English, but customizing some of the reference material into nine local countries or regions.

Inside, you'll find several articles discussing EMC measurement, test and design topics. Our lead article is by Claudio Stazzone, EMC Technical Lead at Eurofins EMC Testing in Italy, entitled "Brief Introduction to CE Marking and EMC EU Standards for Electronic Products". He provides a synopsis on how to determine the appropriate standards for a specific product and then describes the three major categories of EMC standards in the EU; Basic, Generic, and Product. He gives examples based on "intended use" to help judge the right standard to be used.

This issue also includes articles on proposed changes to CISPR subcommittee I standards by Ghery Pettit, Automotive EMC, by Di This issue also includes articles on proposed changes to CISPR subcommittee I standards by Ghery Pettit, Automotive EMC, by Di Paolo Emilio, a comparison of outdoor measurement site with semi-anechoic chambers by Ghery Pettit, a description of near field probes by Arturo Mediano. Finally, wrapping up with an article on identifying and locating radio frequency interference - an increasing issue as wireless and mobile devices proliferate - and an article on how to use real-time spectrum analyzers for EMI troubleshooting, by yours truly.

We've also included a recap of important standards news, a list of recent standards, a Products & Services directory for each major country or region, as well as a reference section listing seminars, trade shows, standards working groups, and major EMC standards.

Most of the big changes in the European standards landscape during 2018 was due largely to standards updates for wireless devices. The RED and new medical device standards are now fully required, as well as the new CISPR standards for multimedia systems.

News from Interference Technology- Be sure to check out the many prerecorded presentations from EMC Live 2018 (<https://emc.live>) and the streamed video recordings of selected presentations from the 2018 Symposium on EMC & SIPI (check our web site for the link). These web-based presentations include a number of interesting topics by top names in the industry.

Finally, I wanted to point out all the new FREE downloadable EMC guides we've produced this past year. If you scroll down our home page a bit, you'll see the list of guides. Some of the more popular ones include Military/Aerospace, Automotive, Wireless Interference, EMC Testing, Pre-Compliance testing, and EMC Fundamentals. We also published a compilation of the top-voted articles from the past three years in the "EMC Digest", which is also available as a free download. Check them out here: <http://www.interferencetechnology.com>.

Kenneth Wyatt

Sr. Technical Editor, Interference Technology
kwyatt@interferencetechnology.com



Outstanding perspectives. With EMC solutions from the market leader.

We provide everything you need for development, precompliance and compliance measurements to ensure successful EMC certification.

- ▮ Exceptionally fast EMI test receivers
- ▮ Efficient diagnostic tools for detecting EMI
- ▮ EMC software packages for interactive and fully automatic measurements
- ▮ Wide range of accessories for performing EMI measurements
- ▮ Compact and modular broadband amplifiers
- ▮ RF shielded chambers
- ▮ Complete EMC test systems



ROHDE & SCHWARZ

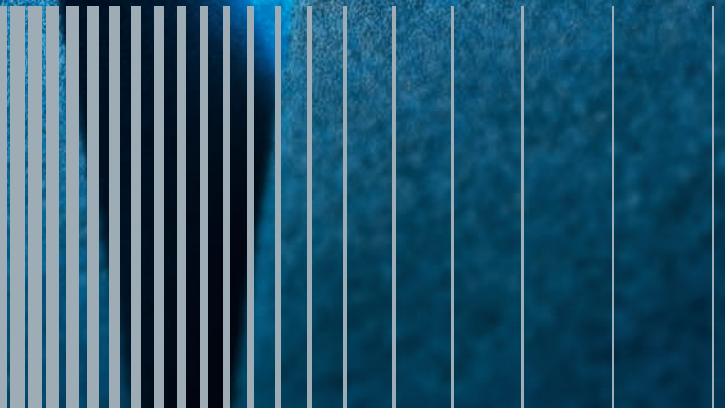

FRANCE

COMPANY DIRECTORY

For any updates to current listed information, please contact: updates@interferencetechnology.com

A

AA Opto-Electronic

AA MCS, 18, rue Nicolas Appert, 91898,
Orsay Cedex, France
Tel: +33 (0)1 76 91 50 12
Fax: +33 (0)1 60 19 42 59
sales@aa-mcs.com
www.aa-mcs.com



AH Systems

AR France
7 Rue des Fosses Blanc Bat D1,
F-92230, Gennevilliers, France
Gennevilliers
Tel: 33 1 47 91 75 30
Fax: 33 1 47 91 75 35
arfcontact@arworld.us
www.ahsystems.com

AMETEK SAS (c/o Teseq)

Rond Point de l'Épine des Champs
Buroplus, Bat D
78990 Elancourt, Frankreich
Tel: +33 1 30 68 89 00
info.france@ametek.com



AR France

7 rue du Fosse Blanc, Bat D1,
Gennevilliers, France 92230
Tel: +33 (0)1 47 91 75 30
arfcontact@arworld.us
www.arfrance.eu

C

Carlisle Interconnect Technologies

Unit 9 Walker Rd., Walker Industrial
Estate, Blackburn, Lancashire BB1 2QE
Tel: +44 (0)1 254 660054
Fax: +44 (0)1 254 660053
www.CarlisleIT.com

CST France Eurl

Immeuble Plaza Carnot, 14 Avenue
Carnot, 91300 Massy, France
Tel: +33 (0)1 60 92 17 51
Fax: +33 (0)1 69 34 28 89
Simulia.cst.fr.hotline@3ds.com
www.cst.com

E

EMC Partner France

Mr Pascal POIRET, 6 rue Clément VI
19300 Rosiers d'Egletons – France
Tel: +33 (0)5 55 74 31 68
Fax: +33 (0)5 55 87 47 69
contact@emc-partner.fr
www.emc-partner.fr

EMI TECH Groupe

3, rue des Coudriers - CAP 78, ZA
de l'Observatoire, 78180 Montigny le
Bretonneux France
Tel: +33 (0)1 30 57 55 55
commercial@emitech.fr
www.emitech.fr

EuroMC

12/24 Avenue de Stalingrad Stains,
ZA St, Leger, 93240, France
Tel: +33 (0)1 58 34 00 00
Fax: +33 (0)1 58 34 07 07
EuroMC@wanadoo.fr
www.euromc.fr

EXXELIA

93, rue Oberkampf, F-75540
PARIS Cedex 11, France
Tel: +33 (0)1 49 23 10 00
Sales.france@exxelia.com
www.exxelia.com



Exodus Advanced Communications

EMC Partner France
Tel : +33-0-5-55-29-3661
ppoiret@emc-partner.fr

F

Fair-Rite Products

Schaffner EMC SAS
112, Quai de Bezons B.P. 133 95103
Argenteuil
Tel: +33 134343060
Fax: +33 139470228
www.schaffner.com/

FCI Connectors

Amphenol ICC, FCI Bensacon SA, 2 Rue
Lafayette, 2500 Bensacon, France
Tel: +33 (0)3 81 54 54 54
Fax : +33 (0)3 81 54 59 38
techsupport@fci.com
www.amphenol-icc.com

G

GETELEC

375 rue Morane Saulnier,
78530 Buc- France
Tel: +33(0)1 39 20 42 42
Fax: +33 (0)1 39 20 43 43
info@getelec.com
www.getelec.com

Gowanda Electronics

ACAL BFI; 4 Allée Du Cantal, ZI La
Petite Montagne Sud, CE 1834 Lisses,
Evry Cedex, France, 91018
Tel: +33 (0)1 60 79 59 00
Fax: +33 (0)1 60 79 89 0
Sales-fr@acalbfi.fr
www.acalbfi.com/fr/

K

Kemtron Sarl

9, Avenue du Bois de l'Épine
Z.A. du Bois de l'Épine
91080 Courcouronnes, France
Tel: +33 (0) 9.67.26.83.16
Fax: +33 (0) 1.60.77.83.16
info@kemtron.fr
www.kemtron.fr

L

COMPANY DIRECTORY

Langer EMV-Technik GmbH

M2S SARL

3 rue des Martins Pêcheurs
F-66700 Argelès sur Mer
Tel. : +33 468-81-4952
Fax: +33 468-81-6216
m2s@wanadoo.fr
www.m2s-argeles.fr

M

M2S

3 Rues Des Martins Pecheurs, 66700
Argeles Sur Mer, France
Tel: +33 (0)4 68 81 49 52
contact@m2s-argeles.fr
www.m2s-argeles.fr

N

Narda Safety Test Solutions S.r.l.

Cobham Microwave / SALIES, Bureau
Villebon
91953 Villebon / Yvette Cedex, France
+33 01 69 59 98 00
info@salies.fr
www.salies.fr

Nexio

48 Rue Rene Sentenac 31300 Toulouse,
France
Tel: +33 (0)5 61 44 02 47
Fax: +33 (0)5 61 44 05 67
www.nexiogroup.com

P

Prana

52 Avenue de la Liberation
CS 10161, 19361 Melemort, Cedex,
France
Tel: +33 (0)5 55 86 49 40
Fax: +33 (0)5 55 86 49 45
ddumont@prana-rd.com
www.prana-rd.com

R



ROHDE & SCHWARZ

Rohde & Schwarz France

Address Parc Tertiaire de Meudon 9 - 11
rue Jeanne Braconnier
92366 Meudon-la-Forêt Cedex, France
Tel: +33 1 41 36 10 06
Fax: +33 1 41 36 10 24
www.rohde-schwarz.com/fr

S

Schlegel Electronic Materials

Yelloz Component - MILMEGA, 4 Rue de
Mayotte Z.I. de Courtaboeuf, FR- 91940
Les Ulis, France
Tel: +33 (0)1 60 92 38 00
www.yellozgroup.com

T

Tech-Etch, Inc.

Yelloz Components
Za de Courtaboeuf, 4 Rue de Mayotte,
F-91940 Les Ulis, France
Tel: +33 (0)1 64 46 69 68
yellozcomponents@yellowzgroup.com
www.tech-etch.com

TDK Electronics France

3 Avenue du Canada, Parc Technopolis-
Batiment Sigma, 91940 Les Ulis, France
Tel: +33 (0)1 60 12 71 65
france@fr.tdk-lambda.com
www.fr.tdk-lambda.com

W



Würth Elektronik eiSos GmbH & Co. KG

Max-Eyth-Str. 1
74638 Waldenburg, Germany
Tel: +49 7942 945 - 0
Fax: +49 7942 945 - 5000
eiSos@we-online.de
www.we-online.com

ASSOCIATIONS

ASSOCIATION FRANÇAISE DE LA COMPATIBILITÉ ELECTROMAGNÉTIQUE

Pour la promotion et le développement de
la Compatibilité ElectroMagnétique
Association régie par la loi du 1er juillet
1901, 86 rue de la Liberté - 38180
SEYSSINS
Tel: +33 (0)1 43 86 13 96
contact@afcem.org
www.afcem.org

IEEE EMC SOCIETY CHAPTER FRANCE

Francois de Daran, Sagem Defence

Securite, 21, Rue du Grand Prieure, 75011
Paris, France

Tel: +33 (0)1 43 34 52 31
Francois.de-daran@sagem.com

NOTIFIED BODIES

AEMC LAB

19 rue François Blumet,
F38360, Sassenage, France
Tel: +33 (0)4 76 27 83 83
Fax: +33 (0)4 76 27 77 00
aemc.lab@wanadoo.fr

ASEFA

33 avenue du Général Leclerc
92260 Fontenay-aux-Roses, France
Head of ASEFA - Vincent Schuhl
Tel: +33 (0)1 40 95 60 70
Vincent.schuhl@asefa-cert.com

ASEFA - PLATE FORME F 03 - SCHNEIDER ELECTRIC INDUSTRIES

37 quai Paul Louis Merlin,
38050 Grenoble cedex 9, France
Tel: +33 (0)4 76 39 85 51
Fax: +33 (0)4 76 57 99 38
william.magnon@schneider-electric.com
www.schneider-electric.com

ASEFA - PLATE FORME P 01 -LEGRAND

128 avenue du Maréchal de Lattre de
Tassigny, F87045 Limoges cedex, France
Tel: +33 (0)5 55 06 87 87
Fax: +33 (0)5 55 06 88 88
didier.leblanc@legrand.fr

ASEFA - PLATE FORME V 01 - ALSTOM TRANSPORT

11-13 Avenue de Bel Air 69627
Villurbanne Cedex, France
Tel: +33 (0)4 72 81 46 27
carlos-queiros-de-oliveira@transport.
alstom.com
www.alstom.transport.com

CENTRE TECHNIQUE DES INDUSTRIES MECANIQUES

52 Avenue Felix Louat - CS 80067, F60304
Senlis Cedex,
Tel: +33 (0)3 44 67 36 82
Fax: +33 (0)3 44 67 36 94
www.cetim.fr

EMITECH ATLANTIQUE

Rue de la Claie 15,
ZI Angers-Beaucouzé, 49070
Beaucouze, France

COMPANY DIRECTORY

Tel: +33 (0)2 41 73 26 27
www.emitech.fr

EMITECH - CHASSIEU

7, rue Georges Méliès, F
69680 Chassieu, France
Tel: +33 (0)4 78 40 66 55
Fax: +33 (0)4 72 47 00 39
chassieu@emitech.fr
www.emitech.fr

EMITECH GRAND SUD

Rue du Massacan 145, ZI Vallée du
Salaison, BP80025, 34741 Vendargues
Cedex, France
Tel: +33 (0)4 67 87 11 02
Fax: +33 (0)4 67 70 94 55
grand-sud@emitech.fr
www.emitech.fr

EMITECH ILE DE FRANCE

Z.A. de l'Observatoire 3 rue des
Coudriers, 78180 Montigny Le
Bretonneux, France
Tel: +33 (0)1 30 57 55 55
contact@emitech.fr
www.emitech.fr

EMITECH - LE RHEU

2 allée du Chêne Vert F35650 Le Rheu, Le
Rheu, France
Tel: +33 (0)2 99 14 59 14
lerheu@emitech.fr
www.emitech.fr

EUROCEM

364, rue Armand Japy Technoland, 25460
Etupes, Cedex, France
Tel: +33 (0)3 81 90 75 90
commercial@eurocem.fr
www.eurocem.fr

GYL TECHNOLOGIES

Parc d'activités de Lanserre 21 rue de la
Fuye F49610 Juigne sur Loire, Juigne sur
loire, France
Tel: +33 (0)2 41 57 57 40

GROUPE D'ETUDES ET DE RECHERCHES APPLIQUÉES À LA COMPATIBILITÉ

Parc Activities Laseris, 1 Avenue du
Medoc, 33114 Le Barp, France
Tel: +33 (0)8 90 10 93

INSTITUT NATIONAL DE L'ENVIRONNEMENT INDUSTRIEL ET DES RISQUES

Parc Technologique Alata BP 2, F60550
Verneuil-en-Halatte, France
Tel: +33 (0)3 44 55 66 77
Fax: +33 (0)3 44 55 66 99
www.ineris.fr

LABORATOIRE CENTRAL DES INDUSTRIES ELECTRIQUES

33 avenue du Général Leclerc, F92266
Fontenay-aux-Roses cedex, France
Tel: +33 (0)1 40 95 60 60
Fax: +33 (0)1 40 95 86 56
www.lcie.fr

LABORATOIRE NATIONAL DE MÉTROLOGIE ET D'ESSAIS

1, rue Gaston Boissier, 75724 PARIS
CEDEX 15, France
Tel: +33 (0)1 40 43 37 00
Fax: +33 (0)1 40 43 37 37
www.lne.fr

LABORATOIRE CENTRAL DES INDUSTRIES ELECTRIQUES - ETABLISSEMENT SUD-EST

ZI Centr'Alp 170 rue de Chatagnon
F38430 Moirans, France
Tel: +33 (0)4 76 07 36 36
Fax: +33 (0)4 76 55 90 88
www.lcie.fr

UNION TECHNIQUE DE L'AUTOMOBILE

Autodrome de Linas-Montlhéry BP 20212
91311 Montlhéry Cedex, France
Tel: +33 (0)1 69 80 17 00
Fax: +33 (0)1 69 80 17 17
www.utac.com

OTHER

MINISTÈRE DE L'ECONOMIE, DES FINANCES ET DE L'INDUSTRIE DIGITIP/ SPIC/SQUALPI DIGITIP 5

Teledoc 151, 139, Rue de Bercy, 75572
Paris Cedex, France
Tel: +33 (0)1 40 04 04 04



STATE-OF-THE-ART

18.0-26.5 GHz
26.5-40.0 GHz
High Power
Solid State Modules

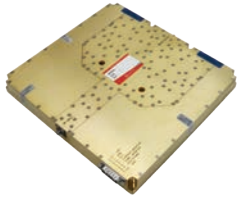

AMP3029
18.0-26.5 GHz
10 Watt Min



AMP3132
26.5-40.0 GHz
8 Watt Min

BROADBAND HIGH POWER

0.7-6.0 GHz, 100 Watt
6.0-18.0 GHz, 100 Watt



AMP1044B

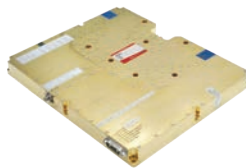

AMP1122BH

Hybrid GaAs/GaN designs for superior linearity & P1dB

SUPER PULSE

1.0-2.0 GHz, 1.0-2.5 GHz,
2.0-4.0 GHz, 4.0-8.0 GHz,
1.2-1.4 GHz, 2.7-3.5 GHz



Power Levels to 10KW

Other frequency ranges & power levels available

NEW!

**EXODUS 2.0 MHz-40.0 GHz
Solid State Rack Solution up to 200 V/m**



Exodus Advanced Communications producing the highest quality products with the latest technologies & innovations for modules & systems up to 51 GHz!

EXIT OUT OF THE ORDINARY



Exodus Advanced Communications

3674 E. Sunset Road, Suite 100

Las Vegas, Nevada 89120 USA

Tel : 1-702-534-6564

Fax : 1-702-441-7016

Email : EUSales@exoduscomm.com

Local Contact



EMC Partner France

ppoiret@emc-partner.fr

Tel : +33-0-5-55-29-3661

FRANCE

PRODUCTS AND SERVICES DIRECTORY

Please See Company Directory for Company Contact Information on Page 7

For any updates to current listed information, please contact: updates@interferencetechnology.com

Amplifiers

AA Opto-Electronic
 A.H. Systems, Inc.
 AMETEK CTS Europe GmbH
 AR RF/Microwave Instrumentation
 Exodus Advanced Communications
 Narda Safety Test Solutions GmbH
 Rohde & Schwarz GmbH & Co. KG
 Prana

Antennas

A.H. Systems, Inc.
 AMETEK CTS Europe GmbH
 AR RF/Microwave Instrumentation
 Exodus Advanced Communications
 Narda Safety Test Solutions GmbH
 Rohde & Schwarz GmbH & Co. KG

Chambers

CST France Eurl

Filters

AA Opto-Electronic
 Carlisle Interconnect Technologies
 EuroMC
 EXXELIA
 Fair-Rite Products
 FCI Connectors
 Gowanda Electronics
 TDK Electronics France
 Würth Elektronik eiSos GmbH & Co. KG

Shielding

AR RF/Microwave Instrumentation
 Carlisle Interconnect Technologies

GETELEC

Kemtron Sarl
 Schlegel Electronic Materials
 Tech-Etch, Inc.
 Würth Elektronik eiSos GmbH & Co. KG

Spectrum Analyzers

AR RF/Microwave Instrumentation
 Rohde & Schwarz GmbH & Co. KG

Test Instrumentation

A.H. Systems, Inc.
 AMETEK CTS Europe GmbH
 AR RF/Microwave Instrumentation
 Exodus Advanced Communications
 Langer EMV-Technik GmbH
 Rohde & Schwarz GmbH & Co. KG
 M2S
 Nexio

Testing

EMI TECH Groupe

ASSOCIATIONS

ASSOCIATION FRANÇAISE DE LA
 COMPATIBILITÉ
 ELECTROMAGNÉTIQUE
 IEEE EMC SOCIETY CHAPTER
 FRANCE

NOTIFIED BODIES

AEMC LAB
 ASEFA
 ASEFA - PLATE FORME F
 03 - SCHNEIDER ELECTRIC

INDUSTRIES

ASEFA - PLATE FORME P 01 -LEGRAND
 ASEFA - PLATE FORME V 01
 - ALSTOM TRANSPORT
 CENTRE TECHNIQUE DES
 INDUSTRIES MECANIQUES
 EMITECH ATLANTIQUE
 EMITECH - CHASSIEU
 EMITECH GRAND SUD
 EMITECH ILE DE FRANCE
 EMITECH - LE RHEU
 EUROCEM
 GYL TECHNOLOGIES
 GROUPE D'ETUDES ET
 DE RECHERCHES APPLIQUÉES À LA
 COMPATIBILITÉ
 INSTITUT NATIONAL DE
 L'ENVIRONNEMENT INDUSTRIEL
 ET DES RISQUES
 LABORATOIRE CENTRAL
 DES INDUSTRIES ELECTRIQUES
 LABORATOIRE NATIONAL
 DE MÉTROLOGIE ET D'ESSAIS
 LABORATOIRE CENTRAL
 DES INDUSTRIES ELECTRIQUES
 - ETABLISSEMENT SUD-EST
 UNION TECHNIQUE DE
 L'AUTOMOBILE

OTHER

MINISTÈRE DE L'ECONOMIE, DES
 FINANCES ET DE L'INDUSTRIE
 DIGITIP/ SPIC/SQUALPI DIGITIP 5

EMC EVENTS

EUROPE

EUROPEAN EMC (AND RELATED) CONFERENCES

EEV CONVENTIONS

Various Dates 2019

Various Locations

<http://www.eevc.eu>

The EEV Congress has changed to the EEV Conventions, including Infrastructure, Policies, Safety & Regulations, Electric Bus & Trucks, and Energy Storage & Management. Check the link for details.

APPLIED POWER ELECTRONICS (APEC)

March 17-21, 2019

Anaheim, California

<http://www.apec-conf.org>

APEC focuses on the practical and applied aspects of the power electronics business. This is not just a designer's conference; APEC has something of interest for anyone involved in power electronics.

EMV INTERNATIONAL EXHIBITION

March 19-21, 2019

Stuttgart, Germany

<https://emv.mesago.com/events/en.html>

MICROWAVE AND RF EXPO

March 20-21, 2019

Paris, France

<http://www.microwave-rf.com>

EXPO ELECTRONICA

April 15-17, 2019

Moscow, Russia

<http://www.expoelectronica.ru>

THE BATTERY SHOW - EUROPE

May 7-9, 2019

Stuttgart, Germany

<http://www.thebatteryshow.eu>

The Battery Show Europe Exhibition & Conference is a showcase of advanced battery manufacturing and technology for electric & hybrid vehicles, utility & renewable energy support, portable electronics, medical technology, military and telecommunications.

AUTOMOTIVE TESTING EXPO (INCLUDES EMC)

May 21-23, 2019

Stuttgart, Germany

<http://www.testing-expo.com/europe/english/>

This conference includes the very latest technologies and services that are designed to ensure that the highest standards are met in terms of product quality, reliability, durability and safety.

GLOBAL AUTOMOTIVE COMPONENTS AND SUPPLIERS

May 21-23, 2019

Stuttgart, Germany

www.globalautomotivecomponentsandsuppliersexpo.com/en/

Automotive Component Manufacturers from around the world will be at the expo to display their very latest technologies and products, plus numerous more exhibitors will be on hand to discuss how they can participate in cost reduction within supply chains, and how they can offer new, alternative, cost-effective manufacturing and supply solutions.

AUTOMOBIL ELEKTRONIK KONGRESS

June 25-26, 2019

Ludwigsburg, Germany

<https://www.automobil-elektronik-kongress.de/en/>

The European Electric & Hybrid Vehicle Congress is a global platform to foster exchange of views between the R&D, the industry, the authorities, and end users to develop synergies in the field of e-mobility.

EMC EUROPE 2019

September 2-6, 2019

Amsterdam, The Netherlands

<http://www.emceurope2018.org>

ELECTRIC & HYBRID VEHICLE TECHNOLOGY SHOW

September 10-12, 2019

Novi, Michigan

<http://www.evtechexpo.com>

Electric & Hybrid Vehicle Technology Expo is the premier showcase for electric and hybrid vehicle technology and innovation. The show highlights advances right across the powertrain and across a wide range of vehicles from passenger and commercial to off-highway industrial vehicles.

IEEE EMC SOCIETY CHAPTERS IN EUROPE

BENELUX

Frank Leferink
Hengelo, GD
The Netherlands
Phone: +31 74-248-3132
Website: <http://www.emc-esd.nl>

CROATIA

Vicko Doric
Split, Croatia
Website: http://www.ieee.hr/ieeesection/odjeli_chapteri/emc27

FRANCE

François de Daran
Paris, France
Website: <https://www.ieee-france.org/>

GERMANY

Christian Schuster
Hamburg, Germany
Phone: +49 40 42878 3116
Website: <http://www.ewh.ieee.org/r8/germany/emc/>

HUNGARY JT. CHAPTER, AP03/ED15/MTT17/COM19/EMC27

Lajos Nagy
Budapest, Hungary
Phone: 36 1-463-1559
Website: http://hvt.bme.hu/index.php?option=com_content&view=article&id=523&Itemid=33&lang=hu

ITALY

Luigi Caputo
TO, Italy
Phone: +39 348-2903097
Website: <http://ing.univaq.it/emc-chap-it/>

POLAND

Grzegorz Maslowski
Rzeszów, Poland
Phone: +48 17-865-1253
Website: <http://www.emc27-ieee-pl.neostrada.pl>

ROMANIA

Mihaela Morega
Romania
Website: www.acero.ro/ct-chapter.htm

RUSSIA (NORTHWEST)

Joint: IE13/EMC27/PE31
Irina Kruchinina
Russia

RUSSIA (SIBERIA)

Joint: AP/ED/MTT/COM/EMC27
Dmitry Zykov
Russia
Website: <http://chapters.comsoc.org/tomsk>

SERBIA AND MONTENEGRO

Vesna Javor
18000 Nis, Serbia and Montenegro
Phone: 381-18-529-447
Website: <http://www.ieee.uns.ac.rs/ieee-emc.htm>

SPAIN

Fernando Silva Martinez
Bacelona, Spain
Phone: +34 934017826

SWEDEN

Christer Karlsson
Sweden
Website: <http://www.ieee.se/>

SWITZERLAND SECTION JT.

Joint: AP03/MTT17/EMC27
Nicolas Mora
Website: <https://www.ieee.ch/chapters/ap-mtt-emc>

TURKEY SECTION

Joint: AP/ED/MTT/EMC
Ozgur Ergul
Turkey
Website: <http://sites.ieee.org/turkey/>

UK AND IRELAND

Roy Ediss
Totton, Hampshire, UK and Ireland
Website: <http://www.ieee-ukandireland.org/chapters/electromagnetic-compatibility/>

UKRAINE

Joint: SP/AP/C/EMC/COM
Marya Antyufeyeva
Ukraine
Website: <http://www-ieee.univer.kharkov.ua/>

RECOMMENDED DIGITAL GUIDES

FROM INTERFERENCE TECHNOLOGY (FREE DOWNLOADS)

www.interferencetechnology.com/digital-publications/#



2018 AUTOMOTIVE EMC GUIDE

Includes articles and reference information related to automotive EMC.

► [Download Here](#)



2018 MILITARY & AEROSPACE EMC GUIDE

Includes articles and reference information related to military and aerospace EMC test and product design.

► [Download Here](#)



2018 COMPONENTS & MATERIALS GUIDE

Includes articles and reference information related to EMC components and materials.

► [Download Here](#)



2017 EMC PRE-COMPLIANCE TEST GUIDE

Includes articles and reference information related to performing your own EMC/EMI pre-compliance testing in-house, saving valuable time having to troubleshoot at the compliance test facility.

► [Download Here](#)



2018 EMC TESTING GUIDE

Includes articles and reference information related to EMC/EMI testing and how these tests are performed.

► [Download Here](#)



2017 MEDICAL EMC GUIDE

Includes articles and reference information related to medical EMC product design and test.

► [Download Here](#)



2018 EMC FUNDAMENTALS GUIDE

Includes articles and reference information related to fundamental EMC product design concepts.

► [Download Here](#)



2017 WIRELESS INTERFERENCE & RFI GUIDE

This new guide includes articles and reference information related to wireless and radio frequency interference.

► [Download Here](#)

crystal clear frequencies.

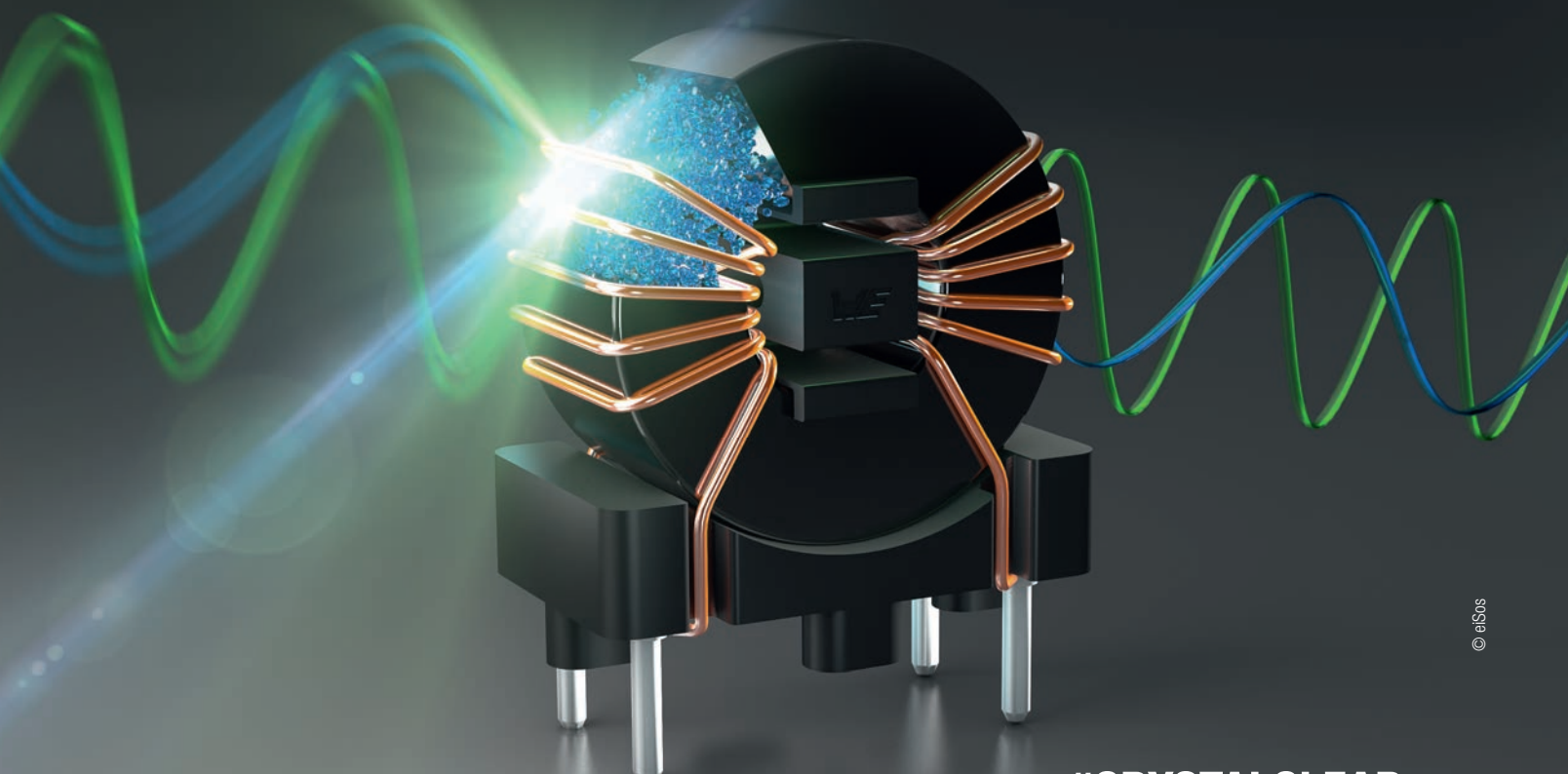

© elSOS



#CRYSTALCLEAR

*WE speed up
the future*

The WE-CMBNC is a VDE certified series of common mode chokes with a highly permeable **nanocrystalline core material**. Despite the small size, it delivers outstanding broadband attenuation performance, high rated currents and low DC resistance values. Low profile and high voltage ratings can also be realized by the common mode chokes of the WE-CMB family.

For further information, please visit:
www.we-online.com/we-cmb

- High permeability nanocrystalline core material
- High I_R & low R_{DC} in a small size
- Broadband suppression
- Stable inductance values at high temperatures
- Improved isolation through plastic case and patented winding spacer

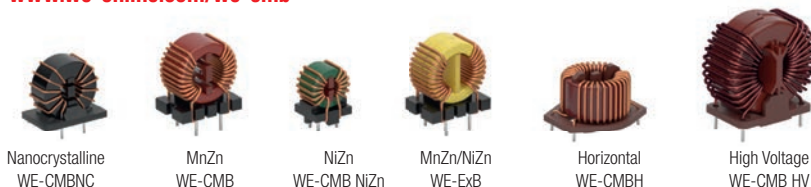

COMMON EMC STANDARDS

COMMERCIAL ELECTROMAGNETIC COMPATIBILITY (EMC) STANDARDS

Reference:

http://www.cvel.clemson.edu/emc/tutorials/commercial_emc_standards.html

Permission to republish granted

ANSI	
Document Number	Title
C63.4	Methods of Measurement of Radio-Noise Emissions from Low-Voltage Electrical and Electronic Equipment in the Range of 9 kHz to 40 GHz

IEC	
Document Number	Title
IEC 60050-161	International Electrotechnical Vocabulary. Chapter 161: Electromagnetic compatibility
IEC 60060-1	High-voltage test techniques. Part 1: General definitions and test requirements
IEC 60060-2	High-voltage test techniques - Part 2: Measuring systems
IEC 60060-3	High-voltage test techniques - Part 3: Definitions and requirements for on-site testing
IEC 60118-13	Electroacoustics - Hearing aids - Part 13: Electromagnetic compatibility (EMC)
IEC 60255-26	Measuring relays and protection equipment - Part 26: Electromagnetic compatibility requirements
IEC 60364-4-44	Low-voltage electrical installations - Part 4-44: Protection for safety - Protection against voltage disturbances and electromagnetic disturbance
IEC 60469	Transitions, pulses and related waveforms - Terms, definitions and algorithms
IEC 60533	Electrical and electronic installations in ships - Electromagnetic compatibility (EMC) - Ships with a metallic hull
IEC 60601-1-2	Medical electrical equipment - Part 1-2: General requirements for basic safety and essential performance - Collateral Standard: Electromagnetic disturbances - Requirements and tests
IEC 60601-2-2	Medical electrical equipment - Part 2-2: Particular requirements for the basic safety and essential performance of high frequency surgical equipment and high frequency surgical accessories
IEC 60601-4-2	Medical electrical equipment - Part 4-2: Guidance and interpretation - Electromagnetic immunity: performance of medical electrical equipment and medical electrical systems
IEC 60728-2	Cabled distribution systems for television and sound signals - Part 2: Electromagnetic compatibility for equipment
IEC 60728-12	Cabled distribution systems for television and sound signals - Part 12: Electromagnetic compatibility of systems

IEC (continued)	
Document Number	Title
IEC/TS 60816	Guide on methods of measurement of short duration transients on low-voltage power and signal lines
IEC 60870-2-1	Telecontrol equipment and systems - Part 2: Operating conditions - Section 1: Power supply and electromagnetic compatibility
IEC 60940	Guidance information on the application of capacitors, resistors, inductors and complete filter units for electromagnetic interference suppression
IEC 60974-10	Arc welding equipment - Part 10: Electromagnetic compatibility (EMC) requirements
IEC/TR 61000-1-1	Electromagnetic compatibility (EMC) - Part 1: General - Section 1: Application and interpretation of fundamental definitions and terms
IEC/TS 61000-1-2	Electromagnetic compatibility (EMC) - Part 1-2: General - Methodology for the achievement of the functional safety of electrical and electronic equipment with regard to electromagnetic phenomena
IEC/TR 61000-1-3	Electromagnetic compatibility (EMC) - Part 1-3: General - The effects of high-altitude EMP (HEMP) on civil equipment and systems
IEC/TR 61000-1-4	Electromagnetic compatibility (EMC) - Part 1-4: General - Historical rationale for the limitation of power-frequency conducted harmonic current emissions from equipment, in the frequency range up to 2 kHz
IEC/TR 61000-1-5	Electromagnetic compatibility (EMC) - Part 1-5: General - High power electromagnetic (HPEM) effects on civil systems
IEC/TR 61000-1-6	Electromagnetic compatibility (EMC) - Part 1-6: General - Guide to the assessment of measurement uncertainty
IEC/TR 61000-1-7	Electromagnetic compatibility (EMC) - Part 1-7: General - Power factor in single-phase systems under non-sinusoidal conditions
IEC/TR 61000-2-1	Electromagnetic compatibility (EMC) - Part 2: Environment - Section 1: Description of the environment - Electromagnetic environment for low-frequency conducted disturbances and signaling in public power supply systems
IEC 61000-2-2	Electromagnetic compatibility (EMC) - Part 2-2: Environment - Compatibility levels for low-frequency conducted disturbances and signaling in public low-voltage power supply systems
IEC/TR 61000-2-3	Electromagnetic compatibility (EMC) - Part 2: Environment - Section 3: Description of the environment - Radiated and non-network-frequency-related conducted phenomena

IEC (continued)	
Document Number	Title
IEC 61000-2-4	Electromagnetic compatibility (EMC) - Part 2-4: Environment - Compatibility levels in industrial plants for low-frequency conducted disturbances
IEC/TS 61000-2-5	Electromagnetic compatibility (EMC) - Part 2: Environment - Section 5: Classification of electromagnetic environments. Basic EMC publication
IEC/TR 61000-2-6	Electromagnetic compatibility (EMC) - Part 2: Environment - Section 6: Assessment of the emission levels in the power supply of industrial plants as regards low-frequency conducted disturbances
IEC/TR 61000-2-7	Electromagnetic compatibility (EMC) - Part 2: Environment - Section 7: Low frequency magnetic fields in various environments
IEC/TR 61000-2-8	Electromagnetic compatibility (EMC) - Part 2-8: Environment - Voltage dips and short interruptions on public electric power supply systems with statistical measurement results
IEC 61000-2-9	Electromagnetic compatibility (EMC) - Part 2: Environment - Section 9: Description of HEMP environment - Radiated disturbance. Basic EMC publication
IEC 61000-2-10	Electromagnetic compatibility (EMC) - Part 2-10: Environment - Description of HEMP environment - Conducted disturbance
IEC 61000-2-11	Electromagnetic compatibility (EMC) - Part 2-11: Environment - Classification of HEMP environments
IEC 61000-2-12	Electromagnetic compatibility (EMC) - Part 2-12: Environment - Compatibility levels for low-frequency conducted disturbances and signaling in public medium-voltage power supply systems
IEC 61000-2-13	Electromagnetic compatibility (EMC) - Part 2-13: Environment - High-power electromagnetic (HPEM) environments - Radiated and conducted
IEC/TR 61000-2-14	Electromagnetic compatibility (EMC) - Part 2-14: Environment - Overvoltages on public electricity distribution networks
IEC 61000-3-2	Electromagnetic compatibility (EMC) - Part 3-2: Limits - Limits for harmonic current emissions (equipment input current ≤ 16 A per phase)
IEC 61000-3-3	Electromagnetic compatibility (EMC) - Part 3-3: Limits - Limitation of voltage changes, voltage fluctuations and flicker in public low-voltage supply systems, for equipment with rated current ≤ 16 A per phase and not subject to conditional connection
IEC/TS 61000-3-4	Electromagnetic compatibility (EMC) - Part 3-4: Limits - Limitation of emission of harmonic currents in low-voltage power supply systems for equipment with rated current greater than 16 A
IEC/TS 61000-3-5	Electromagnetic compatibility (EMC) - Part 3: Limits - Section 5: Limitation of voltage fluctuations and flicker in low-voltage power supply systems for equipment with rated current greater than 16 A
IEC/TR 61000-3-6	Electromagnetic compatibility (EMC) - Part 3: Limits - Section 6: Assessment of emission limits for distorting loads in MV and HV power systems - Basic EMC publication
IEC/TR 61000-3-7	Electromagnetic compatibility (EMC) - Part 3: Limits - Section 7: Assessment of emission limits for fluctuating loads in MV and HV power systems - Basic EMC publication
IEC 61000-3-8	Electromagnetic compatibility (EMC) - Part 3: Limits - Section 8: Signaling on low-voltage electrical installations - Emission levels, frequency bands and electromagnetic disturbance levels
IEC 61000-3-11	Electromagnetic compatibility (EMC) - Part 3-11: Limits - Limitation of voltage changes, voltage fluctuations and flicker in public low-voltage supply systems - Equipment with rated current ≤ 75 A and subject to conditional connection

IEC (continued)	
Document Number	Title
IEC 61000-3-12	Electromagnetic compatibility (EMC) - Part 3-12: Limits - Limits for harmonic currents produced by equipment connected to public low-voltage systems with input current >16 A and ≤ 75 A per phase
IEC/TR 61000-3-13	Electromagnetic compatibility (EMC) - Part 3-13: Limits - Assessment of emission limits for the connection of unbalanced installations to MV, HV and EHV power systems
IEC/TR 61000-3-14	Electromagnetic compatibility (EMC) - Part 3-14: Assessment of emission limits for harmonics, interharmonics, voltage fluctuations and unbalance for the connection of disturbing installations to LV power systems
IEC/TR 61000-3-15	Electromagnetic compatibility (EMC) - Part 3-15: Limits - Assessment of low frequency electromagnetic immunity and emission requirements for dispersed generation systems in LV network
IEC TR 61000-4-1	Electromagnetic compatibility (EMC) - Part 4-1: Testing and measurement techniques - Overview of IEC 61000-4 series
IEC 61000-4-2	Electromagnetic compatibility (EMC) - Part 4-2: Testing and measurement techniques - Electrostatic discharge immunity test
IEC 61000-4-3	Electromagnetic compatibility (EMC) - Part 4-3 : Testing and measurement techniques - Radiated, radio-frequency, electromagnetic field immunity test
IEC 61000-4-4	Electromagnetic compatibility (EMC) - Part 4-4 : Testing and measurement techniques - Electrical fast transient/burst immunity test
IEC 61000-4-5	Electromagnetic compatibility (EMC) - Part 4-5: Testing and measurement techniques - Surge immunity test
IEC 61000-4-6	Electromagnetic compatibility (EMC) - Part 4-6: Testing and measurement techniques - Immunity to conducted disturbances, induced by radio-frequency fields
IEC 61000-4-7	Electromagnetic compatibility (EMC) - Part 4-7: Testing and measurement techniques - General guide on harmonics and interharmonics measurements and instrumentation, for power supply systems and equipment connected thereto
IEC 61000-4-8	Electromagnetic compatibility (EMC) - Part 4-8: Testing and measurement techniques - Power frequency magnetic field immunity test
IEC 61000-4-9	Electromagnetic compatibility (EMC) - Part 4-9: Testing and measurement techniques - Impulse magnetic field immunity test
IEC 61000-4-10	Electromagnetic compatibility (EMC) - Part 4-10: Testing and measurement techniques - Damped oscillatory magnetic field immunity test
IEC 61000-4-11	Electromagnetic compatibility (EMC) - Part 4-11: Testing and measurement techniques - Voltage dips, short interruptions and voltage variations immunity tests
IEC 61000-4-12	Electromagnetic compatibility (EMC) - Part 4-12: Testing and measurement techniques - Ring wave immunity test
IEC 61000-4-13	Electromagnetic compatibility (EMC) - Part 4-13: Testing and measurement techniques - Harmonics and interharmonics including mains signaling at a.c. power port, low frequency immunity tests
IEC 61000-4-14	Electromagnetic compatibility (EMC) - Part 4-14: Testing and measurement techniques - Voltage fluctuation immunity test
IEC 61000-4-15	Electromagnetic compatibility (EMC) - Part 4: Testing and measurement techniques - Section 15: Flickermeter - Functional and design specifications
IEC 61000-4-16	Electromagnetic compatibility (EMC) - Part 4-16: Testing and measurement techniques - Test for immunity to conducted, common mode disturbances in the frequency range 0 Hz to 150 kHz

IEC (continued)	
Document Number	Title
IEC 61000-4-17	Electromagnetic compatibility (EMC) - Part 4-17: Testing and measurement techniques - Ripple on d.c. input power port immunity test
IEC 61000-4-18	Electromagnetic compatibility (EMC) - Part 4-18: Testing and measurement techniques - Damped oscillatory wave immunity test
IEC 61000-4-19	Electromagnetic compatibility (EMC) - Part 4-19: Testing and measurement techniques - Test for immunity to conducted, differential mode disturbances and signalling in the frequency range 2 kHz to 150 kHz at a.c. power ports
IEC 61000-4-20	Electromagnetic compatibility (EMC) - Part 4-20: Testing and measurement techniques - Emission and immunity testing in transverse electromagnetic (TEM) waveguides
IEC 61000-4-21	Electromagnetic compatibility (EMC) - Part 4-21: Testing and measurement techniques - Reverberation chamber test methods
IEC 61000-4-22	Electromagnetic compatibility (EMC) - Part 4-22: Testing and measurement techniques - Radiated emissions and immunity measurements in fully anechoic rooms (FARs)
IEC 61000-4-23	Electromagnetic compatibility (EMC) - Part 4-23: Testing and measurement techniques - Test methods for protective devices for HEMP and other radiated disturbances
IEC 61000-4-24	Electromagnetic compatibility (EMC) - Part 4-24: Testing and measurement techniques - Test methods for protective devices for HEMP conducted disturbance
IEC 61000-4-25	Electromagnetic compatibility (EMC) - Part 4-25: Testing and measurement techniques - HEMP immunity test methods for equipment and systems
IEC 61000-4-27	Electromagnetic compatibility (EMC) - Part 4-27: Testing and measurement techniques - Unbalance, immunity test
IEC 61000-4-28	Electromagnetic compatibility (EMC) - Part 4-28: Testing and measurement techniques - Variation of power frequency, immunity test
IEC 61000-4-29	Electromagnetic compatibility (EMC) - Part 4-29: Testing and measurement techniques - Voltage dips, short interruptions and voltage variations on d.c. input power port immunity tests
IEC 61000-4-30	Electromagnetic compatibility (EMC) - Part 4-30: Testing and measurement techniques - Power quality measurement methods
IEC 61000-4-31	Electromagnetic compatibility (EMC) - Part 4-31: Testing and measurement techniques - AC mains ports broadband conducted disturbance immunity test
IEC/TR 61000-4-32	Electromagnetic compatibility (EMC) - Part 4-32: Testing and measurement techniques - High-altitude electromagnetic pulse (HEMP) simulator compendium
IEC 61000-4-33	Electromagnetic compatibility (EMC) - Part 4-33: Testing and measurement techniques - Measurement methods for high-power transient parameters
IEC 61000-4-34	Electromagnetic compatibility (EMC) - Part 4-34: Testing and measurement techniques - Voltage dips, short interruptions and voltage variations immunity tests for equipment with input current more than 16 A per phase
IEC TR 61000-4-35	Electromagnetic compatibility (EMC) - Part 4-35: Testing and measurement techniques - HPEM simulator compendium
IEC 61000-4-36	Electromagnetic compatibility (EMC) - Part 4-36: Testing and measurement techniques - IEMI immunity test methods for equipment and systems
IEC TR 61000-4-37	Electromagnetic compatibility (EMC) - Calibration and verification protocol for harmonic emission compliance test systems
IEC TR 61000-4-38	Electromagnetic compatibility (EMC) - Part 4-38: Testing and measurement techniques - Test, verification and calibration protocol for voltage fluctuation and flicker compliance test systems

IEC (continued)	
Document Number	Title
IEC/TR 61000-5-1	Electromagnetic compatibility (EMC) - Part 5: Installation and mitigation guidelines - Section 1: General considerations - Basic EMC publication
IEC/TR 61000-5-2	Electromagnetic compatibility (EMC) - Part 5: Installation and mitigation guidelines - Section 2: Earthing and cabling
IEC/TR 61000-5-3	Electromagnetic compatibility (EMC) - Part 5-3: Installation and mitigation guidelines - HEMP protection concepts
IEC/TS 61000-5-4	Electromagnetic compatibility (EMC) - Part 5: Installation and mitigation guidelines - Section 4: Immunity to HEMP - Specifications for protective devices against HEMP radiated disturbance. Basic EMC Publication
IEC 61000-5-5	Electromagnetic compatibility (EMC) - Part 5: Installation and mitigation guidelines - Section 5: Specification of protective devices for HEMP conducted disturbance. Basic EMC Publication
IEC/TR 61000-5-6	Electromagnetic compatibility (EMC) - Part 5-6: Installation and mitigation guidelines - Mitigation of external EM influences
IEC 61000-5-7	Electromagnetic compatibility (EMC) - Part 5-7: Installation and mitigation guidelines - Degrees of protection provided by enclosures against electromagnetic disturbances (EM code)
IEC 61000-5-8	Electromagnetic compatibility (EMC) - Part 5-8: Installation and mitigation guidelines - HEMP protection methods for the distributed infrastructure
IEC 61000-5-9	Electromagnetic compatibility (EMC) - Part 5-9: Installation and mitigation guidelines - System-level susceptibility assessments for HEMP and HPEM
IEC 61000-6-1	Electromagnetic compatibility (EMC) - Part 6-1: Generic standards - Immunity standard for residential, commercial and light-industrial environments
IEC 61000-6-2	Electromagnetic compatibility (EMC) - Part 6-2: Generic standards - Immunity standard for industrial environments
IEC 61000-6-3	Electromagnetic compatibility (EMC) - Part 6-3: Generic standards - Emission standard for residential, commercial and light-industrial environments
IEC 61000-6-4	Electromagnetic compatibility (EMC) - Part 6-4: Generic standards - Emission standard for industrial environments
IEC 61000-6-5	Electromagnetic compatibility (EMC) - Part 6-5: Generic standards - Immunity for power station and substation environments
IEC 61000-6-6	Electromagnetic compatibility (EMC) - Part 6-6: Generic standards - HEMP immunity for indoor equipment
IEC 61000-6-7	Electromagnetic compatibility (EMC) - Part 6-7: Generic standards - Immunity requirements for equipment intended to perform functions in a safety-related system (functional safety) in industrial locations
IEC 61326-1	Electrical equipment for measurement, control and laboratory use - EMC requirements - Part 1: General requirements
IEC 61326-2-1	Electrical equipment for measurement, control and laboratory use - EMC requirements - Part 2-1: Particular requirements - Test configurations, operational conditions and performance criteria for sensitive test and measurement equipment for EMC unprotected applications
IEC 61326-2-2	Electrical equipment for measurement, control and laboratory use - EMC requirements - Part 2-2: Particular requirements - Test configurations, operational conditions and performance criteria for portable test, measuring and monitoring equipment used in low-voltage distribution systems

IEC (continued)	
Document Number	Title
IEC 61326-2-3	Electrical equipment for measurement, control and laboratory use - EMC requirements - Part 2-3: Particular requirements - Test configuration, operational conditions and performance criteria for transducers with integrated or remote signal conditioning
IEC 61326-2-4	Electrical equipment for measurement, control and laboratory use - EMC requirements - Part 2-4: Particular requirements - Test configurations, operational conditions and performance criteria for insulation monitoring devices according to IEC 61557-8 and for equipment for insulation fault location according to IEC 61557-9
IEC 61326-2-5	Electrical equipment for measurement, control and laboratory use - EMC requirements - Part 2-5: Particular requirements - Test configurations, operational conditions and performance criteria for field devices with field bus interfaces according to IEC 61784-1
IEC 61326-2-6	Electrical equipment for measurement, control and laboratory use - EMC requirements - Part 2-6: Particular requirements - In vitro diagnostic (IVD) medical equipment
IEC 61326-3-1	Electrical equipment for measurement, control and laboratory use - EMC requirements - Part 3-1: Immunity requirements for safety-related systems and for equipment intended to perform safety-related functions (functional safety) - General industrial applications
IEC 61326-3-2	Electrical equipment for measurement, control and laboratory use - EMC requirements - Part 3-2: Immunity requirements for safety-related systems and for equipment intended to perform safety-related functions (functional safety) - Industrial applications with specified electromagnetic environment
IEC 61340-3-1	Electrostatics - Part 3-1: Methods for simulation of electrostatic effects - Human body model (HBM) electrostatic discharge test waveforms
IEC 61543	Residual current-operated protective devices (RCDs) for household and similar use - Electromagnetic compatibility
IEC 61800-3	Adjustable speed electrical power drive systems - Part 3: EMC requirements and specific test methods
IEC 61967-1	Integrated circuits - Measurement of electromagnetic emissions, 150 kHz to 1 GHz - Part 1: General conditions and definitions
IEC 62040-2	Uninterruptible power systems (UPS) - Part 2: Electromagnetic compatibility (EMC) requirements
IEC 62041	Power transformers, power supply units, reactors and similar products - EMC requirements
IEC 62153-4-0	Metallic communication cable test methods - Part 4-0: Electromagnetic compatibility (EMC) - Relationship between surface transfer impedance and screening attenuation, recommended limits
IEC 62153-4-1	Metallic communication cable test methods - Part 4-1: Electromagnetic compatibility (EMC) - Introduction to electromagnetic screening measurements
IEC 62153-4-2	Metallic communication cable test methods - Part 4-2: Electromagnetic compatibility (EMC) - Screening and coupling attenuation - Injection clamp method
IEC 62153-4-3	Metallic communication cable test methods - Part 4-3: Electromagnetic compatibility (EMC) - Surface transfer impedance - Triaxial method
IEC 62153-4-4	Metallic communication cable test methods - Part 4-4: Electromagnetic compatibility (EMC) - Test method for measuring of the screening attenuation as up to and above 3 GHz, triaxial method
IEC 62153-4-5	Metallic communication cables test methods - Part 4-5: Electromagnetic compatibility (EMC) - Coupling or screening attenuation - Absorbing clamp method

IEC (continued)	
Document Number	Title
IEC 62153-4-6	Metallic communication cable test methods - Part 4-6: Electromagnetic compatibility (EMC) - Surface transfer impedance - Line injection method
IEC 62153-4-7	Metallic communication cable test methods - Part 4-7: Electromagnetic compatibility (EMC) - Test method for measuring of transfer impedance ZT and screening attenuation aS or coupling attenuation aC of connectors and assemblies up to and above 3 GHz - Triaxial tube in tube method
IEC 62153-4-8	Metallic communication cable test methods - Part 4-8: Electromagnetic compatibility (EMC) - Capacitive coupling admittance
IEC 62153-4-9	Metallic communication cable test methods - Part 4-9: Electromagnetic compatibility (EMC) - Coupling attenuation of screened balanced cables, triaxial method
IEC 62153-4-10	Metallic communication cable test methods - Part 4-10: Electromagnetic compatibility (EMC) - Transfer impedance and screening attenuation of feed-throughs and electromagnetic gaskets - Double coaxial test method
IEC 62153-4-11	Metallic communication cable test methods - Part 4-11: Electromagnetic compatibility (EMC) - Coupling attenuation or screening attenuation of patch cords, coaxial cable assemblies, pre-connectorized cables - Absorbing clamp method
IEC 62153-4-12	Metallic communication cable test methods - Part 4-12: Electromagnetic compatibility (EMC) - Coupling attenuation or screening attenuation of connecting hardware - Absorbing clamp method
IEC 62153-4-13	Metallic communication cable test methods - Part 4-13: Electromagnetic compatibility (EMC) - Coupling attenuation of links and channels (laboratory conditions) - Absorbing clamp method
IEC 62153-4-14	Metallic communication cable test methods - Part 4-14: Electromagnetic compatibility (EMC) - Coupling attenuation of cable assemblies (Field conditions) absorbing clamp method
IEC 62153-4-15	Metallic communication cable test methods - Part 4-15: Electromagnetic compatibility (EMC) - Test method for measuring transfer impedance and screening attenuation - or coupling attenuation with triaxial cell
IEC 62236-1	Railway applications - Electromagnetic compatibility - Part 1: General
IEC 62236-2	Railway applications - Electromagnetic compatibility - Part 2: Emission of the whole railway system to the outside world
IEC 62236-3-1	Railway applications - Electromagnetic compatibility - Part 3-1: Rolling stock - Train and complete vehicle
IEC 62236-3-2	Railway applications - Electromagnetic compatibility - Part 3-2: Rolling stock - Apparatus
IEC 62236-4	Railway applications - Electromagnetic compatibility - Part 4: Emission and immunity of the signalling and telecommunications apparatus
IEC 62236-5	Railway applications - Electromagnetic compatibility - Part 5: Emission and immunity of fixed power supply installations and apparatus
IEC 62305-1	Protection against lightning - Part 1: General principles
IEC 62305-2	Protection against lightning - Part 2: Risk management
IEC 62305-3	Protection against lightning - Part 3: Physical damage to structures and life hazard

IEC (continued)	
Document Number	Title
IEC 62305-4	Protection against lightning - Part 4: Electrical and electronic systems within structures
IEC 62310-2	Static transfer systems (STS) - Part 2: Electromagnetic compatibility (EMC) requirements
IEC/TR 62482	Electrical installations in ships - Electromagnetic compatibility - Optimising of cable installations on ships - Testing method of routing distance

CISPR	
Document Number	Title
CISPR 11	Industrial, scientific and medical (ISM) radio-frequency equipment - Electromagnetic disturbance characteristics - Limits and methods of measurement
CISPR 12	Vehicles, boats and internal combustion engines - Radio disturbance characteristics - Limits and methods of measurement for the protection of off-board receivers
CISPR 13	Sound and television broadcast receivers and associated equipment - Radio disturbance characteristics - Limits and methods of measurement
CISPR 14-1	Electromagnetic compatibility - Requirements for household appliances, electric tools and similar apparatus - Part 1: Emission
CISPR 14-2	Electromagnetic compatibility - Requirements for household appliances, electric tools and similar apparatus - Part 2: Immunity - Product family standard
CISPR 15	Limits and methods of measurement of radio disturbance characteristics of electrical lighting and similar equipment
CISPR 16-1-1	Specification for radio disturbance and immunity measuring apparatus and methods - Part 1-1: Radio disturbance and immunity measuring apparatus - Measuring apparatus
CISPR 16-1-2	Specification for radio disturbance and immunity measuring apparatus and methods - Part 1-2: Radio disturbance and immunity measuring apparatus - Coupling devices for conducted disturbance measurements
CISPR 16-1-3	Specification for radio disturbance and immunity measuring apparatus and methods - Part 1-3: Radio disturbance and immunity measuring apparatus - Ancillary equipment - Disturbance power
CISPR 16-1-4	Specification for radio disturbance and immunity measuring apparatus and methods - Part 1-4: Radio disturbance and immunity measuring apparatus - Antennas and test sites for radiated disturbance measurements
CISPR 16-1-5	Specification for radio disturbance and immunity measuring apparatus and methods - Part 1-5: Radio disturbance and immunity measuring apparatus - Antenna calibration sites and reference test sites for 5 MHz to 18 GHz
CISPR 16-1-6	Specification for radio disturbance and immunity measuring apparatus and methods - Part 1-6: Radio disturbance and immunity measuring apparatus - EMC antenna calibration
CISPR 16-2-1	Specification for radio disturbance and immunity measuring apparatus and methods - Part 2-1: Methods of measurement of disturbances and immunity - Conducted disturbance measurements
CISPR 16-2-2	Specification for radio disturbance and immunity measuring apparatus and methods - Part 2-2: Methods of measurement of disturbances and immunity - Measurement of disturbance power
CISPR 16-2-3	Specification for radio disturbance and immunity measuring apparatus and methods - Part 2-3: Methods of measurement of disturbances and immunity - Radiated disturbance measurements

CISPR (continued)	
Document Number	Title
CISPR 16-2-4	Specification for radio disturbance and immunity measuring apparatus and methods - Part 2-4: Methods of measurement of disturbances and immunity - Immunity measurements
CISPR TR 16-2-5	Specification for radio disturbance and immunity measuring apparatus and methods - Part 2-5: In situ measurements for disturbing emissions produced by physically large equipment
CISPR TR 16-3	Specification for radio disturbance and immunity measuring apparatus and methods - Part 3: CISPR technical reports
CISPR TR 16-4-1	Specification for radio disturbance and immunity measuring apparatus and methods - Part 4-1: Uncertainties, statistics and limit modelling - Uncertainties in standardized EMC tests
CISPR 16-4-2	Specification for radio disturbance and immunity measuring apparatus and methods - Part 4-2: Uncertainties, statistics and limit modelling - Measurement instrumentation uncertainty
CISPR TR 16-4-3	Specification for radio disturbance and immunity measuring apparatus and methods - Part 4-3: Uncertainties, statistics and limit modelling - Statistical considerations in the determination of EMC compliance of mass-produced products
CISPR TR 16-4-4	Specification for radio disturbance and immunity measuring apparatus and methods - Part 4-4: Uncertainties, statistics and limit modelling - Statistics of complaints and a model for the calculation of limits for the protection of radio services
CISPR TR 16-4-5	Specification for radio disturbance and immunity measuring apparatus and methods - Part 4-5: Uncertainties, statistics and limit modelling - Conditions for the use of alternative test methods
CISPR 17	Methods of measurement of the suppression characteristics of passive EMC filtering devices
CISPR TR 18-1	Radio interference characteristics of overhead power lines and high-voltage equipment - Part 1: Description of phenomena
CISPR TR 18-2	Radio interference characteristics of overhead power lines and high-voltage equipment - Part 2: Methods of measurement and procedure for determining limits
CISPR TR 18-3	Radio interference characteristics of overhead power lines and high-voltage equipment - Part 3: Code of practice for minimizing the generation of radio noise
CISPR 20	Sound and television broadcast receivers and associated equipment - Immunity characteristics - Limits and methods of measurement
CISPR 22	Information technology equipment - Radio disturbance characteristics - Limits and methods of measurement
CISPR 24	Information technology equipment - Immunity characteristics - Limits and methods of measurement
CISPR 25	Vehicles, boats and internal combustion engines - Radio disturbance characteristics - Limits and methods of measurement for the protection of on-board receivers
CISPR 32	Electromagnetic compatibility of multimedia equipment - Emission requirements
CISPR 35	Electromagnetic compatibility of multimedia equipment - Immunity requirements

ISO	
Document Number	Title
ISO 13766:2006	Earth-moving machinery -- Electromagnetic compatibility



Engineered Marketing For
The Electronics Industry

Understand your customers' digital footprints to better understand their journey.

- Lead Qualification
- Lead Generation
- Audience Development
- Online Events
- Content Creation
- Technology Implementation
- Big Data Translation
- ...and *MORE!*

Start your journey today!

please visit

item.media

EUROPEAN & INTERNATIONAL STANDARDS UPDATES

List of Common EMC Standards

You shouldn't be surprised that Wikipedia has a comprehensive list of EMC standards. The list includes CISPR, IEC, ISO, European EN, FCC, and MIL-STD. There is also a link to the GR-1089-CORE EMC and product safety standards for network telecommunications equipment. A good link to bookmark. For more, [Click here](#).

EU: NEW CENELEC STANDARDS RECENTLY RELEASED

- **EN ISO/IEC 17011:2017** - 12/13/2017 - Conformity assessment - Requirements for accreditation bodies accrediting conformity assessment bodies (ISO/IEC 17011:2017)
- **EN ISO/IEC 17025:2017** - 12/13/2017 - General requirements for the competence of testing and calibration laboratories (ISO/IEC 17025:2017)
- **CLC/TR 50669:2017** - 12/15/2017 - Investigation Results on Electromagnetic Interference in the Frequency Range below 150 kHz
- **EN 16602-40:2018** - (4/18/18) - Space product assurance - Safety
- **EN 50364:2018** - 1/12/2018 - Product standard for human exposure to electromagnetic fields from devices operating in the frequency range 0 Hz to 300 GHz, used in Electronic Article Surveillance (EAS), Radio Frequency Identification (RFID) and similar applications
- **EN 50443:2011** - (3/14/18) - Effects of electromagnetic interference on pipelines caused by high voltage a.c. electric traction systems and/or high voltage a.c. power supply systems
- **EN 50496:2018** - (3/16/18) - Determination of workers' exposure to electromagnetic fields and assessment of risk at a broadcast site
- **EN 50527-2-2:2018** - 5/11/2018 - Procedure for the assessment of the exposure to electromagnetic fields of workers bearing active implantable medical devices - Part 2-2: Specific assessment for workers with cardioverter defibrillators (ICDs)
- **EN 50636-2-107:2015/A1:2018** - 1/12/2018 - Safety of household and similar appliances - Part 2-107: Particular requirements for robotic battery powered electrical lawnmowers
- **CLC/TR 50442:2018** - 1/19/2018 - Guidelines for product committees on the preparation of standards related to human exposure from electromagnetic fields
- **EN IEC 60079-7:2015/A1:2018** - 1/19/2018 - Explosive atmospheres - Part 7: Equipment protection by increased safety "e"
- **EN IEC 60519-12:2018** - (March 2018) - Safety in installations for electroheating and electromagnetic processing - Part 12: Particular requirements for infrared electroheating
- **EN 60598-1:2015/A1:2018** - (February 2018) - Luminaires - Part 1: General requirements and tests
- **EN IEC 61010-2-120:2018** - (4/13/18) - Safety requirements for electrical equipment for measurement, control, and laboratory use - Part 2-120: Particular safety requirements for machinery aspects of equipment
- **EN 61000-6-5:2015/AC:2018-01** - 1/19/2018 - Electromagnetic compatibility (EMC) - Part 6-5: Generic standards - Immunity for equipment used in power station and substation environment
- **EN IEC 61204-7:2018** - (3/16/18) - Low-voltage switch mode power supplies - Part 7: Safety requirements
- **EN 61400-22:2011** - 5/16/2018 - Wind turbines - Part 22: Conformity testing and certification
- **EN IEC 61730-1:2018** - (4/27/18) - Photovoltaic (PV) module safety qualification - Part 1: Requirements for construction
- **EN IEC 61730-2:2018** - (4/27/18) - Photovoltaic (PV) module safety qualification - Part 2: Requirements for testing
- **EN IEC 60601-2-2:2018** - 5/18/2018 - Medical electrical equipment - Part 2-2: Particular requirements for the basic safety and essential performance of high frequency surgical equipment and high frequency surgical accessories

- **EN 60601-2-43:2010/A1:2018** - 5/18/2018 - Medical electrical equipment - Part 2-43: Particular requirements for the basic safety and essential performance of X-ray equipment for interventional procedures
 - **EN 62053-11:2003/A1:2017/AC:2018-05** - 5/4/2018 - Electricity metering equipment (a.c.) - Particular requirements - Part 11: Electromechanical meters for active energy (classes 0,5, 1 and 2)
 - **EN 62053-21:2003/A1:2017/AC:2018-05** - 5/4/2018 - Electricity metering equipment (a.c.) - Particular requirements - Part 21: Static meters for active energy (classes 1 and 2)
 - **EN 62053-22:2003/A1:2017/AC:2018-05** - 5/4/2018 - Electricity metering equipment (a.c.) - Particular requirements - Part 22: Static meters for active energy (classes 0,2 S and 0,5 S)
 - **EN 62053-23:2003/A1:2017/AC:2018-05** - 5/4/2018 - Electricity metering equipment (a.c.) - Particular requirements - Part 23: Static meters for reactive energy (classes 2 and 3)
 - **EN 62053-24:2015/A1:2017/AC:2018-05** - 5/4/2018 - Electricity metering equipment (a.c.) - Particular requirements - Part 24: Static meters for reactive energy at fundamental frequency (classes 0,5 S, 1 S and 1)
 - **EN IEC 62228-1:2018** - 6/1/2018 - Integrated circuits - EMC evaluation of transceivers - Part 1: General conditions and definitions
 - **EN IEC 62485-1:2018** - 5/4/2018 - Safety requirements for secondary batteries and battery installations - Part 1: General safety information
 - **EN IEC 62485-2:2018** - 5/4/2018 - Safety requirements for secondary batteries and battery installations - Part 2: Stationary batteries
 - **EN IEC 62485-4:2018** - 5/4/2018 - Safety requirements for secondary batteries and battery installations - Part 4: Valve-regulated lead-acid batteries for use in portable appliances
 - **EN 62489-1:2010/A2:2018** - (February 2018) - Electroacoustics - Audio-frequency induction loop systems for assisted hearing - Part 1: Methods of measuring and specifying the performance of system components
 - **EN IEC 60749-26:2018** - (3/23/18) - Semiconductor devices - Mechanical and climatic test methods - Part 26: Electrostatic discharge (ESD) sensitivity testing - Human body model (HBM)
 - **EN IEC 62822-3:2018** - (February 2018) - Electric welding equipment - Assessment of restrictions related to human exposure to electromagnetic fields (0 Hz to 300 Hz) - Part 3: Resistance welding equipment
 - **EN IEC 62828-1:2018** - (February 2018) - Reference conditions and procedures for testing industrial and process measurement transmitters - Part 1: General procedures for all types of transmitters
 - **EN 62927:2017/AC:2018-01** - 1/19/2018 - Voltage sourced converter (VSC) valves for static synchronous compensator (STATCOM) - Electrical Testing
 - **EN IEC 63044-3:2018 - 1/19/2018** - Home and Building Electronic Systems (HBES) and Building Automation and Control Systems (BACS) - Part 3: Electrical safety requirements
 - **EN 55016-1-2:2014/A1:2018** - 2/2/2018 - Specification for radio disturbance and immunity measuring apparatus and methods - Part 1-2: Radio disturbance and immunity measuring apparatus - Coupling devices for conducted disturbance measurements
- See CENELEC for additional information.
- EU: NEW ETSI STANDARDS RECENTLY RELEASED**
- **ETSI EN 300 718-1 V2.1.1** - (January 2018) - Avalanche Beacons operating at 457 kHz; Transmitter-receiver systems; Part 1: Harmonised Standard for access to radio spectrum
 - **ETSI EN 300 718-2 V2.1.1** - (January 2018) - Avalanche Beacons operating at 457 kHz; Transmitter-receiver systems; Part 2: Harmonised Standard for features for emergency services
 - **ETSI EN 302 245 V2.1.1** - (June 2018) - Transmitting equipment for the Digital Radio Mondiale (DRM) sound broadcasting service; Harmonised Standard for access to radio spectrum
 - **ETSI EN 302 969 V1.3.1** - (May 2018) - Reconfigurable Radio Systems (RRS); Radio Reconfiguration related requirements for Mobile Devices
 - **ETSI EN 303 095 V1.3.1** - (May 2018) - Reconfigurable Radio Systems (RRS); Radio reconfiguration related architecture for Mobile Devices (MD)
 - **ETSI EN 303 316 V1.2.1** - April 2018 - Broadband Direct Air-to-Ground Communications; Equipment operating in the 1 900 MHz to 1 920 MHz and 5 855 MHz to 5 875 MHz frequency bands; Beamforming antennas; Harmonised Standard for access to radio spectrum
 - **ETSI EN 303 454 V1.1.1** - (January 2018) - Short Range Devices (SRD); Metal and object detection sensors in the frequency range 1 kHz to 148,5 kHz; Harmonised Standard covering the essential requirements of article 3.2 of Directive 2014/53/EU
 - **ETSI EN 301 598 V2.1.1** - (January 2018) - White Space Devices (WSD); Wireless Access Systems operating in the 470 MHz to 790 MHz TV broadcast band; Harmonised Standard covering the essential requirements of article 3.2 of Directive 2014/53/EU
 - **ETSI EN 303 980 V1.1.1** - (December 2017) - Satellite Earth Stations and Systems (SES); Harmonised Standard for fixed and in-motion Earth Stations communicating with non-geostationary satellite systems (NEST) in the 11 GHz to 14 GHz frequency bands covering essential requirements of article 3.2 of Directive 2014/53/EU

- **ETSI TS 102 361-4 V1.9.2** - April 2018 - Electromagnetic compatibility and Radio spectrum Matters (ERM); Digital Mobile Radio (DMR) Systems; Part 4: DMR trunking protocol
- **ETSI TS 137 145-2 V14.3.0** - (January 2018) - Universal Mobile Telecommunications System (UMTS); LTE; Active Antenna System (AAS) Base Station (BS) conformance testing; Part 2: radiated conformance testing (3GPP TS 37.145-2 version 14.3.0 Release 14)
- **ETSI TS 137 145-2 V13.5.0** - (January 2018) - Universal Mobile Telecommunications System (UMTS); LTE; Active Antenna System (AAS) Base Station (BS) conformance testing; Part 2: radiated conformance testing (3GPP TS 37.145-2 version 13.5.0 Release 13)
- **ETSI EN 302 054 V2.2.1** - (February 2018) - Meteorological Aids (Met Aids); Radiosondes to be used in the 400,15 MHz to 406 MHz frequency range with power levels ranging up to 200 mW; Harmonised Standard for access to radio spectrum
- **ETSI TR 103 541 V1.1.1** - (May 2018) - Environmental Engineering (EE); Best practice to assess energy performance of future Radio Access Network (RAN) deployment
- **ETSI TR 103 265 V1.2.1** - (February 2018) - Electromagnetic compatibility and Radio spectrum Matters (ERM); Definition of radio parameters
- **IEC 60204:2018, Ed. 1.0** - (2/20/2018) - Safety of machinery - Electrical equipment of machines - ALL PARTS
- **IEC 60939-3:2015/COR2:2018, Ed. 1.0** - 5/7/2018 - Corrigendum 2 - Passive filter units for electromagnetic interference suppression - Part 3: Passive filter units for which safety tests are appropriate
- **IEC 61000-2-2:2002+AMD1:2017+AMD2:2018, Ed. 2.2** - 5/9/2018 - Electromagnetic compatibility (EMC) - Environment - Compatibility levels for low-frequency conducted disturbances and signaling in public low-voltage power supply systems
- **IEC 61000-2-2:2002/AMD2:2018, Ed. 2.0** - 5/9/2018 - Amendment 2 - Electromagnetic compatibility (EMC) - Environment - Compatibility levels for low-frequency conducted disturbances and signaling in public low-voltage power supply systems
- **IEC 61000-6-4:2018, Ed. 3.0** - (2/7/2018) - Electromagnetic compatibility (EMC) - Part 6-4: Generic standards - Emission standard for industrial environments
- **IEC 61000-6-4:2018 RLV, Ed. 3.0** - (2/7/2018) - Electromagnetic compatibility (EMC) - Part 6-4: Generic standards - Emission standard for industrial environments

See ETSI website for additional information.

EU: NEW IEC STANDARDS RECENTLY RELEASED

- **CISPR 15:2018 PRV, Ed. 9.0** - (2/16/2018) - Limits and methods of measurement of radio disturbance characteristics of electrical lighting and similar equipment
- **CISPR 16-1-1:2015/ISH1:2018, Ed. 4.0** - (4/10/18) - Interpretation sheet 1 - Specification for radio disturbance and immunity measuring apparatus and methods - Part 1-1: Radio disturbance and immunity measuring apparatus - Measuring apparatus
- **CISPR 16-4-2/AMD2:2018 PRV, Ed. 2.0** - (4/13/18) - Amendment 2 - Specification for radio disturbance and immunity measuring apparatus and methods - Part 4-2: Uncertainties, statistics and limit modelling - Measurement instrumentation uncertainty
- **IEC TR 61340-1:2012/COR2:2017, Ed. 1.0** - (12/13/2017) - Corrigendum 1 - Electrostatics - Part 1: Electrostatic phenomena - Principles and measurements
- **IEC TR 62905:2018, Ed. 1.0** - (2/6/2018) - Exposure assessment methods for wireless power transfer systems
- **IEC 60068-2:2018, Ed. 1.0** - (2/20/2018) - Environmental testing - Part 2: Tests - ALL PARTS
- **IEC 60079:2018, Ed. 1.0** - (2/20/2018) - Explosive atmospheres - ALL PARTS
- **IEC 60086:2018, Ed. 1.0** - (2/20/2018) - Primary batteries - ALL PARTS
- **IEC 60335-2-76:2018 PRV, Ed. 3.0** - (4/13/18) - Household and similar electrical appliances - Safety - Part 2-76: Particular requirements for electric fence energizers
- **IEC 61340-4-3:2017, Ed. 2.0** - (12/19/2017) - Electrostatics - Part 4-3: Standard test methods for specific applications - Footwear
- **IEC 60601-1:2018, Ed. 1.0** - (2/20/2018) - Medical electrical equipment - ALL PARTS
- **IEC 60825:2018, Ed. 1.0** - (1/8/2018) - Safety of laser products - ALL PARTS
- **IEC PAS 61076-3-126:2018, Ed. 1.0** - (1/9/2018) - Connectors for electrical and electronic equipment - Product requirements - Part 3-126: Rectangular connectors - Detail specification for 5 pole power connector for industrial environments with push-pull locking
- **IEC PAS 63151:2018, Ed. 1.0** - (1/9/2018) - Measurement procedure for the assessment of specific absorption rate of human exposure to radio frequency fields from hand-held and body-mounted wireless communication devices - Vector measurement-based systems (Frequency range of 30 MHz to 6 GHz)
- **IEC 61097-7:1996+AMD1:2018, Ed. 1.1** - (1/10/2018) - Global maritime distress and safety system (GMDSS) - Part 7: Shipborne VHF radiotelephone transmitter and receiver - Operational and performance requirements, methods of testing and required test results

- **IEC 61097-7:1996/AMD1:2018, Ed. 1.0** - (1/10/2018) - Amendment 1 - Global maritime distress and safety system (GMDSS) - Part 7: Shipborne VHF radiotelephone transmitter and receiver - Operational and performance requirements, methods of testing and required test results
- **IEC 62153-4-7:2015/AMD1:2018, Ed. 2.0** - 5/9/2018 - Amendment 1 - Metallic communication cable test methods - Part 4-7: Electromagnetic compatibility (EMC) - Test method for measuring of transfer impedance ZT and screening attenuation aS or coupling attenuation aC of connectors and assemblies up to and above 3 GHz - Triaxial tube in tube method
- **IEC 62153-4-7:2015+AMD1:2018, Ed. 2.1** - 5/9/2018 - Metallic communication cable test methods - Part 4-7: Electromagnetic compatibility (EMC) - Test method for measuring of transfer impedance ZT and screening attenuation aS or coupling attenuation aC of connectors and assemblies up to and above 3 GHz - Triaxial tube in tube method
- **IEC 62153-4-17:2018, Ed. 1.0** - 5/11/2018 - Metallic cables and other passive components - Test methods - Part 4-17: Electromagnetic compatibility (EMC) - Reduction factor
- **IEC 62228-1:2018, Ed. 1.0** - (1/15/2018) - Integrated circuits - EMC evaluation of transceivers - Part 1: General conditions and definitions
- **IEC 60335-2-5:2012/AMD1:2018, Ed. 6.0** - (2/9/2018) - Amendment 1 - Household and similar electrical appliances - Safety - Part 2-5: Particular requirements for dishwashers
- **IEC 60364-4-44:2007+AMD1:2015+AMD2:2018, Ed. 2.2** - (1/16/2018) - Low-voltage electrical installations - Part 4-44: Protection for safety - Protection against voltage disturbances and electromagnetic disturbances
- **IEC 60364-4-44:2007/AMD2:2018, Ed. 2.0** - (1/16/2018) - Amendment 2 - Low-voltage electrical installations - Part 4-44: Protection for safety - Protection against voltage disturbances and electromagnetic disturbances
- **IEC 61162-460:2018, Ed. 2.0** - (1/19/2018) - Maritime navigation and radiocommunication equipment and systems - Digital interfaces - Part 460: Multiple talkers and multiple listeners - Ethernet interconnection - Safety and security
- **IEC 60335-2-114:2018, Ed. 1.0** - (1/26/2018) - Household and similar electrical appliances - Safety - Part 2-114: Particular requirements for self-balancing personal transport devices for use with batteries containing alkaline or other non-acid electrolytes
- **IEC 61000-3-2:2018, Ed. 5.0** - (1/26/2018) - Electromagnetic compatibility (EMC) - Part 3-2: Limits - Limits for harmonic current emissions (equipment input current ≤ 16 A per phase)
- **IEC 61000-3-2:2018, Ed. 5.0** - (1/26/2018) - Electromagnetic compatibility (EMC) - Part 3-2: Limits - Limits for harmonic current emissions (equipment input current ≤ 16 A per phase)
- **IEC 61000-3:2018, Ed. 1.0** - (1/29/2018) - Electromagnetic compatibility (EMC) - Part 3: Limit - ALL PARTS
- **IEC 61010-031:2015/AMD1:2018, Ed. 2.0** - 5/29/2018 - Amendment 1 - Safety requirements for electrical equipment for measurement, control and laboratory use - Part 031: Safety requirements for hand-held and hand-manipulated probe assemblies for electrical test and measurement.
- **IEC 61010-031:2015+AMD1:2018, Ed. 2.1** - 5/29/2018 - Safety requirements for electrical equipment for measurement, control and laboratory use - Part 031: Safety requirements for hand-held and hand-manipulated probe assemblies for electrical test and measurement.
- **IEC 61340-4-4:2018, Ed. 3.0** - (1/30/2018) - Electrostatics - Part 4-4: Standard test methods for specific applications - Electrostatic classification of flexible intermediate bulk containers (FIBC)
- **IEC 61340-4-4:2018, Ed. 3.0** - (1/30/2018) - Electrostatics - Part 4-4: Standard test methods for specific applications - Electrostatic classification of flexible intermediate bulk containers (FIBC)
- **IEC 61340-6-1:2018, Ed. 1.0** - 6/1/2018 - Electrostatics - Part 6-1: Electrostatic control for healthcare - General requirements for facilities
- **IEC 62153-4-7/AMD1:2018, Ed. 2.0** - (2/2/2018) - Metallic communication cable test methods - Part 4-7: Electromagnetic compatibility (EMC) - Test method for measuring of transfer impedance ZT and screening attenuation aS or coupling attenuation aC of connectors and assemblies up to and above 3 GHz - Triaxial tube in tube method
- **IEC 62153-4-8:2018 PRV, Ed. 2.0** - (4/6/18) - Metallic cables and other passive components - Test methods - Part 4-8: Electromagnetic compatibility (EMC) - Capacitive coupling admittance
- **IEC 62153-4-9:2018 RLV** - 5/29/2018 - Metallic communication cable test methods - Part 4 - 9: Electromagnetic compatibility (EMC) - Coupling attenuation of screened balanced cables, triaxial method
- **IEC 62153-4-9:2018, Ed. 2.0** - 5/29/2018 - Metallic communication cable test methods - Part 4 - 9: Electromagnetic compatibility (EMC) - Coupling attenuation of screened balanced cables, triaxial method
- **IEC 62236-1:2018, Ed. 3.0** - (2/9/2018) - Railway applications - Electromagnetic compatibility - Part 1: General
- **IEC 62236-1:2018 RLV, Ed. 3.0** - (2/9/2018) - Railway applications - Electromagnetic compatibility - Part 1: General
- **IEC 62236-2:2018, Ed. 3.0** - (2/9/2018) - Railway applications - Electromagnetic compatibility - Part 2: Emission of the whole railway system to the outside world

- **IEC 62236-2:2018 RLV, Ed. 3.0** - (2/9/2018) - Railway applications - Electromagnetic compatibility - Part 2: Emission of the whole railway system to the outside world
- **IEC 62236-3-1:2018, Ed. 3.0** - (2/15/18) - Railway applications - Electromagnetic compatibility - Part 3-1: Rolling stock - Train and complete vehicle
- **IEC 62236-4:2018 RLV, Ed. 3.0** - (2/15/2018) - Railway applications - Electromagnetic compatibility - Part 4: Emission and immunity of the signalling and telecommunications apparatus
- **IEC 62368-1:2018, Ed. 3.0** - 5/25/2018 - Audio/video, information and communication technology equipment - Part 1: Safety requirements
- **IEC TS 62915:2018, Ed. 1.0** - 5/7/2018 - Photovoltaic (PV) modules - Type approval, design and safety qualification - Retesting
- **IEC 62988:2018 PRV, Ed. 1.0** - (2/16/2018) - Nuclear power plants - Instrumentation and control systems important to safety - Selection and use of wireless devices
- **IEC 62995:2018 PRV, Ed. 1.0** - (2/9/2018) - Railway applications - Rolling stock - Rules for installation of cabling
- **ISO 80601-2-55:2018, Ed. 2.0** - (2/12/2018) - Medical electrical equipment - Part 2-55: Particular requirements for the basic safety and essential performance of respiratory gas monitors

See IEC for additional information.

CANADA

Canada's Innovation, Science and Economic Development (ISED) published Radio Standards Specification 133, Issue 6, 2 GHz Personal Communications Services, replacing Issue 5 dated February 2009. Canada's Innovation, Science and Economic Development (ISED) released Procedure for the Recognition of Foreign Testing Labo-

ratories, Issue 6 (RECLAB, Issue 6) describing the criteria and procedure for recognition by ISED of foreign testing laboratories to test to Canadian requirements for telecommunications terminal equipment, radio apparatus (NEW) and broadcasting equipment (NEW) standards.

Canada's Innovation, Science and Economic Development (ISED) published Radio Standards Specification 140 (RSS140), Issue 1, Equipment Operating in the Public Safety Broadband Frequency Bands 758768 MHz and 788-798 MHz, setting out the certification requirements for equipment operating in the public safety broadband frequency bands 758768 MHz and 788798 MHz.

Canada's Innovation, Science and Economic Development (ISED) published Radio Standards Specification RSSGen, Issue 5, General Requirements for Compliance of Radio Apparatus, replacing prior version RSSGen, issue 4, dated November 2014.

CHINA

China's Certification and Accreditation Administration (CNCA) published an update for its CCC mark. As of March 20, 2018, CCC mark printing no longer needs to be approved by the CNCA, and the CCC mark application fee has been eliminated. Manufacturers may now print and use the CCC mark per the CNCA regulation.

EU

The European Commission published National language requirements for the Radio Equipment Directive (RED; 2014/53/EU).

UKRAINE

In accordance with Decree #355 of the Council of Ministers of Ukraine, a new Technical Regulation based upon the Radio Equipment Directive (RED) 2014/53/EC of the European Parliament and of the Council, will come into effect for radio-based products in Ukraine. This regulation includes a transition period until April 1, 2019 during which manufacturers may continue to ship products approved under the R&TTE.





APRIL 23 - 25, 2019

EMCLIVE 2019

ONLINE EVENT

Join industry leaders as they share and discuss the latest in EMI/EMC technology. 3 days of practical, important and useful EMC information for electronics engineers. And it's FREE.

For more information about
Technical Presentations, Roundtables, Product Demos,
Whitepapers and Resources please visit:

emc.live

EMCLIVE 2019

Presented by

it INTERFERENCE
TECHNOLOGY

EU FLIGHT EXPERIENCE: BRIEF INTRODUCTION TO CE MARKING AND EMC EU STANDARDS FOR ELECTRONIC PRODUCTS

Claudio Stazzone

Eurofins Product Testing
claudiostazzone@gmail.com

"Devices and systems, we are now landing on EU. Please provide your EMC reports and Declarations of Conformity. Remain seated up to the end of tests. Thank you, and happy landing!" This could be the announcement for all the products put into EU market. Of course, EMC is only one of the great number of tests, measurements, inspections, that a product should undergo in order to have the glorious "CE marking" on its label.

EMC is definitely the most underestimated, unknown, and mysterious set of measurements that a device should pass. With this article I will try to clear things up, in order to make our way out from this jungle made of standards...

I will go through the following subjects:

- Regulatory framework versus product: how can I find the right EMC standard for my device?
- Intended use of a device versus regulatory framework: does the chosen regulatory framework address the correct intended use of my device?
- CE marking rules: CE device vs CE systems... CE device + CE device = CE system?

All these items are actually questions; problems that trouble our customer's minds...

After that I would like to "sweep" across standards, from the base ones up to the generic civil/industrial ones, to finish with some product standards. Also, I will try to explain what is the meaning of "harmonized standard".

REGULATORY FRAMEWORK VERSUS PRODUCT

When a customer asks me, what standard could be used for his device, he is asking me what Regulatory Framework is applicable to the device he is selling or manufacturing. I personally know EMC labs that leave this hard task to customers. I am not fully in agreement with that, because in some cases the research of a suitable standard is easy, in some others is definitely not an easy task. Hence, the expert EMC lab engineer comes in, and with his knowledge will surely be of great help.

In some cases, customers tell the EMC lab which standard they

want, together with a test plan (often detailed): in these cases, we say to the customer "Chapeau!" (with the meaning of "great! You are a very well-trained customer!").

INTENDED USE VERSUS REGULATORY FRAMEWORK

After having found the right standard, it is necessary to check that the intended use of the device is concurrent to the EMC standard previously chosen. In other words, we have to check if the device is in the scope of the standard, and consistent with its intended use.

Let me use an example: I produce a power supply for medical devices, and I know there is a specific standard (product standard) for power supplies. That standard generically addresses power supplies, but I want to sell my power supply to medical devices manufacturers. So, I have to apply the medical devices EMC standard to my product, and hence other tests and other measurements are to be done, maybe dramatically different, in levels and limits, from those contained into the Power Supply product standard. In this example, the intended use played a heavy role. We should always take it into account.

CE MARKING RULES

Supposing there are different devices that make up a system. For example a power supply, a motor driver, a motor, and a signaling industrial tower. Each of these components are CE marked. We could be led to think that the system is automatically CE marked... well not exactly! Not at all!

The system has to go under a full measurement campaign, and only then, if all the tests and measurements are passed, the manufacturer can issue the Declaration of Conformity and label the system with the CE marking. Why is it necessary to do so? Well, 9 out of 10, you will find that all the different components of the system have been CE marked with different standards. Besides, in order to connect the different components together, you have to route cables and

connections of many kinds. Hence, you add variables and possible means of transportation of the disturbance around the system, changing the "EM shape" of the single component.

Now, having said that, let's have a look at the main standards, widely used in EU. We will stick to the major ones. Before that, let's talk about harmonized standards...what are they? The explanation is clearly written on the European Community website (please see references below).

Standards are issued by Recognized Standards Organizations. If a standard is published in the EU OJ (European Community Official Journal), it is then "harmonized". As soon as a standard is harmonized, every single EU country can add that standard in their own OJ, as is or by changing something throughout the document. Then, a suffix is added, depending of the country: Italy has CEI, UK has BS. Mind that the use of a harmonized standard is voluntary. And now... let's go for the standard list!

Base Standards (derived from IEC standards, they contain test methods, characteristics of test instruments, calibration methods):

- [EN 61000-4-2](#): is about electrostatic discharges application on civil/industrial EUTs
- [EN 61000-4-3](#): method for radiated immunity from 80MHz to 6GHz
- [EN 61000-4-4](#): EFT/B, also known as BURSTs or fast transients. Required on both power supply and signal cables (of more than 3m long)
- [EN 61000-4-5](#): Surge, in order to simulate lightning strike on cables. Required also on screened cables
- [EN 61000-4-6](#): Common mode RF conducted immunity. From 150kHz to 80MHz (some product standards extend up to 230MHz). Required on both power supply and signal cables (of more than 3m long)
- [EN 61000-4-8](#): immunity to magnetic fields at power supply frequency. To be executed at 50Hz and 60Hz.

Generic Standards (they can modify Base standards, applicable is Product Standards are not available):

- [EN 61000-6-1](#): immunity levels for residential and commercial areas
- [EN 61000-6-2](#): immunity levels for industrial areas (where the power supply lines are not directly connected to the public network)
- [EN 61000-6-3](#): emissions limits (both conducted and radiated) for residential and commercial areas
- [EN 61000-6-4](#): emissions limits (both conducted and radiated) for industrial areas
- [EN 61000-6-5](#): NEW ENTRY! Immunity levels for equipment used in power station and substation environment

Product Standards (they identify clearly what kind of devices are in the scope, they can modify Base standards):

[EN 55011](#): this standard addresses EUTs called ISM (industrial, scientific, medical). It contains limits for emissions (both conducted and radiated).

[EN 55032/EN 55024 \(EN 55035\)](#): the scope of these two standards are MME (multimedia equipment). In the previous versions was used the short form ITE (information technology equipment). These two standards supersede the previous EN 55022 (for emissions). For immunity it is still applicable EN 55024 but it will be superseded by EN 55035 (in Italy, not yet harmonized).

[EN 61326-1](#): this standard is about laboratory instruments, control and measurement devices. It defines three different environments: basic, industrial, special (shielded rooms, or areas where EM radiation is under control). The manufactures should choose the environment in advance because levels and limits are not the same for the three environments.

[EN 60601-1-2](#): medical devices and medical equipment. This standard went through a heavy maintenance process. Edition 4 (2014) contains substantial differences and it will be compulsory from the end of 2018. Briefly, the main differences are: more involvement of the manufacturer in the EMC measurement and test process, electrostatic discharges on air at 15kV, increased levels of radiated immunity in certain wireless and communications bands up to 6GHz, additional tests for EUTs installed of light vehicles (included ambulances).

And then, I will end this long article with a final question. Where can I find EU standards? Well, don't try to buy standards from the CEN CENELEC website: you won't find anything. In the References below I give you a link to the CEN CENELEC website, from where you can be redirected to Affiliates and CEN National Members, from where you can download the standards.

REFERENCES

Guide for the EMCD:

<https://ec.europa.eu/docsroom/documents/28323>, to assist with the common application of the Directive 2014/30/EU. The guide has no weight in law, but deals with a number of practical issues that will be of interest to manufacturers and other stakeholders.

Blue Guide:

https://ec.europa.eu/growth/content/blue-guide-2-implementation-eu-product-rules-0_it, the update of the Guide to the implementation of directives based on the New Approach and the Global Approach (the "Blue Guide").

Harmonized standards definition:

https://ec.europa.eu/growth/single-market/european-standards/harmonised-standards_en

CEN CENELEC:

www.cenelec.eu/standards/ENpurchase/Pages/default.aspx

ABOUT THE AUTHOR

Claudio Stazzone works as a Technical Responsible for the EMC Lab of Eurofins Product Testing Italy, Eurofins Scientific Group. In his everyday activity there are EMC measurements with customers, and general management of the EMC activity of the lab from the technical point of view. He is Responsible for the EMC and RED directives for Notified Body activity.

PROPOSED CHANGES TO CISPR SC I STANDARDS

Ghery Pettit

President, Pettit EMC Consulting LLC

Ghery@PettitEMCConsulting.com

Are you familiar with CISPR 32 and CISPR 35? CISPR 32 was originally published in 2012, followed by a pair of corrigenda and then the 2nd edition was published in 2015. CISPR 32 replaced CISPR 13 (Broadcast receivers emissions) and CISPR 22 (ITE emissions). In the EU CISPR 32 is published as EN 55032 and it has superseded EN 55013 and EN 55022. By now you should all be comfortable with CISPR 32 and your labs should be using it.

Likewise, CISPR 35 was published in 2016 and replaces CISPR 24 (ITE immunity). It ultimately will replace CISPR 20, as well. EN 55035 is applicable in the EU for the Radio Equipment Directive, but hasn't been listed for the EMC Directive. This article will leave that discussion alone, but you should be aware of CISPR 35. Korea adopted its own version of CISPR 35 a while ago, but their standard is based on the Committee Draft for Vote (CDV) that resulted in a Final Draft International Standard (FDIS) that failed in voting in CISPR SC I. Confused yet?

It will only get worse. Recall the scene from the original Star Trek movie where Bones McCoy comes aboard the newly remodeled star ship Enterprise and goes off mumbling about having to look at the new sick bay. He knows it will be different, "I know engineers. They love to change things!" I'm sure whoever wrote that line had been around engineers, because it is true. We love to change things. That's what we do.

Why do I bring this up? Because, guess what? Changes for CISPR 32 and CISPR 35 are afoot. Don't worry, the changes won't happen tomorrow, but they are scheduled to happen in late 2019 for CISPR 32 and 2020 for CISPR 35. This is, of course, if all goes according to schedule.

So, what's changing?

CISPR 32

CISPR SC I MT7^[1] is working on Amendment 1 to CISPR 32:2015. There are a bunch of items that they are looking at, and the items were divided up into 6 fragments. Five of these were circulated to the national committees last year as 5 Committee Draft (CD) documents. CDs are commented on by national committees, but they are not voted on. MT7 has reviewed the comments (most recently on February 28 / March 1 of this year in Milan) and is taking the next step on three of them. Fragments 1, 2 and 3 will be circulated as CDVs later this year in time to have voting finished prior to the next meeting of CISPR SC I in October. Fragment 4 deals with termination of the AC mains cables where they leave

the measurement area and this is being dealt with by CISPR SC A. No further work will be done by MT7 on this until SC A amends the appropriate CISPR 16 standards and a CD was not circulated last year for this fragment. Fragment 5 deals with Wireless Power Transfer (WPT) and this work is not mature enough at this time. Finally, fragment 6 deals with the RMS-Average detector and this work, as well, is not mature enough to go forward.

So, what do fragments 1, 2 and 3 impact? A bunch of items.

Fragment 1 deals with a large number of items. Too many to discuss in detail in a blog. A few are close coupling ports^[2], allowable receive antenna positions when running tests, cable length between the EUT and AMN/AAN requirements, and AC mains cable routing. Wording was updated to try and reduce confusion. There is also a point dealing with HDMI cables, but this will be worked further and will not appear in the CDV later this year.

Fragment 2 deals with a few items, the most important of which is a change to Clause 11 of CISPR 32 to require full compliance with the measurement instrumentation uncertainty requirements in CISPR 16-4-2. Watch out for this one.

Fragment 3 primarily deals with suggested changes to the limits and methods of measurement for emissions above 1 GHz. No change in frequency range is being proposed, but the changes proposed will bring CISPR 32 into alignment with the FCC limits from 1 GHz to 3 GHz (some would call this a relaxation in CISPR 32) and the test methods in ANSI C63.4. In other words, height scans for all EUTs, not just those too tall to fit in the 3 dB beam width of the receive antenna. The voting on this CDV, and the comments that go with the negative votes, should be interesting.

In short, there will be 3 CDVs circulated to the national committees later this year after the French translation is prepared. These will deal with fragments 1, 2 and 3. The parts that pass will likely be circulated as a single FDIS in 2019. As the stability date for CISPR 32 is this year (the earliest any amendment could be published), passage of this FDIS will result in an amendment to CISPR 32. A

new stability date will be agreed at the next CISPR SC I plenary meeting following publication of the amendment (late 2019 in Shanghai or late 2020 in San Francisco).

CISPR 35

The work on Amendment 1 to CISPR 35 Edition 1 is not as advanced as the work on amending CISPR 32. An RR document to officially start the work has not been issued, as this would start the clock running as to when the work must be complete. The meeting on February 26 and 27 in Milan was supposed to simply discuss whether or not a particular item should be included in the next amendment. The discussions instead went into details of these items. The original plan was to divide the work into items that were felt to be “easy” and those that would take more work. The “easy” items would be included in the next amendment and the others would follow at some time in the future. While a number of items are under discussion, there will be no documents forwarded to the national committees for comment prior to the next meeting of MT8^[3] in Busan, South Korea next October. Suffice to say, if all goes

as expected there should be an amendment to CISPR 35 published in 2020. More details as they become available.

CONCLUSION

In conclusion, Bones McCoy was correct in his observation in the first Star Trek movie. Engineers do love to change things and CISPR 32 and CISPR 35 are not static standards. Don't get comfortable with the standards as they exist today. Remember, CISPR 22 had 6 editions in its lifetime from 1985 to 2008. These standards won't be any different.

NOTES:

- [1] Maintenance Team 7? Where did this come from? Working Group 2 was dissolved in the CISPR SC I meeting last October and replaced with MT7.
- [2] Much more than can be discussed here, as it took an hour or more to discuss in Milan on February 28.
- [3] MT8 replaced WG4 last October.



AUTOMOTIVE EMC

Maurizio Di Paolo Emilio

Researcher, Ph.D, INFN Istituto Nazionale di Fisica Nucleare
mdipaolo21@gmail.com

Introduction

The rapid development of the automotive industry and the trend towards autonomous vehicles and ADAS systems continue to drive the need for more sophisticated EMC design and test scenarios for the automotive industry. Vehicle platforms become increasingly much more complex with electronic devices that need a reliable function without impacting security or communication infrastructure.

The increase of electronics in automotive systems has not just foreseen a radical change in control systems with ECUs, but also in the communication, information, security and mobile entertainment systems in vehicles. It is important that all the electronic devices of a vehicle are electromagnetically compatible and do not interfere with the systems outboard.

The new wireless communication paradigms applied to the automotive sector require high performance electronic systems that operate at high bitrates and, therefore, at high frequencies according to the operating environment. Each of these new sub-systems must comply with the electromagnetic compatibility (EMC) standards. Furthermore, the integrity of the signals, the transmitted and processed data streams are critical aspects. Miniaturization of electronic products is a must and, as a consequence, manufacturing tolerance can be no longer neglected. Variations in nominal design parameters cause irregular behaviours that negatively affect the EMC and signal integrity and power (SI / PI) aspects.

SIGNAL INTEGRITY

Historically, engineers have used signal integrity testing (SI) as a key part of design and development of new systems and for maintaining standard qualifications. With today's increasing demand for higher system throughput and reduced latency in cloud computing, customers are increasingly designing low-loss laminate materials with more stringent design specifications and tolerances for impedance control.

The integrity analysis continues to evolve by combining simulation models with instrumentation to include detailed measurements of non-uniform trace structures, vias, packages and connectors. As the PCBs become more complex, the lines between the different scopes of analysis become blurred. The concepts of signal and power integrity are closely related.

Power integrity problems in a project can actually appear as signal integrity problems. That's why performing signal integrity analysis is important for creating reliable designs, as well as for understanding and resolving possible problems encountered in the laboratory.

Digital projects traditionally have not been suffered of problems associated with the loss of a transmission line that can have significant consequences on the transmitted data. At low speeds, the frequency response has low influence on the signal.

However, as speed increases, high frequency effects take over and even shorter lines can suffer of interferences such as crosstalk and reflections. In this case, the characteristics of a circuit can be determined as a function of parasitic impedances, which become prevalent along a transmission line.

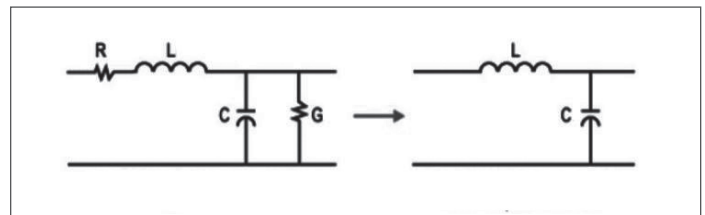

Figure 1: circuit model of a transmission line (on the left) and approximation to the first order (on the right)

An example of circuit model is shown in Figure 1. The impedance plays an important role determining a perfect match of the transmission path of the signal and therefore effects on the quality of the signal. A mismatching between the line, source and load impedances determines a reflection of the signal with consequent energy loss and signal degradation. At high data rates this can cause overshoot of the signal, undershoot and stepped waveforms, which produce signal errors.

The mismatch of impedance can be overcome through the use of circuit schemes with simple parallel (see Figure 2) and more complex RC terminations in which a resistor-capacitor network provides a low-pass filter to remove low-frequency effects but passes the high-frequency signal.

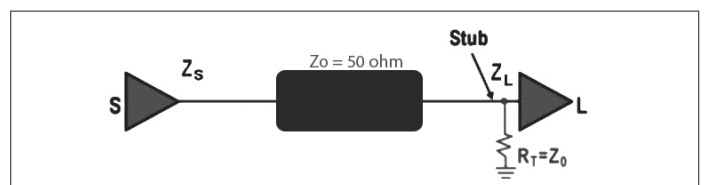

Figure 2: parallel termination circuit diagram

AUTOMOTIVE

Losses in the high frequency signal transmission line make difficult for the receiver to interpret the information correctly. The following two causes of losses in a transmission line are due to the transmission medium:

- Dielectric absorption: high frequency signals excite the molecules in the insulation, reducing signal level. Dielectric absorption refers to the PCB material.
- Skin effect: high frequency signal current tends to travel on the conductors with an increase in the self-inductance of the material. The effective reduction of the conductive material causes an increase in resistance and, therefore, the attenuation of the signal (Figure 3). The density of alternating current J in a conductor decreases exponentially from its value on the surface J_s according to depth d from the surface:

$$\delta = \sqrt{\frac{2\rho}{\omega\mu}} \sqrt{\sqrt{1 + (\rho\omega\epsilon)^2} + \rho\omega\epsilon}$$

Where ρ is the resistivity of the conductor, ω is the angular frequency, μ is the magnetic permeability, ϵ is the permittivity of the material.

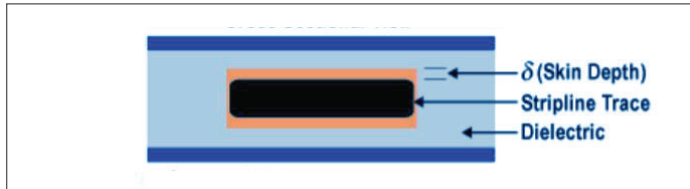

Figure 3: PCB section. The current route is orange. In blue is the ground plane and in celestial is the dielectric of the material. The copper PCB trace is highlighted in black.

CMOS circuits are very popular in many automotive sectors, due to their high speed and very low power dissipation. An ideal CMOS circuit dissipates energy only when it changes state and when the capabilities of the node need to be charged or discharged. In general, a CMOS requires an average of 10 mA and emission limitation techniques are focused on peak voltage and current values rather than average.

The rising current from the power supply on the chips pin is a primary source of emission. By placing a bypass capacitor near each power pin, this problem is limited. Larger capacitors provide strong current peaks, and tend to react badly to high-speed demands. Very small capacitors can react quickly to demand, but their total charge capacity is limited and can quickly run out. The best solution for most circuits is a mix of different sizes of parallel capacitors, perhaps 1- μF and 0.01- μF in parallel.

One area in which automotive designers are interested is in the AM radio band. Most every car is equipped with radios, which has a very sensitive and high gain tuneable amplifier from 500 kHz to 1.5 MHz. Many switching power supplies use switching frequencies within this same band, which leads to problems in automotive applications. As a result, most devices use switching frequencies above this band, often at 2 MHz or higher.

AUTOMOTIVE STANDARD

The automotive industry and the car manufacturers have the aim

of satisfying a variety of requirements regarding electromagnetic compatibility (EMC). For example, two requirements must ensure that electronic devices do not emit excessive electromagnetic interference (EMI) or noise and are immune to noise emitted by other systems.

Automotive systems have several receivers installed around the car. The IEC Commission has formulated international standards to protect them. The international standard for this electromagnetic noise is formulated as CISPR 25, and the power supply on board is required to meet this standard (Figure 4).

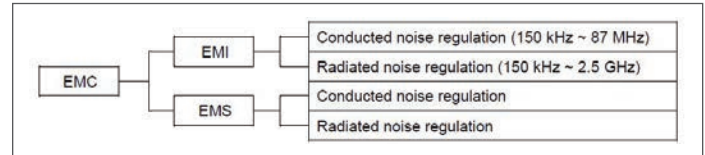

Figure 4: electromagnetic noise

Automotive standards that relate to electromagnetic compatibility (EMC) are mainly developed by CISPR, ISO and SAE. CISPR and ISO are organizations that develop and maintain standards for international use. The CISPR 25 and ISO 11452-2 standards form the basis of most other standards.

CISPR 25 is a standard with different test methods. It requires that the level of test electromagnetic noise is being performed is at least 6 dB lower than the lowest measured levels. Another standard of testing is the ISO 11452-4 Bulk Current Injection (BCI) to check if a component is negatively affected by the narrow band electromagnetic fields. The test is performed by coupling noise directly in the wiring with a current probe.

CISPR 25 contains limits and procedures for measuring radio interference in the frequency range from 150 kHz to 1000 MHz. The standard applies to any electronic / electrical component intended for use on vehicles, trailers and devices. CISPR 25 defines the test configuration as shown in Figure 5 for measuring the noise of the radiation emitted by the apparatus.

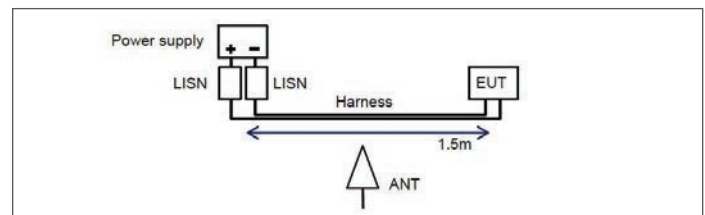

Figure 5: EMI Radiated Noise Test Configuration Example

In the case of irradiated noise measurement of 1 GHz or less, the antenna is placed in the middle of the harness. The wiring current (or voltage) (or LISN) is measured for the conducted noise. The length of the line is different from the test condition for the radiation noise. Therefore, it is important to reduce the noise source level and to prevent noise propagation along the line to reduce EMI noise.

EMC TESTING

When a magnetic field is present, a coil of conductive material can act as an antenna and convert the magnetic field into a current

flowing around the wire. The small size of these loops minimizes the inductive effects of these materials. An example of this effect is when there is a differential data signal. A loop can be formed between the transmitter and the receiver with the differential lines. Another common loop is when two subsystems share a circuit, for example a display and an ECU device.

When a high-speed signal is sent through a transmission line and encounters a change in the characteristic impedance, part of the signal is reflected back and the other continues along the electrical path. Then, reflection leads to emissions.

Emissions can be caused by an interruption in the signal track or in the ground plane. For this it is necessary to avoid sharp angles on the signal track. To minimize reflections on components, it's important to use small components such as size 0402 and set the width of the track equal to the width of the 0402 component.

A recurring topic when trying to solve EMI problems is to reduce dv/dt or di/dt where possible. In this context, DC-DC converters may seem completely harmless until switching regulators are much more efficient than other linear solutions. One area in which automotive designers are interested in creating interference is in the AM radio band. The cars are equipped with AM solutions, which have a very sensitive and high-gain tuneable amplifier from 500 kHz to 1.5 MHz. Most automotive switching supplies use the switching frequencies above this band, often at 2 MHz or higher. If the filter is not sufficient to contain this interference, it can trigger an EMI cycle over the whole circuit.

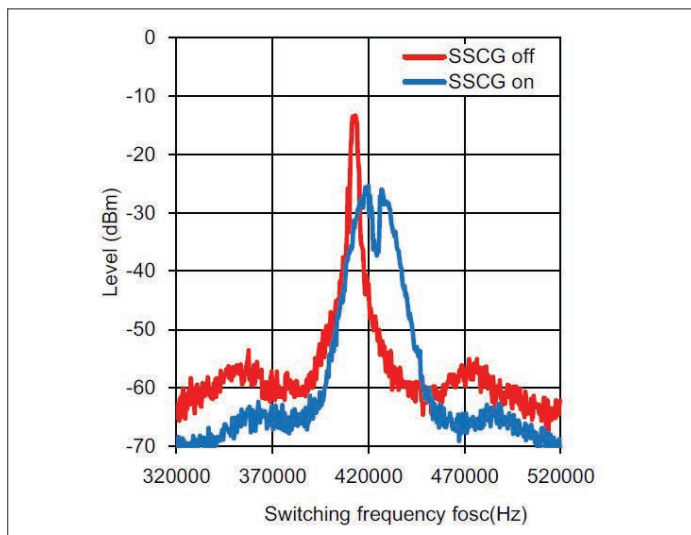

Figure 6: EMI reduction with SSCG

There are several ways to implement EMI noise reduction countermeasures.

Spread Spectrum Clock Generation (SSCG) is a method by which the energy contained in the small band of a clock source is spread on a larger one in a controlled mode, thus reducing the spectral amplitude of the fundamental and harmonics to reduce the emission radiated by the clock. This is obtained by modulating the clock frequency with unique shapes that allow reaching the peak of reduction of the EMI.

By varying the clock frequency on a band in a controlled mode, the time elapsed from the signal at a certain frequency is reduced, and in this way the concentration of energy at any frequency is reduced. So energy is spread on the band of frequencies that reduce the amplitude of the peak.

SSCG provides a way to reach EMC goals. It is an active solution, preserves the integrity of the clock, and can cover a wide range of frequencies. Compared to traditional methods of using passive components such as ferrite beads, RF coils to suppress EMI, SSCG uses an integrated circuit of active components to reduce the EMI peak using frequency modulation (Figure 6).

POWER CIRCUITS

Various electronic devices are mounted on vehicles with different power sources. Switching circuits help power management solutions but are essentially noise sources. Where it is not possible to increase the switching frequency is necessary to introduce noise suppression measures.

DC-DC switching solutions for automotive systems have a switching frequency of 2 MHz, with the exception of some devices. Therefore, there is almost no problem in the range of AM radio (from 530 kHz to 1.8 MHz) as it is below 2 MHz, but countermeasures could be requested with values above 2 MHz. In particular, high noise frequency above 30 MHz is the most important since it generates cases of interference such as to interrupt the correct functioning of a system. A diagram of the step-down DC-DC converter is shown in the following Figure 7.

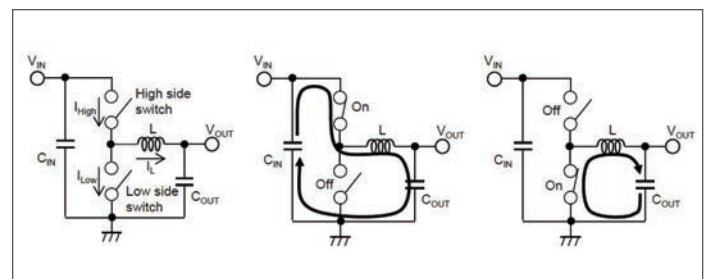

Figure 7: step-down converter with current loop in various cases depending on the switch position

The parasitic inductance of the loop generates a high frequency voltage and therefore noise. To reduce this high frequency, it is necessary to reduce the parasitic inductance and to improve the switching response speed. Noise suppression measures are not limited to vehicles and can also be used with other industrial equipment (Figures 8 and 9).

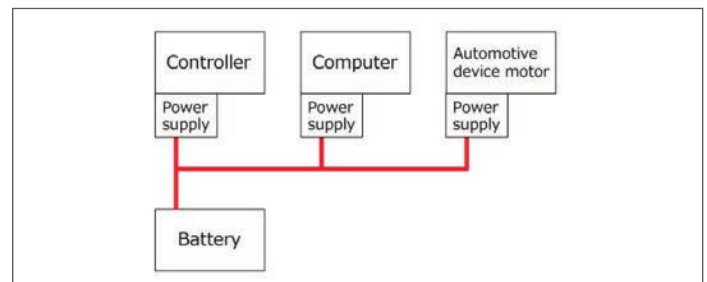

Figure 8: automotive power system

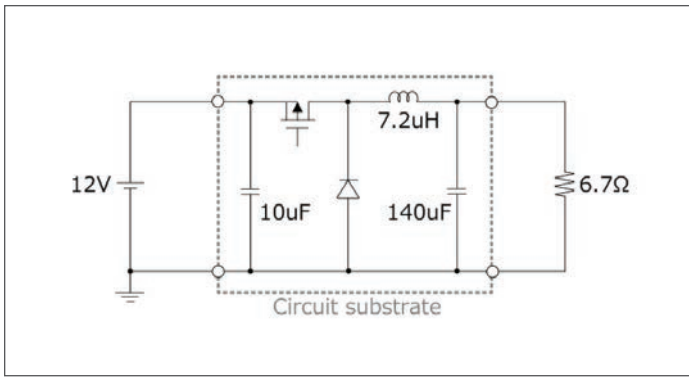

Figure 9: model of IC DC-DC step-down

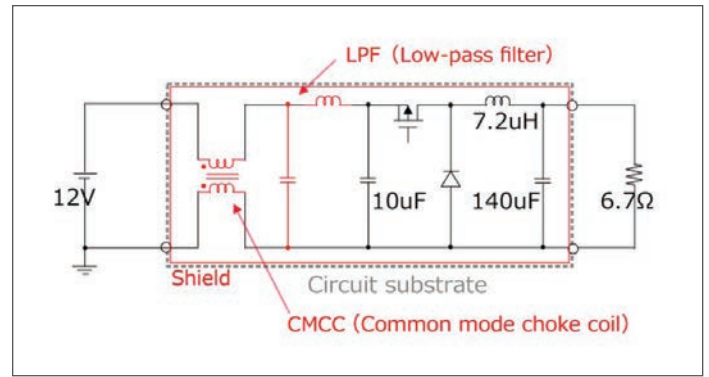

Figure 10: the circuit model of Figure 9 with noise suppression methods

Some methods consist of using appropriate shields to suppress noise up to 20 MHz. Or insert a common mode stop coil (CMCC) immediately next to the power connector to suppress noise in common mode at 20 MHz or higher, or, an LPF near the power connector to suppress noise in normal mode at 20 MHz or higher. In *Figure 10* an implementation circuit of what has been described.

CONCLUSION

Automobiles rely more on electronics: ADAS systems and self-driving vehicles; in all these there is a growing need to operate without errors without interfering with other systems in the vehicle. Through a selection of the appropriate components, materials and PCB study; engineers are able to design robust systems that enable automotive systems to operate EMI-free reliability.



IDENTIFYING AND LOCATING RADIO FREQUENCY INTERFERENCE (RFI)

Kenneth Wyatt

Principal Consultant, Wyatt Technical Services LLC
ken@emc-seminars.com

Introduction

With the plethora of wireless devices, increasing broadcast, communications, and other RF sources all competing for radio spectrum, the chances of radio frequency interference (RFI) will only increase. This article explains how to identify, characterize, and locate typical interfering sources.

CATEGORIES OF INTERFERENCE

There are two broad categories of interference; narrow band and broadband (Figure 1).

Narrow Band – this would include continuous wave (CW) or modulated CW signals. Examples might include clock harmonics from digital devices, co-channel transmissions, adjacent-channel transmissions, intermodulation products, etc. On a spectrum analyzer, this would appear to be narrow vertical lines or slightly wider modulated vertical bands associated with specific frequencies.

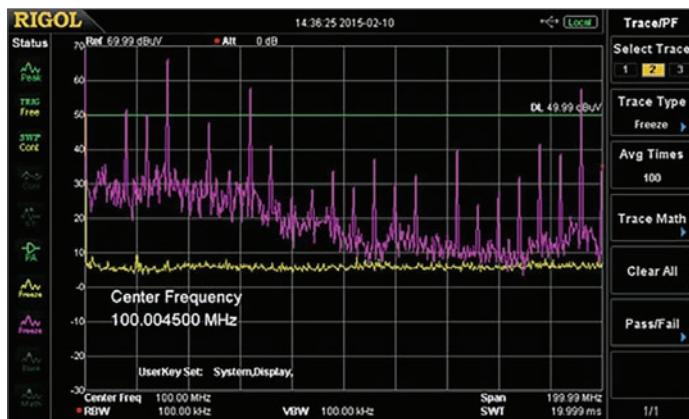

Figure 1. An example spectral plot from 9 kHz to 200 MHz of narrow band harmonics (vertical spikes) riding on top of broadband interference (broad area of increased noise floor). The yellow trace is the baseline system noise.

TYPES OF INTERFERENCE

Some of the most common types of interference are described below.

Co-Channel Interference – more than one transmitter (or digital harmonic) using, or falling into, the same receive channel.

Adjacent-Channel Interference – a transmitter operating on an adjacent frequency whose energy spills over into the desired receive channel.

Intermodulation-Based Interference – occurs when energy from two, or more, transmitters mix together to produce spurious frequencies that land in the desired receive channel. Third-order mixing products are the most common and usually, this occurs from nearby transmitters. An example of potential intermodulation might occur in a strong signal area for FM broadcast.

Fundamental Receiver Overload – this is normally caused by a strong, nearby, transmitter simply overloading the receiver front-end or other circuitry, causing interference or even suppression of the normal received signal. A common example is VHF paging transmitters interfering with receivers.

Power Line Noise (PLN) – This is a relatively common broadband interference problem that is typically caused by arcing on electric power lines and associated utility hardware. It sounds like a harsh raspy buzz in an AM receiver. The interference can extend from very low frequencies below the AM broadcast band, and depending on proximity to the source, into the HF spectrum. If close enough to the source, it can extend up through the UHF spectrum.

Switch-Mode Power Supplies – Switch-mode power supplies are very common and are used for a variety of consumer or commercial products and are a common source of broadband interference. Lighting devices, such as the newer LED-based lights or commercial agricultural “grow” lights, are another strong source of interference.

Other Transmitters – There are several transmitter types that commonly cause RFI:

- **Two-Way or Land Mobile Radio** – Strong interfering FM signals may result in “capture effect”, or over-riding of the desired received signal.
- **Paging Transmitters** – Paging transmitters are generally very powerful FM or digitally modulated transmissions that can overload receiver. Digital paging will sound very raspy, like a power saw or buzzing, and may interfere with a wide range

INTERFERENCE

of receive frequencies. Fortunately, most of the VHF paging transmitters moved to the 929/931 MHz frequency pairs, so this is not the issue it once was.

- **Broadcast Transmitters** – Broadcast transmitter interference will have modulation characteristics similar to their broadcasts – AM, FM, video carriers, or digital signals.

Cable Television – Signal leakage from cable television systems will generally occur on their prescribed channel assignments. Many of these channels overlap existing over-the-air radio communications channels. If the leaking signal is a digital channel, interference will be similar to wideband noise (a digital cable channel is almost 6 MHz wide).

Wireless Network Interference – Interference to wireless networks (Wi-Fi, Bluetooth, etc.) is increasingly common, and with the proliferation of mobile, household (IoT), and medical devices incorporating Wi-Fi and other wireless modes, this issue is likely to get worse. More details on wireless interference will be found in the companion article, *Wireless Network Interference and Optimization*.

LOCATING RFI

SIMPLE DIRECTION FINDING (DFING)

DF Techniques – There are two primary methods for DFing. (1) “Pan ‘N Scan” where you “pan” a directional antenna and “scan” for the interfering signal, recording the direction on a map, while keeping note of intersecting lines. (2) “Hot and Cold” where an omni-directional antenna is used while watching the signal strength. In this method, the rule of thumb is for every 6 dB change you’ve either doubled or halved the distance to the interfering source. For example, if the signal strength was -30 dBm at one mile from the source, traveling to within a half-mile should read about -24 dBm on the spectrum analyzer.

DF Systems – Radio direction-finding (RDFing) equipment can be installed into a vehicle or used portable. For vehicular use, there are several automated Doppler direction-finding systems available. Some examples include:

- Antenna Authority (mobile, fixed and portable)
www.antennaauthorityinc.com
- Doppler Systems (mobile and fixed)
www.dopsys.com
- Rohde & Schwarz (mobile, fixed, and portable)
<http://www.rohde-schwarz.com>

Step Attenuator – You’ll also find a step attenuator quite valuable during the process of DFing. This allows control over the signal strength indication (and receiver overload) as you approach the interference source. The best models come in steps of 10 dB and have a range of at least 80 dB, or more. Step attenuators may be purchased through electronics distributors, such as DigiKey, etc. Commercial sources would include Narda Microwave, Fairview Microwave, Arrow, and others.

LOCATING POWER LINE INTERFERENCE

For Low Frequency Interference – particularly power line noise (PLN) – the interference path can include radiation due to conducted emissions along power lines. Therefore, when using the

“Hot and Cold” method you’ll need to be mindful that the radiated noise will generally follow the route of the power lines, peaking and dipping along the route. The maximum peak usually indicates the actual noise source. As a complication, there may be several noise sources – some possibly long distances away.

Antennas – For simply listening to power line noise, the built-in “loopstick” antenna on an AM broadcast band radio or telescoping antenna on a shortwave radio may work well. However, for tracking down power line noise to the source pole, and typically for DFing other interfering sources, you’ll want to use higher frequencies. A simple directional Yagi, such as the Arrow II 146-4BP (*Figure 17*) with three piece boom (www.arrowantennas.com) can be assembled quickly and attached to a short length of pipe and works well to receive this type of broadband RFI.

Use of VHF Receivers – Whenever possible, you’ll generally want to use VHF or higher frequencies for DFing. The shorter wavelengths not only help in pinpointing the source, they also make smaller handheld antennas more practical.

Signature Analyzers – These are time-domain interference-locating instruments that produce a distinct “signature” of an interfering signal. This would include instruments produced by Radar Engineers (*Figure 2*). They are the best solution for tracking down power line noise and consumer devices that produce repetitive noise bursts with known periodicity.



Figure 2. A signature analyzer from Radar Engineers that tunes from 500 kHz to 1 GHz and which displays an electronic “signature” of a specific interference source. Receivers such as this are used by professional investigators to track down power line noise (photo courtesy, Radar Engineers).

LOCATING NARROW BAND INTERFERENCE

For most narrow band interference sources, such as co-channel, adjacent channel, and intermodulation interference, the recommended tool is the spectrum analyzer, as this allows you to focus on particular frequency channels or bands and see the big picture of what’s occurring. Once the interfering signal is identified, the analyzer can then be used to DF the signal.

USING SPECTRUM ANALYZERS

Spectrum analyzers display frequency versus amplitude of RF signals. They can be helpful in determining the type and frequencies of interfering signals, especially for narrow band interference. There are two types of analyzers; swept-tuned and real time.

INTERFERENCE

Swept-tuned analyzers are based on a superheterodyne principle using a tunable local oscillator and can display a desired bandwidth from start to stop frequencies. They are useful for displaying constant, or near constant, signals, but have trouble capturing brief intermittent signals, due to the lengthy sweep time.

A real-time analyzer samples a portion of the spectrum using digital signal processing techniques to analyze the captured spectrum. They are able to capture brief intermittent signals and are ideal for identifying and locating signals that may not even show up on swept analyzers.

Most real-time bandwidths are limited to 27 to 500 MHz, maximum. The Signal Hound BB60C and Tektronix RSA306 are both relatively inexpensive real-time spectrum analyzers that are USB-powered and use a PC for control and display.

One important point to keep in mind regarding the use of spectrum analyzers is that because they have an un-tuned front end, they are particularly susceptible to high-powered nearby transmitters off frequency from where you may be looking. This can create internal intermodulation products (spurious responses) or erroneous amplitude measurements that are very misleading. When using spectrum analyzers in an “RF rich” environment, it’s important to use bandpass filters or tuned cavities (duplexers, for example) at the frequency of interest.

Spectrum analyzers are also useful to characterize commercial broadcast, wireless, and land mobile communications systems. For wireless or intermittent interference, real-time analyzers work best. If used for tracking PLN, it’s best to place the analyzer in “zero-span” mode to observe the amplitude variation. Placing the analyzer in “Line Sync” may also be helpful.

COMMERCIAL INTERFERENCE HUNTING SYSTEMS

There are several manufacturers of interference hunting or direction-finding systems. I’d like to describe four of these, Aaronia, Narda, Rhode & Schwarz, and Tektronix.

As mentioned previously, for intermittent interference (particularly for commercial communications installations) or digitally-modulated signals, a real-time spectrum analyzer is the best tool and has the ability to capture brief, intermittent, signals; some as short as a few microseconds. Examples might include the Aaronia Spectran V5 series, Tektronix RSA-series, or Narda IDA2.

Aaronia – Aaronia not only has the lightest portable system for Dfing, but the biggest and heaviest-looking. Their Spectran V5 Handheld is the smallest real time analyzer. Mapping is not an option on this model, but the larger Spectran V5 XFR PRO is a ruggedized laptop that can use open-source maps and has triangulation features. Aaronia also has a variety of affordable directional antennas and a combination GPS/compass may be mounted on some models.

Aaronia is also unique in that they’ve developed a drone detection system comprised of a 3D tracking antenna, the model IsoLOG 3D with options from 9 kHz to 40 GHz in 360 degrees. This matches up with their Spectran Command Center with triple LCD screens. See the references for more information on that system.



Figure 3. The Aaronia Spectran V5 handheld real-time analyzer is the smallest self-contained unit and tunes from 9 kHz to 6 GHz. Other models have upper frequencies of 12 and 18 GHz.



Figure 4. The Aaronia Spectran V5 XFR PRO in the field portable configuration.



Figure 5. The Narda IDA2 spectrum analyzer and interference hunting system. The frequency range is 9 kHz to 6 GHz. Photo courtesy, Narda STS.

Narda Safety Test Solutions – Narda has a similar interference analyzer, the Model IDA2 with a real-time bandwidth of 32 MHz and frequency range of 9 kHz to 6 GHz. There are a variety of directional antennas available with built-in GPS and compass. This system also relies on open-source mapping tools, such as Open Street Maps (<http://www.openstreetmaps.org>). It is battery-operated for easy portable use.

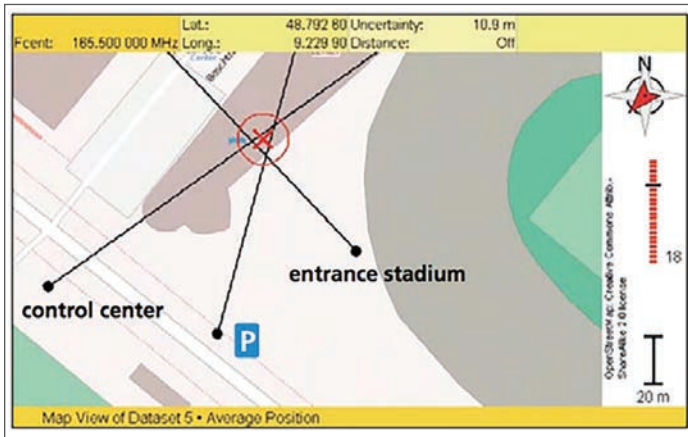

Figure 6. The mapping software with bearing lines drawn showing triangulation of an interference source. Photo courtesy, Narda STS.

Rohde & Schwarz – Rohde & Schwarz has a portable system (Figure 7) that can quickly identify most interference sources and can also use imported mapping feature and GPS/compass in the antenna to triangulate the interfering source. Several fixed, mobile, or portable antennas are available for different frequency bands. This system also relies on open-source mapping tools, such as Open Street Maps (<http://www.openstreetmaps.org>). It is battery-operated for easy portable use.



Figure 7. The Rohde & Schwarz R&S®PR100 custom spectrum analyzer with mapping and triangulation and R&S®HE300 antenna. The R&S® FSH analyzer may also be used. Photo courtesy, Rohde & Schwarz.

Tektronix – Tektronix also has a means of Dfing and mapping with their real time DSA-series spectrum analyzers. The USB-controlled RSA507A is noteworthy due to its built-in battery and portable capability. It also offers 40 MHz real-time bandwidth. By connecting it to a tablet PC, such as the Panasonic Toughpad model FG-Z1 and with the Alaris DR-A0047 antenna, you have a self-contained portable DF hunting tool (Figure 9). This system also

relies on open-source mapping tools, such as Open Street Maps (<http://www.openstreetmaps.org>).

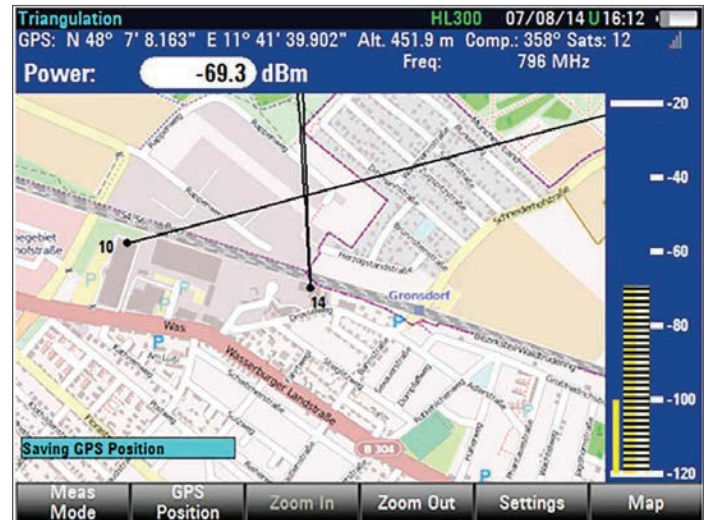

Figure 8. The mapping application for the R&S® FSH analyzer. Photo courtesy, Rohde & Schwarz



Figure 9. The Tektronix spectrum analyzer with mapping/triangulation and Alaris DR-A0047 antenna. Photo courtesy, Tektronix.

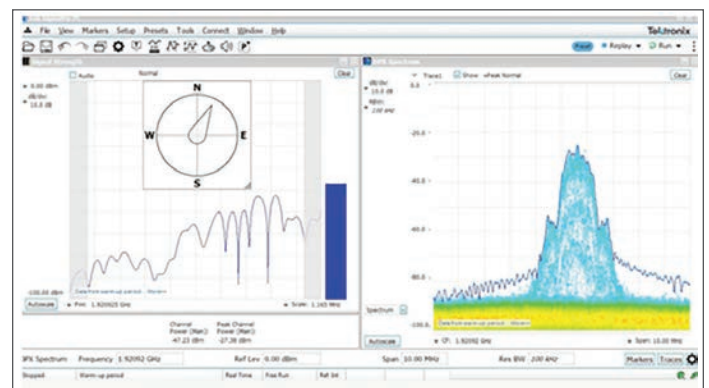

Figure 10. When the SignalVu-PC software with mapping option is connected to one of their RSA-series real time spectrum analyzers and Alaris directional antenna, the compass direction is automatically shown, along with the spectral display of the signal in question. Photo courtesy, Tektronix.

Tektronix provides their SignalVu-PC with Mapping option to help identify and capture interfering signals. The mapping option allows bearing lines to be marked on the map to triangulate the source of interference.

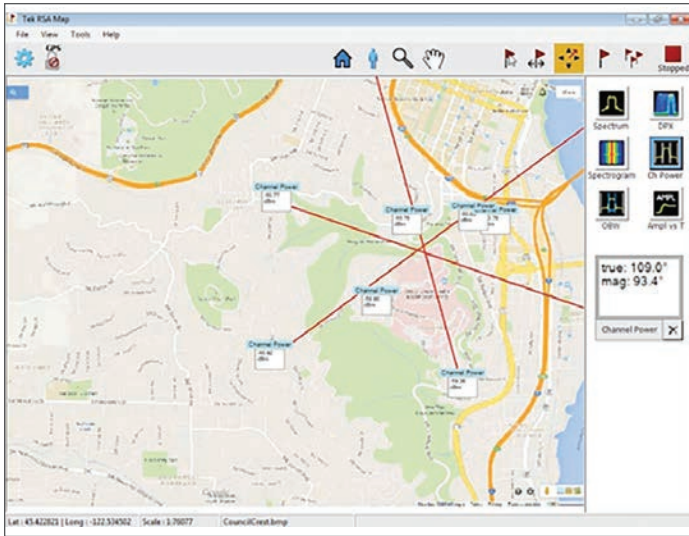

Figure 11. Flipping over to the mapping option of SignalVu-PC, allows you to record bearing lines to the interfering source, with the triangulation showing the approximate location of the source. Photo courtesy, Tektronix.

SUMMARY

With today's increasing use of wireless devices, broadcast, communications, military and other RF sources all competing for radio spectrum, the chances of radio frequency interference (RFI) will only increase. With the proper tools, broadcast and communica-

tions engineers are able to quickly identify and eliminate sources of interference as they are detected. The latest real-time spectrum analyzers make the job even more efficient.

MANUFACTURERS MENTIONED

- **Aaronia AG** | www.aaronia.com
- **Narda Safety Test Solutions** | www.narda-sts.com/en/
- **Radar Engineers** | www.radarengineers.com
- **Rohde & Schwarz** | www.rohde-schwarz.com/us/home_48230.html
- **Tektronix** | www.tek.com

REFERENCES

- Handheld Interference Hunting (R&S video)
- Automated Interference Hunting in Multipath Environments (R&S video)
- Advanced Interference Hunting and Emitter Location (R&S)
- Interference Hunting with R&S'FSH (R&S)
- Locating A Signal Source (R&S)
- Interference Hunting (Tektronix)
- Hunting Interference with the Tektronix RF Scout (Tektronix)
- Finding, Classifying, and Analyzing Interfering Signals (Tektronix)
- Clock Radio Disrupts VHF Reception (Narda STS)
- Analysis of Jamming Systems for Mobile Phone (Narda STS)
- Drone Detection System (Aaronia)



EMISSIONS TEST FACILITY – OATS VS SAC?

Ghery Pettit

President, Pettit EMC Consulting LLC

Ghery@PettitEMCConsulting.com

Introduction

You've been tasked by management to build a new, from scratch, EMC test facility. Among other items, you need to decide between an Open Area Test Site (OATS) or an RF Semi-Anechoic Chamber (SAC). How do you decide? To someone who has been there, done that, the choice is clear, but what are some factors that might sway the decision one way or the other?

DESIGN OF AN OATS

An OATS is defined in the standards basically as a large area, free of objects above the ground that might reflect RF energy. The standards go on to generally require a metallic ground plane and the minimum clear area. This clear area is stated as an elliptical area whose major axis is twice the measurement distance and whose minor axis is the square root of 3 times the measurement distance. A pure OATS would not have a weather protective cover over the EUT or the whole site.

DESIGN OF A SAC

In simple terms, a SAC is an RF shielded box lined on the walls and ceiling with RF absorbing material to simulate an ambient free OATS. In the past the design of a good SAC was as much art as it was science and many different designs were tried as engineers aimed for specifying a chamber that would meet the same requirements as an OATS while not breaking their employer's bank. Today chamber manufacturers have much better absorbing material to work with and once they are consulted on the size requirements the design work for the customer becomes one of laying out the facility in a manner to allow convenient testing of the products envisioned.

WHAT ARE SOME OF THE CONSIDERATIONS AND "GOTCHAS" IN AN OATS?

While the concept of an OATS is fairly simple, the details make them a bit more complicated.

First, and foremost, the OATS must be built in a location that satisfies seemingly conflicting requirements. The OATS should ideally be built in a location that is convenient for the company. Travel distances and times between the development facility and the OATS should be kept to a minimum to avoid non-productive time for personnel and hardware moving between the sites.

The OATS must be built in a place that have minimal, if any, ambient RF signals. This means that it should be built in a location where radio (especially FM broadcast) and television reception is terrible. Otherwise, the operator at the OATS will have to identify every signal received and decide if it is from the EUT or is an am-

bient signal. And if this is the only emissions test facility available there is the distinct possibility (seen by the author) of missing an emission entirely because it is buried by a local radio or TV station.

The minimum dimensions for the clear area ellipse have been shown by a number of engineers over the years to be inadequate. Engineers at HP in Cupertino, CA determined that these dimensions should be doubled and further investigation by an engineer at Intel Corporation in DuPont, WA showed that even with doubling the dimensions it was necessary to take further mitigating actions to meet NSA requirements. For a 10 meter OATS (10 meters being the measurement distance) this requires a large area of ground, ideally remotely located. The author built what might be the ultimate OATS nearly 30 years ago when he built a 30 meter OATS with a double sized clear area ellipse and then wound up only using it at 10 meters. Clearly overkill by accident, but it eliminated any problems with reflecting objects above the ground. The site did, however, have other challenges.

WHAT ARE SOME OF THE CONSIDERATIONS AND "GOTCHAS" IN A SAC?

The first consideration is financial. Will the company commit to paying the cost of a SAC? A 10 meter SAC is a major facility and is not cheap. Prices have been as low as about \$1,000,000 and have gone significantly higher, depending on size and features desired.

Once you get past the cost issue, what are some other considerations?

Where will the SAC be located? Does the company already have a facility where the chamber will fit? Is the ceiling high enough? Or is the company building a new facility where the chamber will be located? Is there enough space for the chamber, control room (or desk) and preparation area for test samples? How about storage space for test equipment and test samples? How will the facility be laid out, both for operational and convenience considerations? If the SAC is going in an existing building are there adequate facilities for it? Power, air conditioning, compressed air? If you are marketing your product internationally, how will you provide power at frequencies and voltages not normally seen in the location where the lab is being built?

OATS VS SAC

Let's take a look at some advantages and disadvantages of an OATS vs a SAC.

An OATS is a fairly simple facility, in principle, to design and build. There are a number of details that one learns by trial and error, but the basics are simple. It has the advantage over a SAC in that it is less expensive to build. I didn't say "cheap", I said less expensive. OATS facilities can be built for a few hundred thousand dollars plus the cost of the land. They can be significantly more expensive, depending on the size, how the ground plane is constructed and how the EUT or even the site is to be weather protected. Land is a major cost factor in any metropolitan area. "Less expensive" always appeals to bean counters regardless of other factors.

On the other hand, an OATS should be built in a location where the RF ambient is minimal. This should preclude locating an OATS in a metropolitan area as there are numerous radio and TV stations and other radio services in operation. Over the years the author has seen OATS facilities that were even built on the roof of a building. The "land" was cheap, but you had to ask what made any difference between putting a TV antenna on top of a mast on the roof (these were the days when cable wasn't as ubiquitous as it is today) and putting an OATS on a roof. Not the best place to put a test facility where a low ambient was needed. In any case, the low ambient requirement generally requires placing the OATS well outside a metropolitan area and raises the operating costs due to travel time to get to/from the site. And, while this requirement may be met by a given location at the time construction is commenced, the author has seen excellent OATS locations rendered unusable over time due to increasing RF ambient signals, resulting in the abandonment of the facility after a number of years.

While the design of an OATS seems simple, the author has experienced problems relating to building it "too well". That 30 meter OATS referred to earlier had its ground plane on a concrete slab, shot in with a laser level. Very flat. A great idea, but even in California it does rain and a perfectly level concrete slab doesn't drain very well, resulting in water getting in to underground fixtures like cable connection boxes and the like. When he built OATS facilities in the northwest (where it is known to rain a lot) the ground planes were on wood decks, where drainage wasn't an issue. Be aware of propagation velocity differences between different materials that may be used to construct a cover over the EUT. Have a uniform design in the wall between the EUT and the antenna, or else unexpected results may be found. Ask the author over a beer about this matter sometime, it is educational.

An OATS requires periodic maintenance to prevent operational problems. Haul ropes and guy ropes for antenna masts must be inspected or replaced periodically as they deteriorate due to the UV in the sun's rays. Allowed to progress too far and this deterioration can result in antenna damage (the voice of experience here). Oh, and what happens when lightning strikes an antenna mast? It has happened.

Comparing an OATS and its issues with a SAC, the SAC has the following advantages and disadvantage (a major one).

A SAC can be built anywhere you have the space for it. Due to

its design it is impervious to interference from local radio and television broadcast stations. Even an amateur radio station with a (legal) 1500 Watt amplifier and a nice beam antenna across the street from the chamber is not an issue. A SAC must be properly designed and built, but today this isn't a major difficulty. Weather protection isn't an issue as the SAC is built indoors.

Conveniently locating a SAC minimizes the time and cost associated with personnel traveling to/from the lab. It may even be located down the hall from the development group, making it very convenient for all testing from initial experiments to final qualification testing.

Periodic maintenance of antenna mast mechanisms is greatly reduced, as is the need for guy ropes. There aren't any winds inside a chamber to deal with, unlike at an OATS. There still are things that should be checked and cleaned, but they are not needed as often. You do need to protect absorber material from curious people who are unaware of the damage they can cause just by squeezing the material to see what it feels like. You might consider mounting a sample outside the chamber where they can satisfy their curiosity without causing harm to the working material.

The major disadvantage of a SAC compared to an OATS is cost. An OATS can be built for significantly less initial outlay of cash than a SAC. Over time, however, a SAC is a far better choice. Yes, the author is showing his bias.

CONCLUSION

The author freely admits his bias in favor of a 10 meter RF semi-anechoic chamber over an OATS. It comes from decades of experience with both types of facilities. A SAC can be built in a location far more convenient for the company. It takes far less space than an OATS and typically requires less ongoing maintenance. It does not suffer from existing or future RF ambient signals. While initially more expensive to build (neglecting land acquisition costs) it can be less expensive over the life of the facility due to reduced travel and maintenance expenses. The choice is left to the reader (and his company), but you have to ask yourself why so few new OATS facilities are being built, while chamber manufacturers stay in business.

Keep in mind, as well, that standards change over time. Whichever way you go (OATS or SAC) it is always nice to be clairvoyant and design the facility so that if modifications become necessary they can be incorporated in the future without having to build a new facility from scratch. Yes, the standards committees do try to avoid such things, but sometimes a seemingly innocuous change can have a significant impact on lab design. Leave yourself some wiggle room.

WHAT YOU SEE WITH NEAR FIELD PROBES

Arturo Mediano

Owner, HF-Magic Lab® and Professor at University of Zaragoza
a.mediano@ieee.org

In EMI/EMC troubleshooting, near field probes (NFPs) are great tools. Let's review how to understand what you really see at the screen of your instrument with a magnetic near field probe.

EMI/EMC problems (radiated and conducted emissions) are usually related with current in your circuits: high frequency currents (i.e. high di/dt currents) are responsible of radiation from PCBs, cables, slots and apertures, ground noise, crosstalk, etc.

That is because a magnetic field probe (loop) is a great help to identify where the culprit signal is being created (ringing, parasitic oscillations, harmonics, etc.). And it is common to use near field probes with spectrum analyzers. In this way, you see the spectrum of the signals close to the probe and it is easy to measure the frequencies involved in the test. Sometimes no more info is needed.

But, have you ever thought about what you have in the screen of your instrument? Is magnetic field? Is current in your circuit? Is voltage in your circuit? ... Think. Near field probes give us a voltage applied to the input impedance of the instrument (50 ohm or 1 Mohm, typ.) so, what is exactly that voltage?

I will try to explain the idea with a very basic experiment as in Fig. 1.

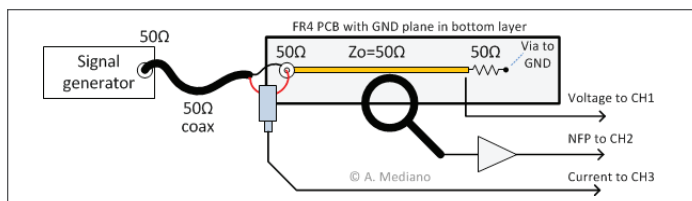

Fig. 1. The setup of our experiment.

The signal from a signal generator with 50 ohm output impedance is applied to a 50 ohm trace in a two layer PCB. The line is terminated with 50 ohms.

A square wave signal with 20 MHz frequency is applied to the circuit with our signal generator and our magnetic near field (ROUND) probe is located close to the signal and connected to channel 2 of the oscilloscope (Agilent InfiniVision DSO 7104B) using a low noise and linear amplifier.

The FFT of the signal (or you can use your spectrum analyzer) is observed in the screen in channel 2, CH2 (Fig. 2):

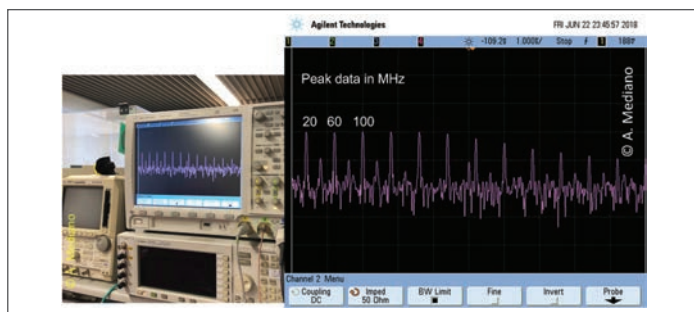

Fig. 2. The frequency domain for the output of our near field probe.

What we see on the screen is the FFT of a VOLTAGE (the output voltage of the near field probe on the input impedance of the scope). How is that voltage related with currents and voltages in the circuit?

Remember with the probe we capture magnetic field lines (the probe is shielded for electric fields) and we can identify the harmonics of our 20 MHz “clock”. Note odd harmonics are bigger than even harmonics.

Let us add two additional probes to our experiment: the voltage in the load resistor will be measured in channel 1 (CH1) with a passive (x10) probe and the current in the circuit will be measured in channel 3 (CH3) as explained in Fig. 1 and in Fig. 3:

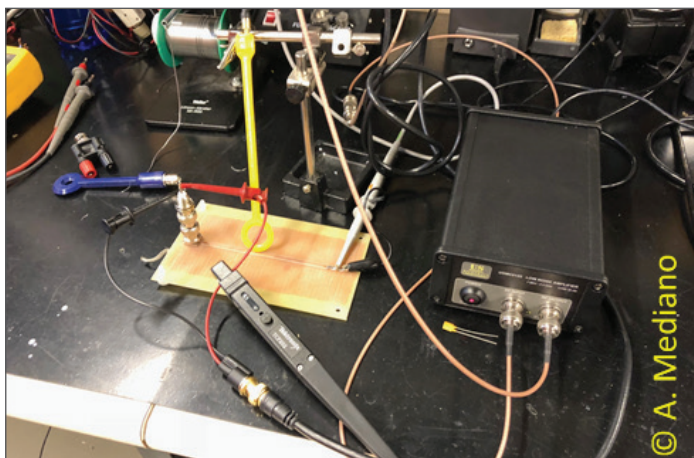

Fig. 3. Detail of the experiment.

EMC TEST

In Fig. 3 you can see the PCB board, the near field probe (from Bee-hive), the Tektronix TCP202 current probe, and my US Microwave Laboratories USMC0125 Low Noise Amplifier (a really useful tool for any EMI/RF lab).

We configure the output of the signal generator to SINUSOIDAL waveform (20 MHz frequency). In Fig. 4 we see the screen of our instrument.

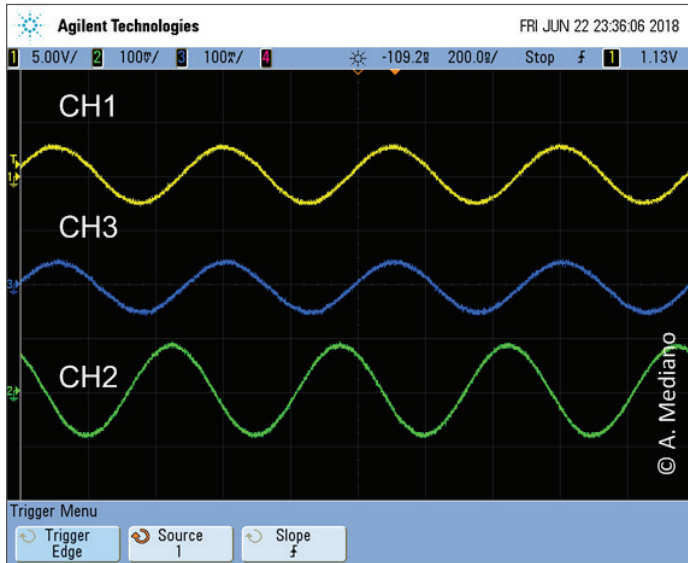

Fig. 4. Measurements for the second experiment: voltage in load resistor (CH1), current in the circuit (CH3), and near field probe output (CH2).

Note CH1 and CH3 are in phase (resistive load for the signal generator).

If you see CH2 in spectrum analyzer, FFT or time domain (without seeing CH1/CH3) perhaps you will not appreciate that CH2 and CH3 are related but they are not the same signal. The near field probe is measuring magnetic field so the output voltage is proportional to magnetic field. You can see that CH3 and CH2 are 90° approx. in phase difference.

Sometimes in the spectrum point of view this is not a problem if you are interested in measuring the frequency (i.e. measuring some ringing) but in other situations while troubleshooting serious problems is important to consider the difference.

Now, change the output of the signal generator to SQUARE waveform again (20 MHz frequency). In Fig. 5 we see the screen of our instrument.

Now, the waveform is changed to square and you can appreciate CH3 and CH2 are fully different.

The reason for this behavior is the near field probe close to your circuit trace (or wire) is picking-up magnetic field lines and we can represent the coupling effect like a transformer with a primary (your circuit with current i) and a secondary (the near field probe). The output of the secondary is exactly $M \cdot di/dt$ (where M is mutual inductance or coupling factor between the circuits) so, it is proportional to the derivative of current in your circuit!

Again with Fig. 5 we see clearly that the output of the near field probe (CH2) is proportional to di/dt (blue trace in CH3).

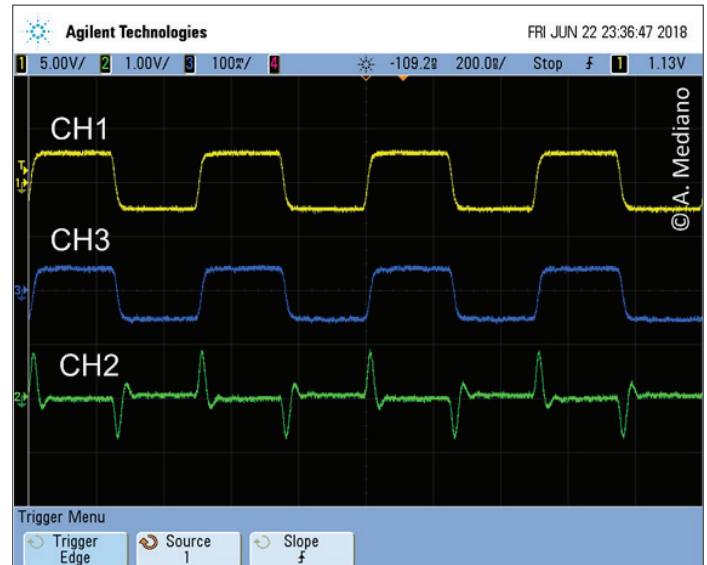

Fig. 5. Signals with square waveform in signal generator.

If you rotate the near field probe 180° the screen changes as in Fig. 6.

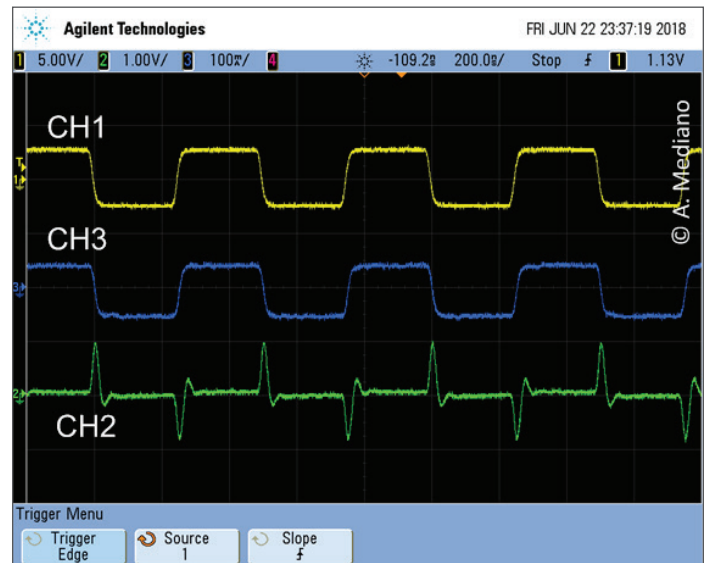

Fig. 6. Signals with square waveform in signal generator rotating the near field probe 180°.

Another interesting plot is the FFT for the current probe and for the NFP output for comparison (Fig. 7).

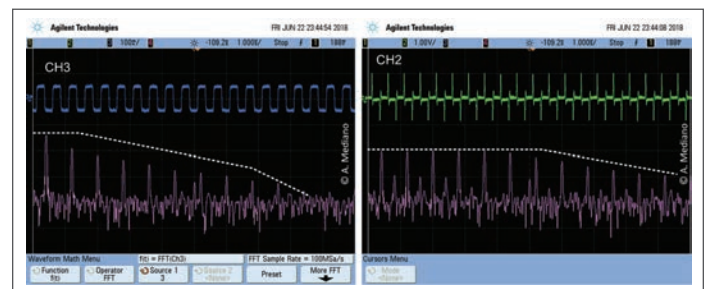

Fig. 7. The spectrum of current (CH3) and near field probes (CH2).

EMC TEST

The spectrum of CH3 is the spectrum of a square wave signal, reducing harmonic amplitudes at -20 dB/decade and -40 dB/decade.

For the NFP (CH2) the low frequency components are with constant amplitude up to medium frequencies because the very small duty cycle of the waveform (remember the comb generator signals or the spectrum of impulsive signals).

So, remember: when using a ROUND magnetic near field probe, you will see in the screen of your instrument the time or frequency domain of the derivative of the current in your circuit.

Tip: with lower frequencies perhaps you can integrate with your scope to see the current in your screen.

ABOUT THE AUTHOR

Arturo Mediano received his M.Sc. (1990) and his PhD. (1997) in Electrical Engineering from University of Zaragoza (Spain), where

he has held a teaching professorship in EMI/EMC/RF/SI from 1992. From 1990, he has been involved in R&D projects in EMI/EMC/SI/RF fields for communications, industry and scientific/medical applications with a solid experience in training, consultancy and troubleshooting for companies in Spain, USA, Switzerland, France, UK, Italy, Belgium, Germany, Canada, The Netherlands, Portugal, and Singapore.

He is the founder of The HF-Magic Lab®, a specialized laboratory for design, diagnostic, troubleshooting, and training in the EMI/EMC/SI and RF fields at I3A (University of Zaragoza), and from 2011, he is an instructor for Besser Associates (CA, USA) offering public and on site courses in EMI/EMC/SI/RF subjects through the USA, especially in Silicon Valley/San Francisco Bay Area. He is Senior Member of the IEEE, active member from 1999 (Chair 2013-2016) of the MTT-17 (HF/VHF/UHF) Technical Committee of the Microwave Theory and Techniques Society and member of the Electromagnetic Compatibility Society.

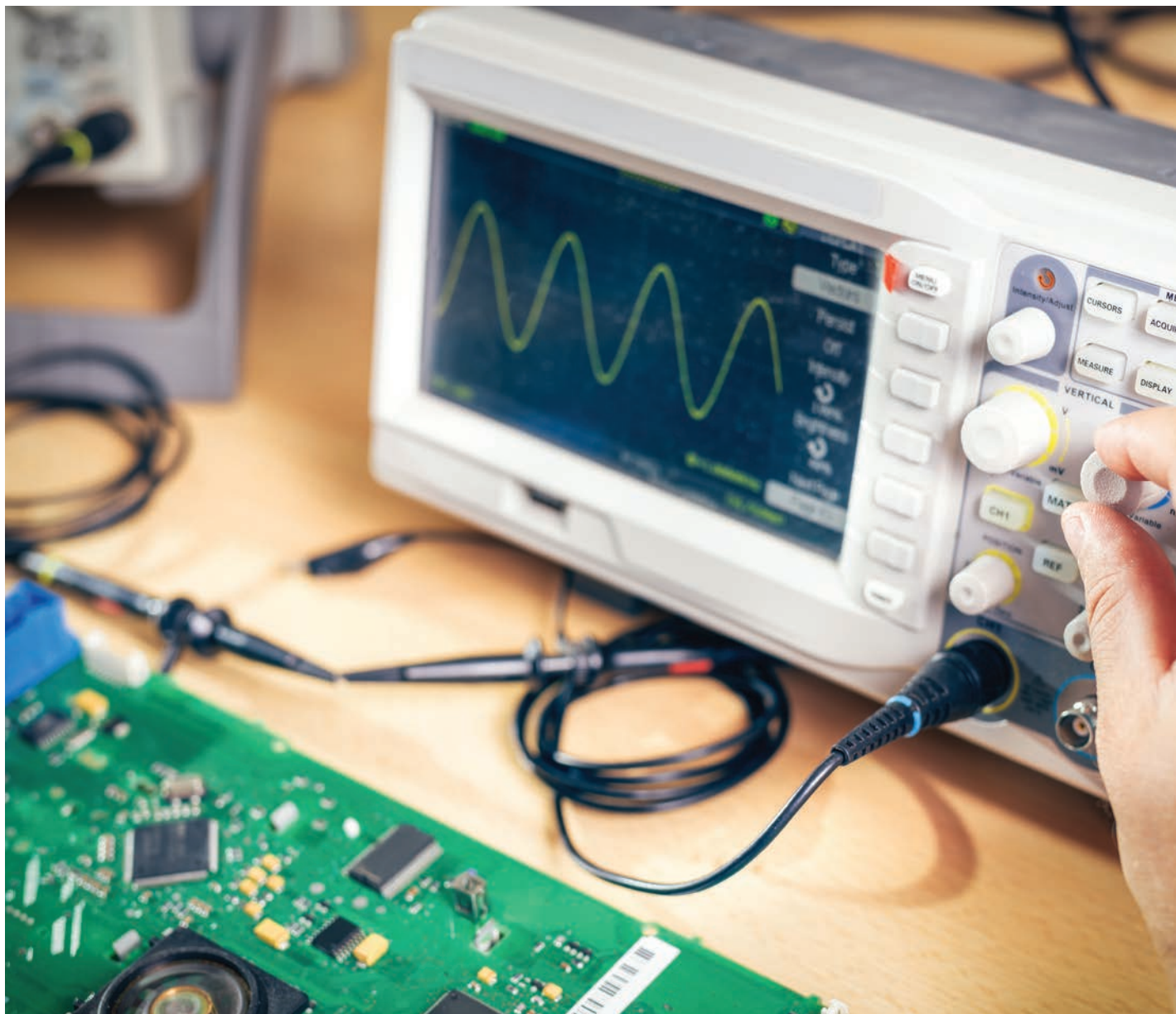

EMI TROUBLESHOOTING WITH REAL-TIME SPECTRUM ANALYZERS

Kenneth Wyatt

Principal Consultant, Wyatt Technical Services LLC
ken@emc-seminars.com

Introduction

The latest tool for serious EMI troubleshooting or debugging has become the real-time (RT) spectrum analyzer. Because manufacturing costs have been decreasing, some RT analyzers are becoming more affordable than ever. In this article, I'll show you the advantages in using RT analysis for observing and troubleshooting unusual EMI.

INTRODUCTION

First, let's review the differences between the conventional swept and real-time spectrum analyzers.

Swept-Tuned Analyzer – The swept analyzer uses a tunable local oscillator in a standard superhetrodyne circuit. It can sweep over a specified frequency range and using a user-selected resolution (or “receiver”) bandwidth. RF signals introduced to the input port are mixed with the local oscillator and the specified frequency span is display as RF power versus frequency. The only time data is captured is during the sweep time. After the frequency sweep, the captured data is processed and displayed. There is usually significant delay (or “dead” time) between sweeps, so its quite possible for the analyzer to miss capturing intermittent or fast-moving signals.

Real-Time Analyzer – A real-time analyzer uses a stationary LO, looks at narrow windows of bandwidth (real-time bandwidth), and digitizes the incoming spectrum. This digitized spectrum is stored in a time record buffer and held for processing by the FFT algorithm. Ideally, once digitized, FPGAs process FFTs at a rate equal, or faster, than the collection rate. However, this collection rate depends on the span and resolution bandwidth. The major difference between the swept-tuned analyzer and real-time analyzer is the sheer number-crunching ability of the real-time calculation, as well as a fast graphics processor, which allows for a data-dense display of various frequency-versus-time presentations and digital demodulation.

The advantages of a RT analyzer is the ability to capture RF pulses as short as 20 us, digital modulations, and other pulsing or fast changing signals. In addition, they can capture and process data much faster than swept analyzers – there's no need to wait seconds or minutes to capture a spectrum. This allows very fast troubleshooting, since you can see the result of fixes immediately.

Finally, the RT analyzers have an addition feature called a spec-

trogram (or “waterfall”) display, where signals are shown versus time. This is a great feature allowing you to determine the timing of intermittent EMI.

I'll be using the Tektronix RSA306B (*Reference 1*) real-time USB-controlled spectrum analyzer with Tekbox Digital Solutions (*Reference 2*) near field probes for this article, but there are many other choices available.

Figure 1 shows a typical advantage of the RT display over that of the swept display. Here, we see some broadband motor noise completely masking several narrow band harmonics. The swept analyzer has trouble capturing the motor noise, but we can see occasional captures indicating there was “something” there. Max Hold mode and waiting a while will help fill in the swept display, but then you'd miss seeing the narrow band emissions.

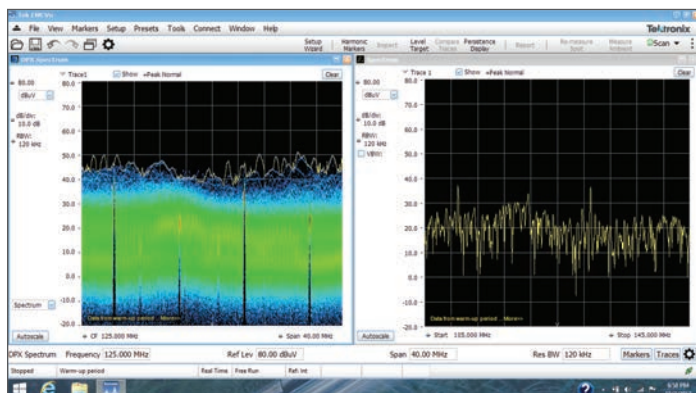

Figure 1 – An example where the broadband emissions from a motor controller completely mask a series of narrow band harmonics. You can see on the right that the standard swept analyzer has trouble capturing this broadband noise.

Most RT analyzers will also have optional EMI software that will help collect data or even perform pre-compliance testing for radiated and conducted emissions. For example, Tektronix offers

EMC TEST

their SignalVu-PC software with the RSA306B, but also recently announced their EMI troubleshooting and pre-compliance software for the RSA-series, called “EMCVu”. EMCVu includes some impressive EMI troubleshooting and pre-compliance test features and can switch from one mode to the other quickly. It comes with pre-defined transducer factors (antenna and cable loss tables), CISPR and FCC limit lines, and easy report generation. In pre-compliance mode, it can scan the entire frequency range in a few seconds, numbering all the harmonics above the limit and within a certain margin to the limit. These captured harmonic signals can then be examined more closely and then switched over to troubleshooting mode to try various fixes.

Either SignalVu-PC or EMCVu will work fine for basic troubleshooting or debugging emission issues and I’ve actually used both for this article. If you also want pre-compliance test capability in-house (a wise decision) or more advanced troubleshooting tools, then you’ll want to invest in EMCVu.

THREE-STEP PROCESS FOR EMI TROUBLESHOOTING

I’ve developed a three-step process for EMI troubleshooting, which I’ll briefly explain below. We’ll use Tektronix’ SignalVu-PC or EMCVu as an example, but several other companies sell similar compliance software. You’ll want to download the free “2017 EMI Pre-Compliance Test Guide” from Interference Technology for more details on this troubleshooting process (*Reference 3*).

Step 1 – Use near field probes (either H- or E-field) to identify energy sources and characteristic emission profiles on the PC board and internal cables. Energy sources generally include clock oscillators, processors, RAM, D/A or A/D converters, DC-DC converters, and other sources, which produce fast-edged digital signals. If the product includes a shielded enclosure, probe for leaky seams of other apertures. Record the emission profile of each energy source.

Step 2 – Use a current probe to measure high frequency cable currents. Remember, cables are the most likely structure to radiate RF energy. Move the probe back and forth along the cable to maximize the highest currents. Record the emission profile of each cable.

Step 3 – Use a nearby antenna (I use a 1m test distance) to determine which of the harmonic content actually radiates. Catalog these harmonics and compare to the internal and cable measurements. This will help you determine the most likely energy sources that are coupling to cables or seams and radiating.

ANALYZE THE DATA

Remember that not all near field signals will couple to “antenna-like” structures and radiate. Use a harmonic analyzer tool (see *Reference 4*) to help identify harmonics belong to specific energy sources. Note that in many cases, two, or more, sources will generate the some (or all) the same harmonics. For example, a 25 MHz clock and 100 MHz clock can both produce harmonics of 100, 200, 300 MHz, etc. Oftentimes, you’ll need to fix more than one source to eliminate a single harmonic. EMCVu includes some powerful data capture and documentation features that will help speed up the data collection process from steps 1 through 3.

After the harmonics are analyzed and you have identified the most

likely sources, the next step is to determine the coupling path from source and out the product. Usually, it’s the I/O or power cables that are the actual radiating structure. Sometimes, its leaky seams or apertures (display or keyboard, for example).

There are four possible coupling paths; conducted, radiated, capacitive, and inductive. The latter two (capacitive and inductive) are so-called; “near field” coupling and small changes in distance between source and victim should create large effects in radiated energy. For example, a ribbon cable routed too close to a power supply heat sink (capacitive coupling or dV/dt) and causing radiated emissions can be resolved merely by moving the ribbon cable further away from the heat sink. The inductive coupling (di/dt) between a source and victim cable can also be reduced by rerouting. Both these internal coupling mechanisms (or similar PC board design issues) can lead to conducted (out power cables) or radiated (I/O or power cables acting as antennas, or enclosure seams/apertures) emissions.

In many cases, its simply poor cable shield bonding to shielded enclosures or lack of common-mode filtering at I/O or power ports that lead to radiated emissions.

HOW CAN RT ANALYZERS HELP TROUBLESHOOT EMI?

So, let’s turn our attention back to probing the PC board and cables. How often have you probed, troubleshot, and fixed a product only to have it fail at the compliance test facility? Many of today’s products, especially mobile products, include on board DC-DC converters that produce a very broadband EMI spectrum out past 1 GHz that can impact the operation of cellular or GPS wireless receivers. In addition, digital processors can change emission characteristics with time or operating mode. Add wireless features and you have a myriad of potential energy sources that can change emission characteristics with time.

I’d like to demonstrate a some examples where swept analyzers might very well miss a bursting increase in emissions or fail to capture broadband EMI that is greater in amplitude than the usual narrow band harmonics we’re all used to.

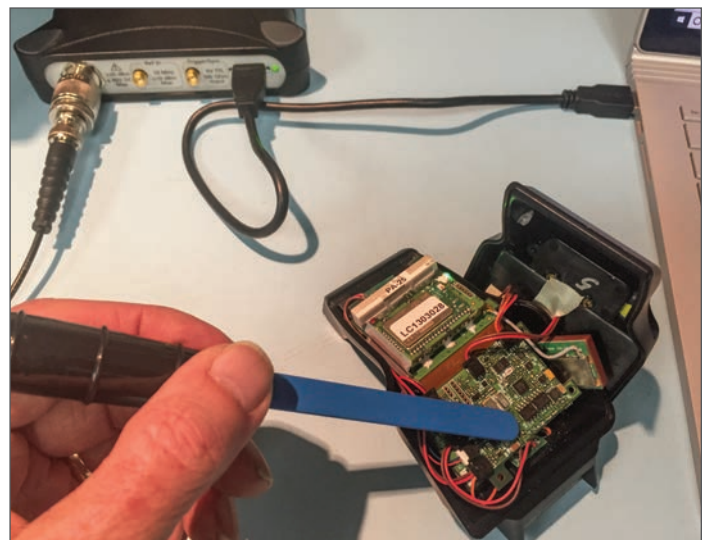

Figure 2 – Using a near field (H-field) probe on an on-board DC-DC converter in a small mobile device. I’m using the Tektronix RSA306B USB-controlled RT spectrum analyzer and Tekbox near field probe.

EMC TEST

EXAMPLE 1 - PULSATING HARMONIC EMI

Most of the time, you'll find narrow band harmonics are relatively stable in amplitude. However, there are times when the amplitude can change, due to gated digital signals or different operating modes. If the harmonic peaks upward at the wrong time, it can lead to compliance failures.

Swept analyzers can easily miss these infrequent amplitude peaks. Placing the swept analyzer in "Max Hold" mode can help, but it could take several minutes to capture the peak of the emission. Even so, peaks can be missed, due to dead time in between scans.

RT analyzers, on the other hand are adept at capturing fast changing signals. Here's an example where I was measuring the narrow band low frequency emissions from an on-board DC-DC converter on a small mobile device (*Figure 2*).

In *Figure 3*, we're looking from 9 kHz to 10 MHz and we see the swept measurement is even having a hard time capturing the regular peak emissions, while the RT measurement captures the peaks easily and even detects an occasional six dB pulsing increase in amplitude (as shown in the blue persistence display).

That infrequent pulsing amplitude increase could easily cause a compliance failure should it couple out through conduction or radiation.

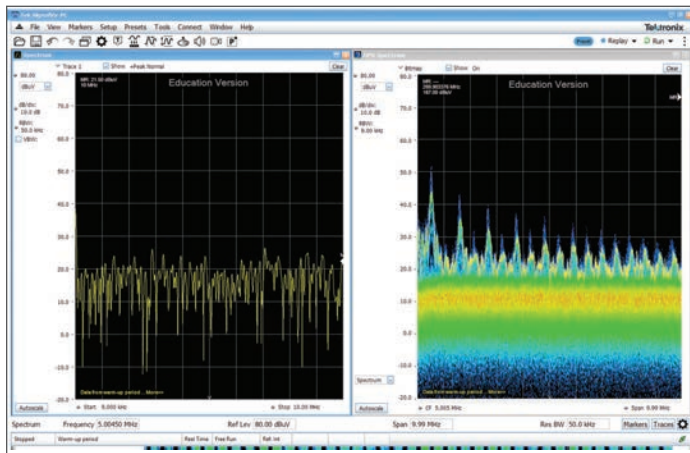

Figure 3 - Measuring the emissions from an on-board DC-DC converter and comparing swept (left) and real-time (right). Note the 6 dB peaks in the blue persistence display.

EXAMPLE 2 - IDENTIFICATION OF EMISSIONS DUE TO DIFFERENT OPERATING MODES

In this example, we're measuring that same DC-DC converter (*Figure 1*), but looking from 105 to 145 MHz, a frequent area of compliance failures due to radiated emissions.

The surprising result was the three very different spectral responses, due to different operating modes of the mobile device.

In some cases, the emission was about 25 dB higher than the swept measurement could capture.

Now, would you be willing to take the risk that the swept measurement at the compliance test facility would either miss or manage to capture this should it couple out and radiate?

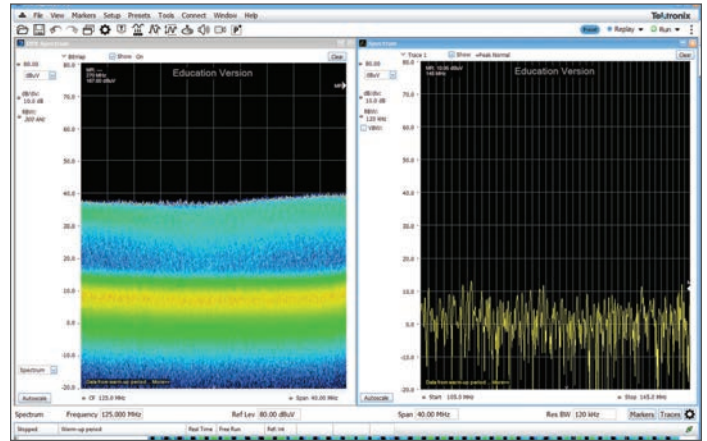

Figure 4 - Broadband emissions from the DC-DC converter looking from 105 to 145 MHz. The swept measurement on the right was unable to successfully capture this, except for an occasional burst. Max Hold mode would have helped, but would have taken at least a minute to "fill in" the display. But once the display was filled in, you may not have been able to see the following two very different modes in Figures 5 and 6.

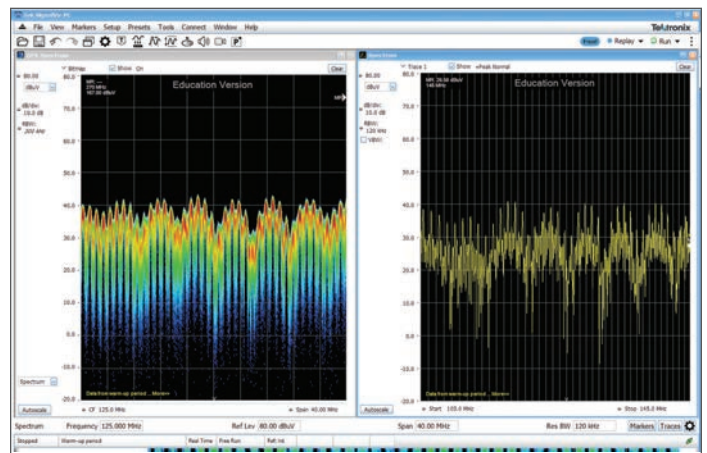

Figure 5 - Without moving the probe, we see "mode 2" from the DC-DC converter, which briefly appeared.

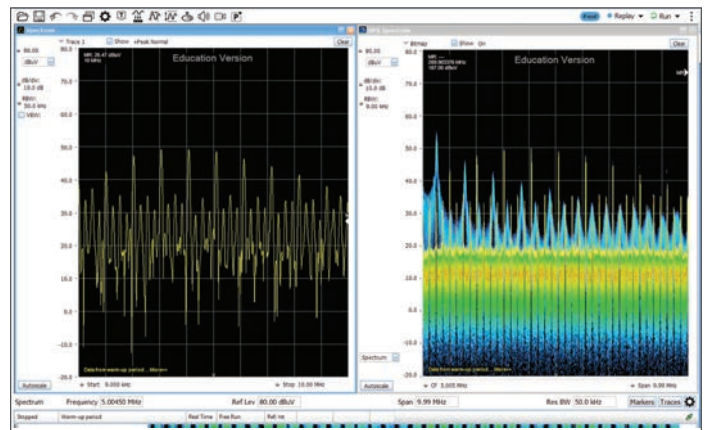

Figure 6 - Again, without moving the probe, we see "mode 3" with much increased narrow band emissions measuring about 10 dB higher than modes 1 and 2. This brief occurrence could have been the mode that would have resulted in a compliance failure, should the emission get coupled out and radiate.

Figures 4, 5, and 6 show the three different spectral modes. Notice that the swept measurement managed to capture only two of the three spectrums. The near field probe was not moved during this

EMC TEST

sequence. Each mode was instantly viewable as the state changed from one mode to another.

EXAMPLE 3 – DETECTION OF SPURIOUS OSCILLATION

In this example, we don't necessarily need the RT capture, but it does yield some interesting visual clues once we activate the spectrogram (waterfall) display feature.

The board being measured is a demo board from Picotest Technologies (Figure 7) and I discovered one of the op-amps produced an interesting bimodal series of spurious oscillations at about 150 MHz intervals. I was able to induce this oscillation by “switching out” the output capacitance.

It turns out that when the op-amp was unloaded capacitively, it produced a very interesting oscillation at near its open loop bandwidth (Figure 8). Examining the RT measurement on the right, we can see there's a distinct bimodal (two-frequency) display, along with some cool sideband emissions. The swept display on the left can only capture one of these two frequencies at a time, at best, as the oscillation is switching from one frequency to the other.

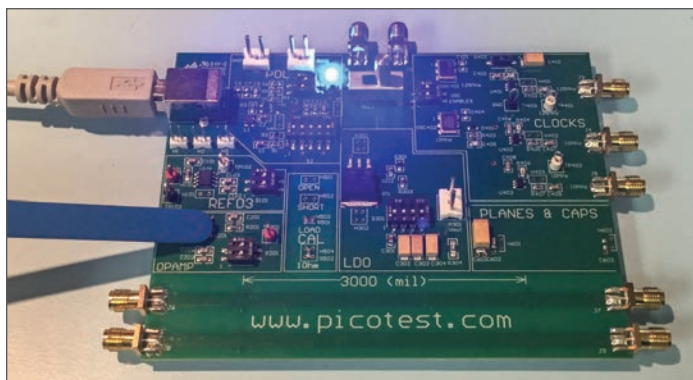

Figure 7 – Measuring an op-amp on the Picotest Technologies demo board.

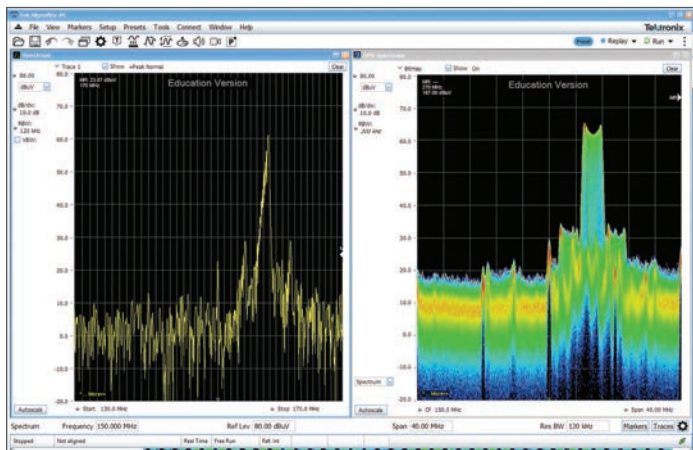

Figure 8 – Measurement of an interesting spurious oscillation of an op-amp. Note that the swept measurement on the left can only capture one of the bimodal states at a time, while the RT capture on the right is very detailed.

But let's analyze the “bi-modal-ness” a little closer by replacing the swept display with a spectrogram of frequency versus time.

One thing I noticed (and this is very common for spurious oscillations) is that placing my finger on the area of the op-amp changed

the parasitic characteristics enough to shift the oscillation frequency quite a bit downward. You can see that shift in the spectrogram display in Figure 9 as I touched my finger to the area twice.

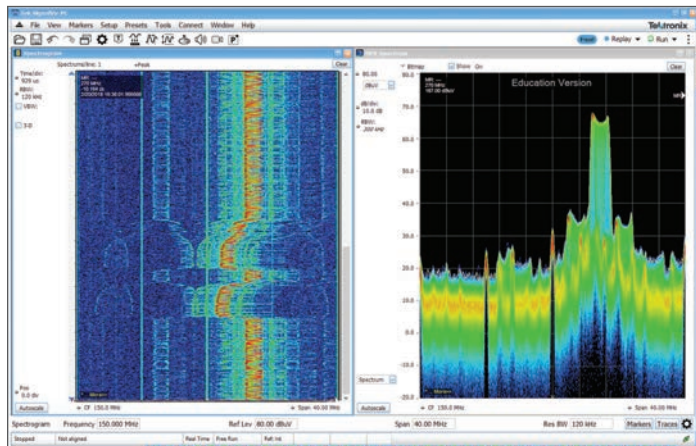

Figure 9 – Replacing the swept display with a spectrogram (frequency versus time), we can observe some interesting details (see text).

The other thing to note is that you can now easily observe the switching between one oscillation frequency and the other in the “zig zag” pattern in the spectrogram. Note that the oscillation spends more time at the lower frequency, rather than the upper frequency. This is also indicated by the slightly higher amplitude of the left side of the double peak.

CONCLUSION

As technology continues to advance, we EMC engineers and product designers need to upgrade our usual analysis and pre-compliance test tools to stay one step ahead and be able to better capture and display the more unusual emissions expected. Real-time spectrum analyzers have already proven to be invaluable for EMI debug and troubleshooting. Advanced spectral analysis will be especially important as mobile devices continue to shrink and more products incorporate wireless and other advanced digital modes.

REFERENCES

1. Tektronix RSA306B spectrum analyzer, <https://www.tek.com>
2. Tekbox Digital Solutions near field probes, <https://tekbox.net>
3. 2017 EMI Pre-Compliance Test Guide, <http://learn.interferencetechnology.com/2017-emc-pre-compliance-test-guide/>
4. Harmonic Analyzer Tool (Patrick André)

AUTHOR BIO

Kenneth Wyatt is president and principal consultant of Wyatt Technical Services LLC, as well as the senior technical editor for Interference Technology. He has worked in the field of EMC engineering for 30 years. His specialty is EMI troubleshooting and pre-compliance testing and is a co-author of the popular EMC Pocket Guide and RFI Radio Frequency Interference Pocket Guide. He also coauthored the book with Patrick André, EMI Troubleshooting Cookbook for Product Designers, with forward by Henry Ott. He is widely published and authored The EMC Blog hosted by EDN.com for nearly three years. Kenneth is a senior member of the IEEE and a long time member of the EMC Society.

ken@emc-seminars.com | kwyatt@interferencetechnology.com
www.emc-seminars.com

ADVERTISERS INDEX

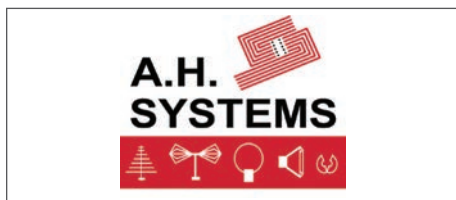

A.H. Systems

9710 Cozycroft Ave.
Chatsworth, CA 91311

t: (818) 998-0223
e: sales@ahsystems.com
w: www.AHSystems.com
page: 2



AR RF/Microwave Instrumentation

First Floor Ashling Building
National Technology Park
Limerick, Ireland

t: +353 61 504300
e: areuropesales@arworld.us
w: www.ar-europe.ie/
page: 4



EMC Live

Online

t: (484) 688-0300
e: graham@item.media
w: www.emc.live
page: 27



Exodus Advanced Communications

3674 East Sunset Road, Suite 100
Las Vegas, NV 89120

t: (702) 534-6564
e: EUSales@exoduscomm.com
w: www.exoduscomm.com
page: 10



ITEM Media

1000 Germantown Pike
Plymouth Meeting, PA 19462

t: (484) 688-0300
e: info@item.media
w: www.item.media
page: 21



Rohde & Schwarz GmbH & Co. KG

Muehldorfstrasse 15
81671 Munich, Germany

t: +49 89 4129 12345
e: customersupport@rohde-schwarz.com
w: www.rohde-schwarz.com
page: 6

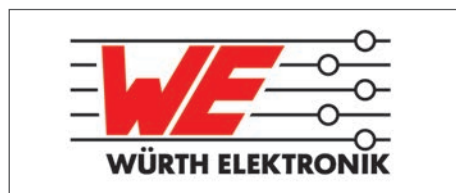

Würth Elektronik

eiSos GmbH & Co. KG Max-Eyth-Str. 1
74638 Waldenburg, Germany

t: +49 7942 9450
e: eiSos@we-online.de
w: www.we-online.com
page: 15

Rohde & Schwarz USA, Inc.

t: (410) 910-7800
w: www.rohde-schwarz-usa.com

2019 EUROPE EMC GUIDE

FRANCE EDITION



ITEM Media 1000 Germantown Pike, F2
Plymouth Meeting, PA 19462 USA

p: +1 484-688-0300

f: +1 484-688-0303

w: www.item.media

e: info@interferencetechnology.com

Subscribe: www.interferencetechnology.com



INTERFERENCE TECHNOLOGY 2019 EUROPE GUIDE SERIES
www.interferencetechnology.com

Copyright © 2019 • ITEM Media