

interference^{ITEM™} technology

THE INTERNATIONAL JOURNAL OF ELECTROMAGNETIC COMPATIBILITY



EUROPE EMC GUIDE

Bonus English Section

FEATURES AND COUNTRIES

06	Standards Updates
07	Standards Organizations
08	Government Sites
09	Institutes/trade associations
12	Worldwide EMC Events
20	United Kingdom
46	Deutschland
70	France
84	Italia
92	España
100	Polska
110	Nederland
120	Schweiz
124	Belgique
134	Österreich
138	Other Countries

BACK COVER

WORLD FIRST



More online at interferencetechnology.eu



NSG 437 & NSG 438 ESD SIMULATORS – BEST-IN-CLASS FEATURES FOR 30 kV ESD TESTING

The NSG 437 and NSG 438 are the most user friendly ESD simulators, offering a unique touch screen and activity log. Even with its bright new color display, the NSG 438 features the longest battery life of any ESD simulator on the market, with over 30,000 discharges at 30 kV on a single battery charge. The simulators also feature a unique activity log, allowing the user to easily scroll through the touch screen to check what has been tested and in what timeframe.

As these simulators are fully compliant to the IEC, ANSI, SAE and ISO standards, they are ideal for use in ESD testing of automobiles and their subassemblies as well as ESD testing of all consumer electronics and white goods, information technology, medical and industrial equipment.

Key Features

- Discharge voltage from 200 V to 30 kV in 100 V steps
- Up to 30 s hold time
- Battery life over 30,000 discharges at 30 kV (NSG 438)
- Over 60 quickly interchangeable discharge networks available (150 pF/330 Ω standard)
- Custom discharge networks from 0 Ω and up to 2 nF
- Built-in ISO self-calibration

CONTENTS

- 4** GUEST EDITORIAL
- 6** EUROPEAN STANDARDS AND RESOURCES
STANDARDS ORGANIZATIONS, GOVERNMENT SITES, INSTITUTES AND TRADE ASSOCIATIONS
- 12** EVENTS AND TRADESHOWS
- 144** INDEX OF ADVERTISERS

All articles are available
online in English at
www.interferencetechnology.eu

United Kingdom 20

- 22** PRODUCTS & SERVICES
- 31** RESOURCES
- 32** APPLYING STEALTH TECHNOLOGY TO EMC TEST CHAMBER DESIGNS
TOM MULLINEAUX, Lionheart Southwest. Inc
- 36** ASSESSING LOW FREQUENCY MAGNETIC FIELD EXPOSURE IN HYBRID AND ELECTRIC VEHICLES
ALASTAIR RUDDLE, LESTER LOW, MIRA Limited

Deutschland 46

- 48** PRODUKTE UND SERVICES
- 58** RESSOURCEN
- 60** MESSEN UNTER STÖRBEEINFLUSSUNG
JÖRG HACKER, Langer EMV-Technik GmbH
- 66** WIE VIEL ESD VERTRÄGT EIN IC?
SVEN KÖNIG, Langer EMV-Technik GmbH

France 70

- 72** PRODUITS ET SERVICES
- 76** RESSOURCES
- 78** NOUVELLES EXIGENCES ET MÉTHODES DE TESTS DE L'UE POUR L'ÉQUIPEMENT DE TRANSMISSION DE DONNÉES ISM 2,4 GHZ
DAVID ZHANG, NIMA MOLAEI, LESLIE BAI, SIEMIC Laboratories

Italia 84

- 86** PRODOTTI E SERVIZI
- 88** RISORSE
- 90** IL PRIMO APPROCCIO PRATICO ALL'EMC PER LA SICUREZZA FUNZIONALE
KEITH ARMSTRONG, Cherry Clough Consultants

España 92

- 94 PRODUCTOS Y SERVICIOS
- 98 LOS RECURSOS

Polska 100

- 102 PRODUKTY I USŁUGI
- 104 ZASOBY
- 106 NOWINY CISPR-OWSKIE
JAN SROKA, Politechnika Warszawska

Nederland 110

- 112 PRODUCTEN EN SERVICES
- 114 MIDDELEN
- 116 ZAAIEN EN OOGSTEN
MART COENEN, EMC MCC

Schweiz 120

- 122 PRODUKTE UND SERVICES
- 123 RESSOURCEN

Belgique 124

- 126 PRODUITS ET SERVICES
- 127 RESSOURCES
- 128 CARACTÉRISATION DES JOINTS DE BLINDAGE ÉLECTROMAGNÉTIQUE JUSQUE 40 GHZ
CHRISTIAN BRULL, Schlegel EMI

Österreich 134

- 136 PRODUKTE UND SERVICES

Europe 139

- 138 PRODUCTS & SERVICES
ALBANIA • ARMENIA • BELARUS • BOSNIA-HERZEGOVINA • BULGARIA • CYPRUS • CZECH REPUBLIC • DENMARK
ESTONIA • FINLAND • GREECE • HUNGARY • IRELAND • LATVIA • LITHUANIA • LUXEMBOURG • MOLDOVA
NORWAY • PORTUGAL • ROMANIA • RUSSIA • SERBIA • SLOVAKIA • SLOVENIA • SWEDEN • UKRAINE



EMC LIVE 2015

THE EASIEST WAY TO GAIN KNOWLEDGE...
FROM THE COMFORT OF YOUR OWN CHAIR

APRIL 28-30, 2015

emclive2015.com

The IEEE EMC 2015 Symposium - Why Dresden?



DEAR READERS*,

IT'S NOT EVERY DAY you get the country famed for engineering excellence hosting a predominantly US event (the country universally accepted as the economic powerhouse of the world, and famous for her entrepreneurial spirit). So this exceptional event has all the makings for a great meeting of great minds.

Germany is the powerhouse that took the EMC industry to new heights during the introduction of the CE mark, so if you are intent on choosing an overseas location to reinforce the international nature of the IEEE EMC society, Germany is the clear choice.

Less clear are the drivers behind the choice of the city of Dresden as the most suitable venue. Most would have expected Munich or another hotbed of high tech industry to be a more obvious choice. As full of history and as beautiful as Dresden is, it would be interesting to know the decision making background that led to the selection of this particular city, and to know the reasons supporting the decision.

Still, they say 'the proof of the pudding is in the eating', so if the attendance count is good, and the reviews favourable, the show will be judged a great success. And in terms of attendance cost, there is every reason for the show to be a success given that, due to competition between airlines, the price of international flights are on a par with US domestic flights. That is you can fly to Europe for a price not so very different to flying East Coast to West Coast in the US. So if the cost of flying from New York to say the Santa Clara 2015 show is not seen as a barrier to attendance, then flying New York to Dresden is not a barrier either.

The IEEE EMC Board of Directors' decision to choose Dresden is discussed in more depth at the Interference Technology blog site EMC-Zone (www.emc-zone.com), and in all probability will be a hot topic discussed by the guest panelists in February 2015's 'Elephants in the Test Room' EMC Live webinar. Be sure to tune in and see.

Training for EMC Test House Staff

And speaking of EMC Live webinars, with training budgets tight, yet with the test house ISO17025 quality system still insisting staff training gaps to be identified and filled, the webinars are a step in the right direction for alert training managers. Check out the archived and upcoming webinar topics to see if they are applicable. The price is definitely right (free). Don't see what you need? Contact the *Interference Technology* editorial staff. They have access to a raft of EMC experts more than capable of creating a suitable webinar where the demand exists. Online education greatly benefits all who choose to use it, and we hope you do.

Tom Mullineaux
Guest Editor

**Editor's Note: These opinions are those of Tom Mullineaux, and do not necessarily reflect the views of Interference Technology.*

SUBSCRIPTIONS

ITEM, *InterferenceTechnology*—The EMC Directory & Design Guide, EMC Symposium Guide, Europe EMC Guide and EMC Test & Design Guide are distributed annually at no charge to engineers and managers engaged in the application, selection, design, test, specification or procurement of electronic components, systems, materials, equipment, facilities or related fabrication services. Subscriptions are available through interferencetechnology.com.

Editor
Belinda Stasiukiewicz

Editorial Assistant
Allison Titus

Graphic Designers
Erica Osting
Evan Schmidt

Marketing Manager
Dawn Hoffman

Marketing Specialist
Jacqueline Gentile

Business Development Executives
Blake Maclean
Katie Tolton
Janet Ward

Administrative Manager
Eileen Ambler

Circulation Manager
Irene Nugent

Product Development Manager
Helen Flood

Data Analyst
Karen Holder

President
Graham S. Kilshaw

Publisher Emeritus
Robert D. Goldblum



USA

1000 Germantown Pike, F-2
Plymouth Meeting, PA 19462
Phone: (484) 688-0300
Fax: (484) 688-0303
Email:
info@item-media.net
www.item-media.net

CHINA, TAIWAN, HONG KONG

Beijing Hescicom Consulting Company
Cecily Bian, +86-010-65250537
E-mail: cecilybian_itc@163.com

JAPAN

e-OHTAMA, LTD.
Midori Hamano, +81-44-980-2092
E-mail: m-hamano@e-ohtama.jp

ITEM Media endeavors to offer accurate information, but assumes no liability for errors or omissions. Information published herein is based on the latest information available at the time of publication. Furthermore, the opinions contained herein do not necessarily reflect those of the publisher.

Copyright © 2014 • ITEM Media • ISSN 0190-0943

CONSIDER THE POSSIBILITIES

Simplify Your Test Setup

1 kW



5U chassis

500W

3U chassis

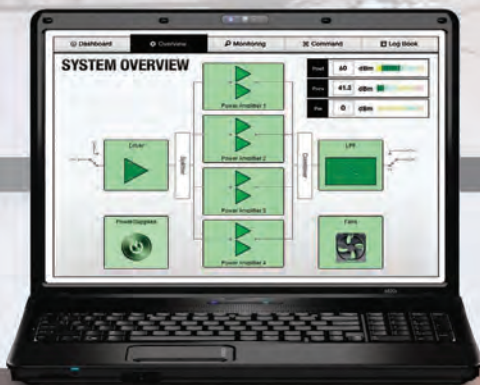

Remote Monitoring & Control
Via Embedded WEB Server

NEXT GENERATION POWER AMPLIFIERS

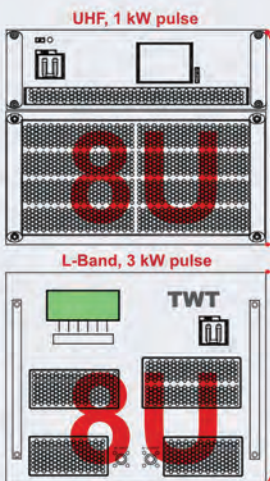

Size Matters

Customer configuration
from a fielded system
Delivering a 56% size reduction



7U

Next Generation Power Amplifier Systems

SKU 2126	1 kW	20 - 500 MHz	5U chassis
SKU 2066	1 kW	500 - 1000 MHz	5U chassis
SKU 2162	1 kW	20 - 1000 MHz	5U chassis
SKU 2170	1 kW	1000 - 3000 MHz	5U chassis
SKU 2175	500 W	80 - 1000 MHz	3U chassis
SKU 2179	250W	2000-6000 MHz	4U chassis

Next Generation Building Block Modules

SKU 1163	125 W	20 - 520 MHz	7 x 4 x 1.2"
SKU 1193	100 W	20 - 1000 MHz	7 x 4 x 1.2"
SKU 1199	100 W	1000 - 3000 MHz	7 x 4 x 1.2"
SKU 1191	100 W	2500 - 6000 MHz	8 x 6.5 x 1"



www.EmpowerRF.com

EMPOWER
RF SYSTEMS, INC.

STANDARDS UPDATE

EUROPE

Compliance with standards can make or break any new product. This section recaps some of the major new and revised EMC standards in the last year from the European standards organizations: the European Committee for Standardization (CEN), the European Committee for Electrotechnical Standardization (CENELEC) and the European Telecommunications Standards Institute (ETSI). Standards are sorted by reference number. Standards information and updates are featured in our weekly Interference Technology eNews; and we also have a vast list of standards at interferencetechnology.com - just click on the Standards section.

European Committee for Electrotechnical Standardization (CENELEC)

EN 16602-20-10:2014

Committee: CENELEC

Status: Published

Date of Publication: 2014-09-17

Title: Space product assurance - Off-the-shelf items utilization in space systems

Scope: This Standard applies to all parties involved at all levels in the utilization of OTS items into space segment hardware and launchers. For the purpose of this Standard, Off-the-Shelf (OTS) Items are those that, even if not necessarily developed for space applications, can be procured from the market and utilized in a space system. This Standard contains the requirements for the utilization of OTS Items, in terms of their selection, characterization and procurement for space system use. This Standard considers complex OTS items, as for example: motherboards, cards, data storage units/items, optical equipments, photo cameras and video units, LANs, mechanical/electrical and electromechanical devices, batteries, sensors, monitoring support units, medical equipments and items, laptops. This Standard does not cover: • software OTS, • re-use of OTS items already qualified for space applications, NOTE However, items not belonging to the same lot of the OTS item already evaluated using this standard, can be subjected to partial re-evaluation and re-qualification since, on the commercial market, fast evolution of the design

occurs. • Pieces, parts and materials, such as electrical, electronic and electromechanical (EEE) parts, thermocouples, rivets, fasteners, connectors, fittings, adhesives, insulation, wiring and plumbing. This standard is not specifically addressing the re-use of OTS items for the same space application for which they were initially qualified. This standard may be tailored for the specific characteristic and constrains of a space project in conformance with ECSS-S-ST-00.

EN 50514:2014

Committee: CENELEC

Status: Published

Date of Publication: 2014-09-19

Title: Audio, video, information technology equipment - electrical safety testing in production

Scope: This European Standard defines routine test procedures for use during or after manufacturing of complete equipment, sub-assemblies or components, certified or declared as complying with EN 60065 or EN 60950-1 and powered by an a.c. or d.c. mains supply. It defines the ROUTINE ELECTRICAL SAFETY TEST and their procedures to be applied during or at the end of the manufacturing process of apparatus certified or declared as complying with EN 60065 or EN 60950-1. The application of the tests detailed in this European Standard is design dependent and needs to be defined by the manufacturer.

EN 50575:2014

Committee: CENELEC

Status: Published

Date of Publication: 2014-09-19

Title: Power, control and communication cables - Cables for general applications in construction works subject to reaction to fire requirements

Scope: This European Standard specifies reaction to fire performance requirements, test and assessment methods for electric cables used for the supply of electricity and for control and communication purposes, which are intended for use in construction works and subject to performance requirements on reaction to fire. The cables covered by this standard are intended to be used for the supply of electricity and communications in buildings and other civil engineering works with the objective of limiting the generation and spread of fire and smoke. Cables intended to be used for the supply of electricity, communication, and fire detection and alarm in buildings and other civil engineering works are not covered by this standard. NOTE: This European Standard does not replace the electrical, mechanical and environmental requirements that are essential to demonstrate compliance with other applicable cable standards/specifications.

EN 60846-1:2014

Committee: CENELEC

Status: Published

Date of Publication: 2014-09-05

Title: Radiation protection instrumentation - Ambient and/or directional dose equivalent (rate) meters and/or monitors for beta, X and gamma radiation - Part 1: Portable workplace and environmental meters and monitors

Scope: IEC 60846-1:2009 specifies the design requirements and the performance characteristics of dose equivalent (rate) meters intended

for the determination of ambient dose equivalent (rate) and directional dose equivalent (rate) as defined in ICRU Report 47. Applies to dose equivalent (rate) meters and/or monitors for the measurement of ambient dose equivalent (rate) and/or directional dose equivalent (rate) from external beta, X and gamma radiation.

International Special Committee on Radio Interference (CISPR)

Project CISPR 14-2 ed2.0

Committee: CIS/F - Interference relating to household appliances tools, lighting equipment and similar apparatus

Status: Work in Progress

Date of Publication: 2015-02-08

Title: Electromagnetic compatibility – Requirements for household appliances, electric tools and similar apparatus – Part 2: Immunity – Product family standard

Scope: This Final Draft International Standard is an up to 3 months' pre-release of the official publication. It is available for sale during its voting period: 2014-10-24 to 2015-01-09. By purchasing this FDIS now, you will automatically receive, in addition, the final publication.

Project CISPR 16-1-6 ed1.0

Committee: CIS/A

Status: Work in Progress

Date of Publication: 2014-12-20

Title: Specification for radio disturbance and immunity measuring apparatus and methods – Part 1-6: Radio disturbance and immunity measuring apparatus – EMC antenna calibration

Scope: This Final Draft International Standard is an up to 3 months' pre-release of the official publication. It was available for sale during its voting period: 2014-09-05 to 2014-11-07. By purchasing this FDIS, you automatically receive, in addition, the final publication.

European Telecommunications Standards Institute (ETSI)

ETSI TS 151 013 V9.0.0

Committee: ESTI

Status: Published

Date of Publication: 2014-07-21

Title: Digital cellular telecommunications system (Phase 2+); Test specification for Subscriber Identity Module (SIM) Application Programming Interface (API) for Java Card (3GPP TS 51.013 version 9.0.0 Release 9)

Scope: The present document covers the minimum characteristics considered necessary in order to provide compliance to 3GPP TS 43.019 [7].

The present document describes the technical characteristics and methods of test for testing the SIM API for Java Card TM (3GPP TS 43.019 [7]) implemented in the Subscriber Identity Modules (SIMs) for GSM. It specifies the following parts: test applicability; test environment description; tests format; test area reference; conformance requirements; test suite files; test procedure; test coverage; and a description of the associated testing tools that shall be used.

ETSI TS 183 063 V3.6.1

Committee: ESTI

Status: Published

Date of Publication: 2014-08-07

Title: Telecommunications and Internet converged Services and Protocols for Advanced Networking (TISPAN); IMS-based IPTV stage 3 specification

Scope: Maintenance of IMS-based IPTV stage 3.

International Electrotechnical Commission (IEC)

IEC 62489-1-am1 ed1.0

Committee: IEC/86A

Status: Published

Date of Publication: 2014-09-09

Title: Optical fibres - Part 1-50: Measurement methods and test procedures - Damp heat (steady state) tests

Scope: IEC 60793-1-50:2014 provides a practical method for evaluating fibre performance in a defined environment. The purpose of this standard is to determine the suitability of optical fibre sub-category A1a to A1d multimode fibres and class B and C single-mode fibres to withstand the environmental condition of high

STANDARDS ORGANIZATIONS

• CEN

The European Committee for Standardization

CEN-CENELEC Management Centre
Avenue Marnix 17
B-1000 Brussels, Belgium
+ 32 2 550 08 11; Fax: + 32 2 550 08 19
www.cen.eu/cenorm/homepage.htm

• CENELEC

European Committee for Electrotechnical Standardization

17, Avenue Marnix
B-1000 Brussels, Belgium
+32 2 519 68 71; Fax: +32 2 519 69 19
www.cenelec.org

• ETSI

European Telecommunications Standards Institute

ETSI Secretariat
650, Route des Lucioles
06921 Sophia-Antipolis Cedex, France
+33 (0)4 92 94 42 00
Fax: +33 (0)4 93 65 47 16
info@etsi.org; www.etsi.org

• IEC

International Electrotechnical Commission

IEC Central Office
3, rue de Varembe, P.O. Box 131
CH - 1211 Geneva 20, Switzerland
+41 22 919 02 11, Fax: +41 22 919 03 00
info@iec.ch, www.iec.ch;
IEC's EMC Zone: www.iec.ch/zone/emc/emc_entry.htm

• CISPR

International Special Committee on Radio Interference

IEC Central Office, 3
rue de Varembe, P.O. Box 131, CH - 1211
Geneva 20, Switzerland
+41 22 919 02 11, Fax: +41 22 919 03 00
info@iec.ch, www.iec.ch
IEC's EMC Zone: ; www.iec.ch/zone/emc/emc_cis.htm

• International Organization for Standardization

ISO Central Secretariat: 1,
ch. de la Voie-Creuse, Case postale 56
CH- 1211 Geneva 20, Switzerland;
+41 22 749 01 11; Fax +41 22 733 34 30;
www.iso.org

humidity and high temperature which may occur in actual use, storage and/or transport. The test is primarily intended to permit the observation of effects of high humidity at constant temperature over a given period. This procedure is conducted in accordance with IEC 60068-2-78, Test Cab. This second edition cancels and replaces the first edition, published in 2001, and constitutes a technical revision. This edition includes the following significant technical changes with respect to the previous edition:

- harmonization of the content with sectional specifications of relevant fibre types;
- extension of the applicability of the standard to class C single-mode fibres. Keywords: evaluating fibre performance, sub-category A1a to A1d multimode fibres, class B and C single-mode fibres, high humidity and high temperature.

Project IEC 60695-1-12 ed1.0

Committee: IEC/89

Status: Work in Progress

Date of Publication: Forecast of publication 2014-12-27

Title: Fire hazard testing – Part 1-12: Guidance for assessing the fire hazard of electrotechnical products – Fire safety engineering

Scope: This Final Draft International Standard is an up to 3 months' pre-release of the official publication. It was available for sale during its voting period: 2014-09-12 to 2014-11-14. By purchasing this FDIS, you automatically receive, in addition, the final publication.

IEC 60825-1 ed3.0

Committee: IEC/76

Status: Published

Date of Publication: 2014-05-15

Title: Safety of laser products - Part 1: Equipment classification and requirements

Scope: IEC 60825-1:2014 is applicable to safety of laser products emitting laser radiation in the wavelength range 180 nm to 1 mm. A laser product may consist of a single laser with or without a separate power supply or may incorporate one or more lasers in a complex optical, electrical, or mechanical system. Typically, laser products are used for demonstration of physical and optical phenomena, materials processing, data reading and storage, transmission and display of information, etc. Such systems have found use in industry, business, entertainment, research, education, medicine and consumer products. Laser products that are sold to other manufacturers for use as components of any

system for subsequent sale are not subject to IEC 60825-1, since the final product will itself be subject to this standard. Laser products that are sold by or for manufacturers of end products for use as repair parts for the end products are also not subject to IEC 60825-1. However, if the laser system within the laser product is operable when removed from the end product, the requirements of this Part 1 apply to the removable laser system. The objectives of this part of IEC 60825 are:

- to introduce a system of classification of lasers and laser products emitting radiation in the wavelength range 180 nm to 1 mm according to their degree of optical radiation hazard in order to aid hazard evaluation and to aid the determination of user control measures;

- to establish requirements for the manufacturer to supply information so that proper precautions can be adopted;

- to ensure, through labels and instructions, adequate warning to individuals of hazards associated with accessible radiation from laser products; and

- to reduce the possibility of injury by minimizing unnecessary accessible radiation and to give improved control of the laser radiation hazards through protective features. This edition includes the following significant technical changes with respect to the previous edition:

- a new class, Class 1C, was introduced;

- the measurement condition 2 ("eye loupe" condition) was removed;

- a classification of the emission of laser products below a certain radiance level that are intended to be used as replacement for conventional light sources can, as an option, be based on the IEC 62471 series;

- and the accessible emission limits (AELs) for Class 1, 1M, 2, 2M and 3R of pulsed sources, particularly of pulsed extended sources, were updated to reflect the latest revision of the ICNIRP guidelines on exposure limits (accepted for publication in Health Physics Journal 2013, see also www.icnirp.org).

IEC 60086-4 ed4.0

Committee: IEC/35

Status: Published

Date of Publication: 2014-09-03

Title: Primary batteries - Part 4: Safety of lithium batteries

Scope: IEC 60086-4:2014 specifies tests and requirements for primary lithium batteries to ensure their safe operation under intended use and reasonably foreseeable misuse. This fourth

edition cancels and replaces the third edition published in 2007. This edition constitutes a technical revision. This edition includes the following significant technical changes with respect to the previous edition:

- Harmonisation with the second edition of IEC 62281;

- Alternative protective circuits in 7.1.1;

- More information regarding risks of swallowing lithium batteries in (former) 7.2.m) and promotion of this item to 7.2.a);

- A new Annex D with pictograms for some of the safety precautions in 7.2. Keywords: lithium batteries

IEC 60092-350 ed4.0

Committee: IEC/18A

Status: Published

Date of Publication: 2014-08-12

Title: Electrical installations in ships - Part 350: General construction and test methods of power, control and instrumentation cables for shipboard and offshore applications

Scope: IEC 60092-350:2014 provides the general constructional requirements and test methods for use in the manufacture of electric power, control and instrumentation cables with copper conductors intended for fixed electrical systems at voltages up to and including 18/30(36) kV on board ships and offshore (mobile and fixed) units. The following types of cables are not included: - optical fibre; - sub-sea and umbilical cables; - data and communication cables; - coaxial cables. This edition includes the following significant technical changes with respect to the previous edition:

- a) reference to IEC 60092-360 for both the insulating and sheathing compounds;

- b) partial discharge tests have been transferred from IEC 60092-354 to align it with IEC 60092-353;

- c) requirements for oil and drilling-fluid resistance (former Annexes F and G) have been transferred to IEC 60092-360;

- d) requirements for cold bending and shocks have been improved;

- e) the document reflects the changes of material types that have been introduced during the development of IEC 60092-353 and IEC 60092-360.

IEC 60092-354 ed3.0

Committee: IEC/18A

Status: Published

Date of Publication: 2014-08-25

Title: Electrical installations in ships - Part 354: Single- and three-core power cables with extruded solid insulation for rated voltages 6 kV ($U_m = 7,2$ kV) up to 30 kV ($U_m = 36$ kV)

Scope: IEC 60092-354:2014 is applicable to shipboard and offshore power cables with extruded solid insulation, conductor and core screening, having a voltage rating of one of the following:

3,6/6 (7,2) kV, 6/10 (12) kV, 8,7/15 (17,5) kV, 12/20 (24) kV, 18/30 (36) kV. The cables are intended for fixed installations. The object of this standard is:

- to standardize cables whose safety and reliability are ensured when they are installed in accordance with the requirements of IEC 60092-352 or IEC 61892-4;

- to lay down standard manufacturing requirements and characteristics of such cables directly or indirectly bearing on safety;

- to specify test methods for checking conformity with those requirements.

This edition includes the following significant technical changes with respect to the previous edition:

a) Modification of construction requirements in line with IEC 60092-350. There has been some redistribution of test methods between IEC 60092-350 and this new standard to remove all tests carried out on complete cables.

b) Requirements for enhanced cold properties, oil resistance and resistance to drilling fluids have been aligned to IEC 60092-350.

IEC 60115-8-1 ed2.0

Committee: 40 - Capacitors and resistors for electronic equipment

Status: Published

Date of Publication: 2014-10-17

Title: Fixed resistors for use in electronic equipment - Part 8-1: Blank detail specification: Fixed surface mount (SMD) low power film resistors for general electronic equipment, classification level G

Scope: IEC 60115-8-1:2014 is applicable to the drafting of detail specifications for fixed surface mount (SMD) low-power film resistors in rectangular chip shape (styles RR) or in cylindrical MELF shape (styles RC) classified to level G, which is defined in IEC 60115-8:2009, 1.5 for general electronic equipment, typically operated under benign or moderate environ-

mental conditions, where the major requirement is function. Examples for level G include consumer products and telecommunication user terminals. This edition includes the following significant technical changes with respect to the previous edition:

- It includes minor revisions related to tables, figures and references.

- Dedication to resistors of product classification level G, which is for general electronic equipment, typically operated under benign or moderate environmental conditions, like e.g. consumer products, or telecommunication user terminals.

- Implementation of the zero defect policy with the application of the single assessment level EZ in all test schedules.

- Substitution of the temperature coefficient of resistance (TCR), specified over the full defined temperature range, for the inferior and less significant temperature characteristic.

- Addition of a test for the immunity against electrostatic discharge.

- Implementation of the concept of stability classes with coordinated requirements to the performance at all prescribed tests.

- Addition of information relevant for the component user in his assembly process.

- Addition of an Annex providing special provisions for 0 resistors (jumpers), which may be part of a range of products covered by a detail specification derived from this blank detail specification.

IEC 61000-6-7 ed1.0

Committee: 77 - Electromagnetic compatibility

Status: Published

Date of Publication: 2014-10-09

Title: Electromagnetic compatibility (EMC) - Part 6-7: Generic standards - Immunity requirements for equipment intended to perform functions in a safety-related system (functional safety) in industrial locations

Scope: IEC 61000-6-7:2014 is intended to be used by suppliers when making claims for the immunity of equipment intended for use in safety-related systems against electromagnetic disturbances. This standard should also be used by designers, integrators, installers, and assessors of safety-related systems to assess the claims made by suppliers. It provides guidance to product committees. This part of IEC 61000 applies to electrical and electronic equipment intended for use in safety-related systems and that is:

GOVERNMENT SITES

• CEOC International

Secretariat, Rue du Commerce 20-22, B-1000 Brussels, Belgium
+32 2 511 5065; Fax: +32 2 502 5047
info@ceoc.com; www.ceoc.com

• EFTA

(European Free Trade Association)

Headquarters: 9-11, rue de Varembe, CH-1211 Geneva 20, Switzerland
+41 22 332 26 00; Fax: +41 22 332 26 77
mail.gva@efta.int; www.efta.int

• European Commission

Secretariat-General
B-1049 Brussels, Belgium
<http://ec.europa.eu>

• European New Legislative Framework for marketing of products

<http://ec.europa.eu/enterprise/policies/single-market-goods/regulatory-policies-common-rules-for-products/new-legislative-framework>

• European Environment Agency

Kongens Nytorv 6, DK
1050 Copenhagen K, Denmark
+45 3336 7100; Fax: +45 33 36 71 99
<http://www.efta.int>

• Rapex - Rapid Alert System for non-food dangerous products

EU consumer alerts about unsafe products
European Commission, Health & Consumers
Directorate-General, B - 1049 Brussels, Belgium; http://ec.europa.eu/consumers/dyna/rapex/rapex_archives_en.cfm

INSTITUTES & TRADE ASSOCIATIONS

• Electromagnetic Compatibility Industry Association

Nutwood UK Limited
Eddystone Court, De Lank Lane, St. Breward, Bodmin, Cornwall. PL30 4NQ
+44 (0) 1208 851 530
Fax: +44 (0) 1208 850 871
www.emcia.org

• Electromagnetics Society (ACES)

President Osama Mohammed
ECE Department
Florida International University
10555 W. Flagler Street, EAS-3983,
Miami, FL 33174 USA; +1-305-348-3040
mohammed@fiu.edu
<http://aces.ee.olemiss.edu/>

• Energy Institute (EI)

61 New Cavendish Street
London W1G 7AR, United Kingdom
+44 (0) 20 7467 7100
info@energyinst.org; www.energyinst.org

- intended to comply with the requirements of IEC 61508 and/or other sector-specific functional safety standards;

- and intended to be operated in industrial locations as described in 3.1.15. The object of this standard is to define immunity test requirements for equipment in relation to continuous and transient, conducted and radiated disturbances, including electrostatic discharge. These requirements apply only to functions intended for use in functional safety applications. Test requirements are specified for each port considered.

IEC 62396-5 ed1.0

Committee: IEC/107

Status: Published

Date of Publication: 2014-08-22

Title: Process management for avionics - Atmospheric radiation effects - Part 5: Assessment of thermal neutron fluxes and single event effects in avionics systems

Scope: IEC 62396-5:2014(E) provides a more precise definition of the threat that thermal neutrons pose to avionics as a second mechanism for inducing single event upset (SEU) in microelectronics. IEC 62396-5 addresses two main items:

- a detailed evaluation of the existing literature on measurements of the thermal flux inside of airliners, and

- an enhanced compilation of the thermal neutron SEU cross-section in currently available SRAM devices (more than 20 different devices). The net result of the reviews of these two different sets of data will be two ratios that are considered to be very important for leading to the ultimate objective of determining how large a threat is. This new edition includes the following technical changes with respect to the previous technical specification: document upgraded to an IEC international standard, change to title, updated references and bibliography, consideration of smaller geometries, addition of recent data on neutron cross-sections, etc.

IEC 60127-6 ed2.0

Committee: IEC/32C

Status: Published

Date of Publication: 2014-09-03

Title: Miniature fuses - Part 6: Fuse-holders for miniature fuse-links

Scope: IEC 60127-6:2014 is applicable to fuse-holders for miniature cartridge fuse-links

according to IEC 60127-2 and sub-miniature fuse-links according to IEC 60127-3 for the protection of electric appliances, electronic equipment and component parts thereof, normally intended for use indoors. Examples of fuse-holder types with different features are given. This part of IEC 60127 applies to fuse-holders with:

- a maximum rated current of 16 A; and

- a maximum rated voltage of 1 500 V d.c. or 1 000 V a.c.; and

- for use up to 2 000 m above sea-level, unless otherwise specified. The object of this standard is to establish uniform requirements for safety and the assessment of electrical, mechanical, thermal and climatic properties of fuse-holders and the compatibility between fuse-holders and fuse-links. This second edition cancels and replaces the first edition published in 1994, its Amendment 1 (1996) and Amendment 2 (2002). This edition constitutes a technical revision. This edition includes the following significant technical changes with respect to the previous edition:

- modify the arrangement of the fuse-holder samples in the planes in 13.1.1;

- add a new test 13.2.2: Glow-wire ignition test;

- change maximum gauge size for standard sheets 3 and 4 from 0,70 to 0,63 in table 5;

- change minimum gauge size for standard sheets 3 and 4 from 0,55 to 0,56 in table 5. Keywords: fuse-holders for miniature cartridge fuse-links, sub-miniature fuse-links, protection of electric appliances, electronic equipment and component parts.

IEC 60947-1 ed5.2 Consol. with am1&2

Committee: IEC/121A

Status: Published

Date of Publication: 2014-09-09

Title: Low-voltage switchgear and controlgear - Part 1: General rules

Scope: IEC 60947-1:2007+A1:2010+A2:2014 is to harmonize as far as practicable all rules and requirements of a general nature applicable to low-voltage switchgear and controlgear in order to obtain uniformity of requirements and tests throughout the corresponding range of equipment and to avoid the need for testing to different standards. It bears the edition number 5.1. The technical content is therefore identical to the base edition and its amendment and has been prepared for user convenience. A vertical line in

the margin shows where the base publication has been modified by amendment 1. Additions and deletions are displayed in red, with deletions being struck through. This consolidated version consists of the fifth edition (2007), its amendment 1 (2010) and its amendment 2 (2014). Therefore, no need to order amendments in addition to this publication.

IEC 61347-2-13 ed2.0

Committee: IEC/34C

Status: Published

Date of Publication: 2014-09-03

Title: Lamp controlgear - Part 2-13: Particular requirements for d.c. or a.c. supplied electronic controlgear for LED modules

Scope: IEC 61347-2-13:2014 specifies particular safety requirements for electronic controlgear for use on d.c. or a.c. supplies up to 1 000 V (a.c. at 50 Hz or 60 Hz) and at an output frequency which can deviate from the supply frequency, associated with LED modules. Controlgear for LED modules specified in this standard are designed to provide constant voltage or current at SELV or higher voltages. Deviations from the pure voltage and current types do not exclude the gear from this standard. This second edition cancels and replaces the first edition published in 2006. This edition constitutes a technical revision. This edition includes the following significant technical changes with respect to the previous edition.

a) Replacement of the SELV-equivalent requirements by SELV requirements and reference to the SELV requirements of Annex L in IEC 61347-1:2007/AMD2:2012.

b) Reference to IEC 61347-1 for the protection against accidental contact with live parts, moisture resistance and insulation and electric strength.

c) New Annex J for emergency lighting requirements.

IEC/TR 61641 ed3.0

Committee: IEC/121B

Status: Published

Date of Publication: 2014-09-09

Title: Enclosed low-voltage switchgear and controlgear assemblies - Guide for testing under conditions of arcing due to internal fault

Scope: IEC TR 61641:2014 gives guidance on the method of testing of ASSEMBLIES under conditions of arcing in air due to an internal

fault. The purpose of this test is to assess the ability of the ASSEMBLY to limit the risk of personal injury, damage of ASSEMBLIES and its suitability for further service as a result of an internal arcing fault. This third edition cancels and replaces the second edition published in 2008. It constitutes a technical revision. This third edition includes the following significant technical changes with respect to the previous edition:

- arcing classes to define the different forms of protection provided against arcing faults; (i) personnel protection, (ii) damage restricted to part of the ASSEMBLY, and (iii) ASSEMBLY suitable for limited further service.;

- two levels of personnel protection afforded by ASSEMBLIES under arcing fault conditions; (i) for ASSEMBLIES installed in areas where access to the ASSEMBLY is restricted to skilled persons, and (ii) for ASSEMBLIES installed in areas where the area is accessible to ordinary persons;

- option of individually insulating all live conductors to make the complete ASSEMBLY an arc ignition protected zone (referred to as an 'arc free zone' in previous editions of the Technical report);

- arc fault protection front, back and sides of an ASSEMBLY as the normal requirement;

- minimum performance requirements for arc ignition protected zone.

IEC 62798 ed1.0

Committee: IEC/27

Status: Published

Date of Publication: 2014-08-25

Title: Industrial electroheating equipment - Test methods for infrared emitters

Scope: IEC 62798:2014 specifies test procedures, conditions and methods according to which the main parameters and the main operational characteristics of industrial infrared emitters are established. A limitation of the scope of this standard is that the infrared emitters have a maximum spectral emission at longer wavelengths than 780 nm in air or vacuum, and are emitting wideband continuous spectra such as by thermal radiation or high pressure arcs.

International Standards Organization (ISO)

ISO 8598-1:2014

Committee: ISO/TC 172/SC 7

Status: Published

Date of Publication: 2014-09-16

Title: Optics and optical instruments -- Focimeters -- Part 1: General purpose instruments

Scope: ISO 8598-1:2014 specifies requirements and test methods for general purpose focimeters designed for the measurement of vertex powers, cylinder axis, prismatic power and prism base setting within a restricted area at a specified location of a lens.

This excludes instruments that can only measure the whole lens at once. It is applicable to instruments typically intended for use by the ophthalmic community, with the capability to demonstrate conformity of spectacle lens products with the International Standards existing for these lenses.

ISO/IEC 18000-7:2014

Committee: ISO/IEC

Status: Published

Date of Publication: 2014-09-02

Title: Information technology -- Radio frequency identification for item management -- Part 7: Parameters for active air interface communications at 433 MHz

Scope: ISO/IEC 18000-7:2014 defines the air interface for radio frequency identification (RFID) devices operating as an active RF tag in the 433 MHz band used in item management applications. It provides a common technical specification for RFID devices that can be used by ISO technical committees developing RFID application standards. ISO/IEC 18000-7:2014 is intended to allow for compatibility and to encourage interoperability of products for the growing RFID market in the international marketplace.

It defines the forward and return link parameters for technical attributes including, but not limited to, operating frequency, operating channel accuracy, occupied channel bandwidth, maximum power, spurious emissions, modulation, duty cycle, data coding, bit rate, bit rate accuracy, bit transmission order, and, where appropriate, operating channels, frequency hop rate, hop sequence, spreading sequence, and chip rate. It further defines the communications protocol used in the air interface.

• European Federation for Non-Destructive Testing

European Building Services srl,
80, avenue de l'Opale
B-1030 Brussels; Belgium
+32274 32980; www.efndt.org

• EUROLAB - European Federation of National Assoc. of Measurement, Testing and Analytical Laboratories

Rue du Commerce 20-22
B-1000 Brussels, Belgium
+32 2 511 5065, Fax: +32 2 502 5047
secretariat@eurolab.org; www.eurolab.org

• IEC System for Conformity Testing and Certification of Electrical Equip.

Executive Secretary IECEE
c/o IEC Central Office, 3, Rue de Varembe,
PO Box 131, 1211 Geneva 20, Switzerland;
+41 22 919 02 23; www.iecee.org

• IEEE EMC Society

IEEE Corporate Office
3 Park Avenue, 17th Floor
New York, N.Y. 10016-5997 USA
+1 212 419 7900; Fax: +1 212 752 4929;
www.ewh.ieee.org/soc/emcs

• IEEE Product Safety Eng. Society

IEEE Corporate Office
3 Park Avenue, 17th Floor
New York, N.Y. 10016-5997 USA
+1 212 419 7900; Fax: +1 212 752 4929;
http://ewh.ieee.org/soc/pses

• iNARTE, International Association for Radio, Telecommunications and Electromagnetics

840 Queen Street
New Bern, NC 28560 USA
+1-252-672-0200; +1-800-89-NARTE
Fax: +1-252-672-0111; www.narte.org

• Institution of Engineering and Technology

Michael Faraday House, Six Hills Way,
Stevenage, Herts SG1 2AY United Kingdom
+44 (0)1438 313 311; Fax: +44 (0)1438 765 526
postmaster@theiet.org; www.theiet.org

• International Accreditation Forum, Inc. (IAF)

IAF Secretariat
28 Chemin Old Chelsea, Box 1811
Chelsea, Quebec, Canada, J9B 1A0
+1 (613) 454 8159; www.iaf.nu

• International Laboratory Accreditation Cooperation

The ILAC Secretariat
PO Box 7507
Silverwater, NSW 2128, Australia
+61 2 9736 8374; ilac@nata.com.au; www.ilac.org/home.html

EMC EVENTS

Keep up on important events in the electromagnetic compatibility community in this section. Visit Interference Technology online at www.interferencetechnology.com for more listings. If you would like to add an event, e-mail details to editor Belinda Stasiukiewicz at bstas@item-media.net.

MMWATT — 2014 Third Conference on Millimeter-Wave and Terahertz Technologies

WHEN: 30 Dec 2014 - 01 Jan 2015

WHERE: Tehran, Iran

WHAT: The research, development, and applications of millimeter-wave and terahertz technologies in Circuits and Devices, Communication Systems, Microwave Photonics, Antennas and Propagation, Modeling and Numerical Techniques, Measurements.

INFORMATION: www.mmwatt.ir/ipaper/mmwatt2014

EMC Live Design Bootcamp

WHEN: 18 February 2015

WHERE: Online

WHAT: This is a 1-day, highly focused event for design electronics engineers across all major industries, dedicated to the latest in EMC design tools, components, materials and techniques, hosted by *Interference Technology*.

INFORMATION: www.emclive2015.com

International Workshop on Antenna Technology

WHEN: 4-6 March 2015

WHERE: Seoul, Korea

WHAT: The International Workshop on Antenna Technology (iWAT) is an annual forum for the exchange of information on the research and development of innovative antenna technologies. Topics include small antennas, innovative structures and materials and applications.

INFORMATION: www.iwat2015.org

Smart Systems Integration 2015

WHEN: 11-12 March 2015

WHERE: Copenhagen, Denmark

WHAT: Smart Systems Integration is the international communication platform for research institutes and manufacturers to exchange information on smart systems integration and to create the basis for successful research cooperation with a focus on Europe.

INFORMATION: www.mesago.de/en/SSI/home.htm

Design, Automation & Test in Europe Conference (DATE) 2015

WHEN: 9-13 March 2015

WHERE: Grenoble, France

WHAT: DATE is an international event and networking opportunity for the design and engineering of systems-on-chip, systems-on-board and embedded systems software. Suppliers of development tools and platforms for hardware and software development exhibit a range of information and products relating to front-end to back-end chip design, silicon test and manufacturing, system architecture and embedded software implementation.

INFORMATION: www.date-conference.com

2015 IEEE Symposium on Electromagnetic Compatibility & Signal Integrity

WHEN: 15-21 March 2015

WHERE: Santa Calara, Calif. US

WHAT: EMCSI 2015 Symposium will be striving to "Keep Interference at Bay" by providing the most current information, tools and techniques on EMC testing and signal and power integrity.

The Symposium appeals to a vast audience, from novice to veteran, across all industries and academia. Plan ahead to join your colleagues and experts/innovators in Santa Clara, California for a full week of learning, collaboration and networking with fellow industry peers.

INFORMATION: www.emc2015usa.emcss.org

GeMiC — 2015 German Microwave Conference

WHEN: 16-18 March 2015

WHERE: Nuremberg, Germany

WHAT: Following the success of previous events, the German Institute for Microwave and Antenna Technologies (IMA) in association with the German Association for Electrical, Electronic & Information Technologies (VDE) and the European Microwave Association (EuMA) and the Institute of Electrical and Electronics Engineers, IEEE, through its MTT/AP Joint Chapter, IEEE Germany Section are pleased to announce the 9th German Microwave Conference, GeMiC 2015, to be held in Nürnberg, Germany, on 16–18th March 2015. With its presentations, workshops and its microwave exhibition GeMiC 2015 offers plenty of opportunities to exchange scientific and technical information. Each year, the conference strives to establish and foster collaboration as well as promoting young researchers, both at German and international levels.

INFORMATION: www.gemic2015.de

31st International Review of Progress in Applied Computational Electromagnetics (ACES 2015)

WHEN: 22-26 March 2015

WHERE: Williamsburg, Virginia

WHAT: The International Applied Computational Electromagnetics Society (ACES) Sym-

emv

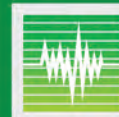

International Exhibition with Workshops
on Electromagnetic Compatibility (EMC)
Stuttgart, Germany, 24–26 March 2015

Take the chance to step into the European market!
Save the date and come to Germany to be part of
Europe's marketplace for electromagnetic compatibility.

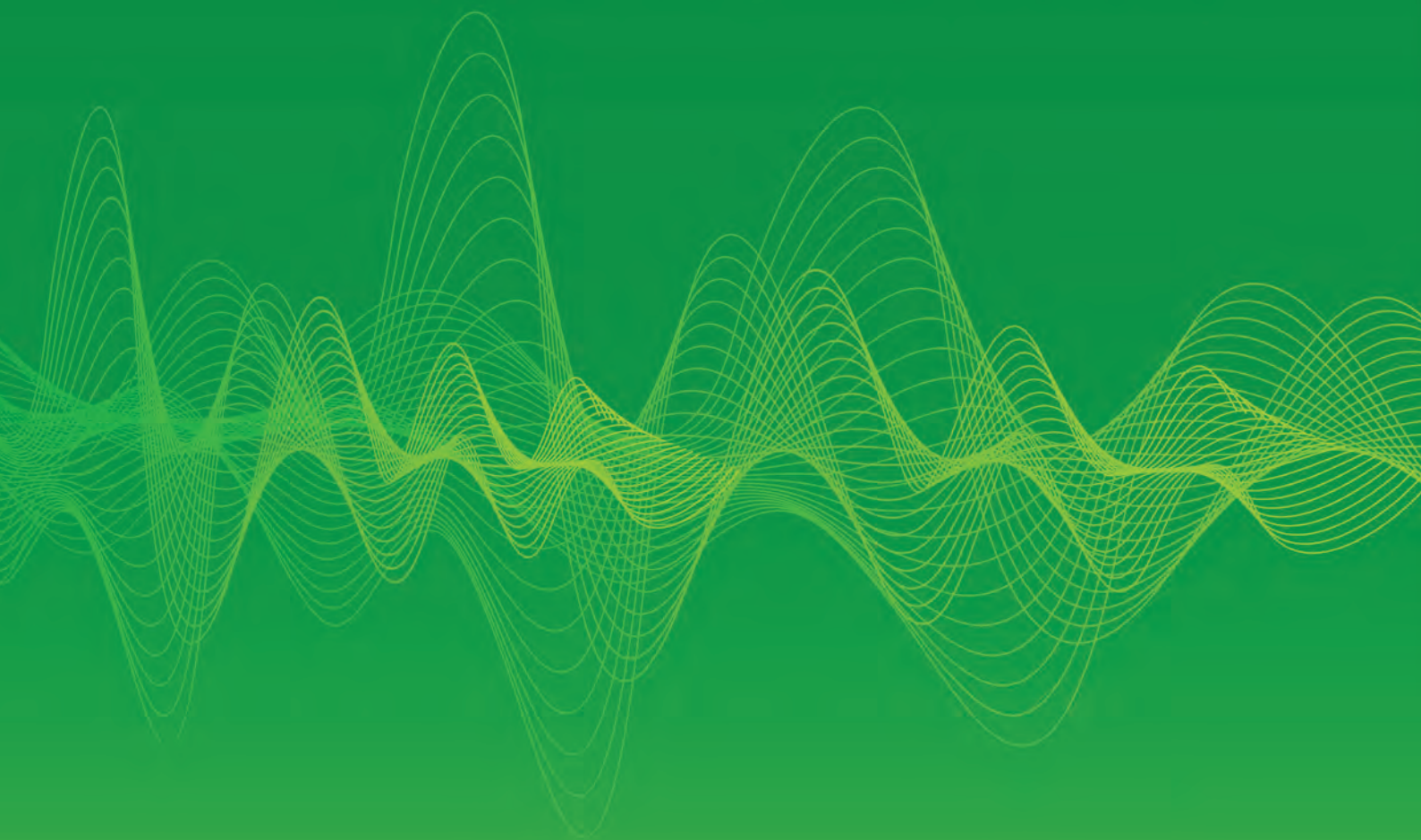

Further information:
web: e-emc.com
phone: +49 711 61946 63
email: emv@mesago.com

mesago
Messe Frankfurt Group

posium serves as a forum for developers, analysts, and users of computational techniques applied to electromagnetic field problems for all frequency ranges. The symposium includes technical invited plenary and regular presentations, software tutorials, vendor booths, and short courses.

INFORMATION: www.aces-society.org

EMV 2015

WHEN: 24-26 March 2015

WHERE: Stuttgart, Germany

WHAT: Europe's leading application-oriented conference on electromagnetic compatibility highlights the requirements of EMC and provides a comprehensive information program that includes reports on the newest products and developments. Specialists from all over the world are available for technical discussion.

INFORMATION: www.mesago.de/en/EMV/home.htm

ExpoElectronica 2015

WHEN: 24-26 March 2015

WHERE: Moscow, Russia

WHAT: ExpoElectronica is one of the largest exhibitions for electronic components and technologies in Russia and Eastern Europe, and consists of three smaller trade fairs. The largest, ExpoElectronica, is an international trade fair for components, PCBs and electronic production while ElectronTechExpo focuses on electronics manufacturing technology. The newest trade fair, LEDTechExpo, covers LED solutions, chips and production facilities.

INFORMATION: <http://expoelectronica.primexpo.ru/en>

Microwave & RF 2015

WHEN: 1-2 April 2015

WHERE: Paris, France

WHAT: Microwave & RF 2015, the show of radio frequencies, microwaves, wireless, EMC and optical fiber, features exhibits, seminars and professional networking opportunities devoted to all aspects of the EMC industry.

INFORMATION: www.microwave-rf.com/

European Conference on Antennas & Propagation (EuCAP) 2015

WHEN: 12-17 April 2015

WHERE: Lisbon, Portugal

WHAT: The 9th annual European Conference of Antennas and Propagation provides a forum for the exchange of scientific and technical information on the latest developments in antenna theory and technology, electromagnetic wave propagation and antenna measurement techniques. Members of both industry and academia are welcome to attend.

INFORMATION: www.eucap2015.org

EMC Live 2015

WHEN: 28-30 April 2015

WHERE: Online

WHAT: This is a practical, free 3-day online event on everything related to EMC hosted by *Interference Technology*. Program highlights include EMC/EMI Testing, HEMP/ IEMI Threats, Troubleshooting EMI, Standards Updates, Compliance Testing, Designing for EMC, MIL-STD 461 and more!

INFORMATION: www.emclive2015.com

2015 IEEE International Radar Conference

WHEN: 11-15 May 2015

WHERE: Arlington, Va., US

WHAT: Applications of radar can now literally be found from "Underground to Outer Space", from ground and foliage penetration (GPEN/ FOPEN), to long range airborne surveillance, remote sensing and deep space. These applications are enabled by a plurality of technologies including advanced RF components and subsystems, to state-of-the-art real-time high performance embedded computing (HPEC) and machine learning and intelligence.

INFORMATION: www.ieeeintradar2015.com

SVIAZ-EXPOCOMM 2015

When: 12-15 May 2015

Where: Moscow, Russia

What: The International Exhibition for Telecommunications, Control Systems, IT and Communication Services is an information technology and telecommunication event used by many overseas IT manufacturers to promote their products and develop their business in Russia. The conference showcases the latest innovative products, technologies and services, and serves as a place for industry professionals to network and exchange information.

INFORMATION: <http://expocomm.ru/en>

Power Conversion Intelligent Motion (PCIM) 2015

WHEN: 19-21 May 2015

WHERE: Nuremberg, Germany

WHAT: PCIM offers numerous oral and poster sessions, seminars and tutorials that provide state-of-the-art application information on power electronics. Specialists from all over the world will report on their latest products and applications and will be available for technical discussions.

INFORMATION: www.mesago.de/en/PCIM

European Wireless 2015

WHEN: 20-22 May 2015

WHERE: Budapest, Hungary

WHAT: The European Wireless Conference focuses on all aspects of telecommunications, including ongoing research, new products and technology. This year's conference will focus on "5G and beyond."

INFORMATION: <http://ew2015.european-wireless.org>

Int'l Symposium on Industrial Electronics (ISIE) 2015

WHEN: 3-5 June 2015

WHERE: Rio de Janeiro, Brazil

WHAT: IEEE-ISIE is one of the most traditional conferences of the IEEE Industrial Electronics Society. In this conference, professionals from industry, academy and research centers from around the world exchange experiences and research results aiming to technology transfer and to provoke new R&D subjects for fostering development in the industrial electronics and its applications. Researchers and engineers from all related sectors are invited to participate by submitting papers, tutorial proposals and special session proposals. Furthermore, you are invited to participate at the conference, where there will be high standard selected presentations, tutorials, besides the social activities.

INFORMATION: www.batlab.ufms.br/isie2015/

15th IEEE Conference on Environmental and Electrical Engineering (EEEIC 2015)

WHEN: 10-13 June 2015

WHERE: Rome, Italy

Setting the Global Standards for Static Control!

Solve business challenges for controlling ESD by networking with other ESD professionals and industry experts.

Learn best practices and technology advances for ESD Control and protection design.



- *EOS/ESD Standards*
- *Tutorials and Seminars*
- *International Symposia*
- *Workshops*



EOS/ESD Association, Inc.

www.esda.org

Visit the meetings and events page for a list of activities!



WHAT: EEEIC 2015 is the 15th annual conference, making it the Europe's one of the largest, longest-running, professional networking and educational event of its kind. EEEIC is an annual energy and environment conference held in 2015 in Rome, Italy, where the delegates make presentations and discuss various issues including clean and renewable energy solutions for protection of our environment. In 2015, for the first time, the conference is fully sponsored by IEEE.

INFORMATION: <http://eeeic.eu>

2015 IEEE International Symposium on Antennas and Propagation Joint CNC/USNC-URSI Meeting

WHEN: 19-25 July 2015

WHERE: Vancouver, British Columbia, Canada

WHAT: The 2015 IEEE AP-S Symposium on Antennas and Propagation and URSI CNC/USNC Joint Meeting - Vancouver 2015 will be held on July 19-25, 2015, at the Westin Bayshore Hotel in Vancouver, British Columbia, Canada. The technical sessions, workshops, and short courses will be coordinated between the two groups to provide a comprehensive and well-balanced program. This meeting is intended to provide an international forum for the exchange of information on state-of-the-art research in antennas, propagation, electromagnetic engineering, and radio science.

INFORMATION: <http://apsursi2015.org>

International Conference on Numerical Electromagnetic Modeling and Optimization for RF, Microwave and Terahertz App. (NEMO) 2015

WHEN: 11-14 August 2015

WHERE: Ottawa, Canada

WHAT: NEMO2015 is a brand new international conference designed to bring together experts and practitioners of computational electromagnetics for RF, microwave and terahertz applications. This conference is the ideal venue to share new ideas on numerical techniques for electromagnetic modeling, propose efficient design algorithms and tools, and anticipate the modeling needs of future technologies and applications.

INFORMATION: <http://nemo-ieee.org>

IEEE International Symposium on Electromagnetic Compatibility 2015 - Dresden

WHEN: 16-22 August 2015

WHERE: Dresden, Germany

WHAT: The 2015 IEEE International Symposium on Electromagnetic Compatibility is a comprehensive event featuring technical seminars and workshops, industry meetings, professional awards, social events, products and services demonstrations, and a companion program.

INFORMATION: www.emc2015.org

IRMMW-THz 2015

WHEN: 24-25 August 2015

WHERE: Hong Kong, China

WHAT: Established in 1974, the International Conference on Infrared, Millimeter, and Terahertz Waves is the oldest and largest continuous forum specifically devoted to the field of ultra-high-frequency electronics and applications. The conference welcomes the sharing of scientific and technical knowledge in the areas and disciplines involving infrared, millimeter and terahertz waves.

INFORMATION: <http://bme.ee.cuhk.edu.hk/thzgroup/irmmw2015/index.html>

Metamaterials 2015

WHEN: 7-12 September 2015

WHERE: Oxford, United Kingdom

WHAT: The Ninth International Congress on Advanced Electromagnetic Materials in Microwaves and Optics – Metamaterials 2015, will comprise a 4-day Conference, and a 2-day Doctoral School. This follows the success of Metamaterials 2007-2014 and continues the traditions of the highly successful series of International Conferences on Complex Media and Metamaterials (Bianisotropics) and Rome International Workshops on Metamaterials and Special Materials for Electromagnetic Applications and TLC. The Congress will provide a unique topical forum to share the latest results of the metamaterials research in Europe and worldwide and bring together the engineering, physics, and material science communities working on artificial materials and their applications from microwaves to optical frequencies.

INFORMATION: <http://congress2015.metamorphose-vi.org>

European Microwave Week 2015

WHEN: 6-11 October 2015

WHERE: Paris, France

WHAT: The European Microwave Week is a five-day event that provides seminars, workshops and discussion groups where attendees can discuss relevant microwave, RF, wireless, defense/security and radar issues with leading manufacturers, researchers and industry bodies. EMW consists of three conferences: The European Microwave Conference (EuMC), the European Microwave Integrated Circuits Conference (EuMIC) and the European Radar Conference (EuRAD).

INFORMATION: www.eumweek.com

EMC Compo 2015

WHEN: 10-13 November 2015

WHERE: Edinburgh, UK

WHAT: The 11th International Workshop EMC Compo 2015 is intended to be a place for researchers from industry and academia to exchange the latest achievements and experiences in integrated circuit-level EMC.

INFORMATION: www.emccompo2015.org

EMC Live Test Bootcamp

WHEN: 12 November 2015

WHERE: Online

WHAT: This is a 1-day, highly focused event for test engineers and electronics engineers alike, dedicated to pre-compliance and compliance testing for EMC. Learn the latest on standards, equipment, setups and test techniques, hosted by *Interference Technology*.

INFORMATION: www.emclive2015.com

World Radiocommunication Conference 2015

WHEN: 2-27 November 2015

WHERE: Austin, Texas, USA

WHAT: The WRC reviews and, if necessary, revises the Radio Regulations, the international treaty governing the use of the radio-frequency spectrum and the geostationary-satellite and non-geostationary-satellite orbits.

INFORMATION: www.itu.int/en/ITU-R/conferences/wrc/2015/Pages/default.aspx

SAVE THE DATE

KEEPING INTERFERENCE AT BAY



EMC&SI 2015

Silicon Valley • March 15-21, 2015

EMC & SI 2015 Symposium will be striving to "Keep Interference at Bay" by providing the most current information, tools and techniques on EMC testing and signal and power integrity.

Register by February 20th to get the Early Bird Discount!

Plan ahead to join your colleagues and experts/innovators in Santa Clara, California for a full week of learning, collaboration and networking with fellow industry peers.

From novice to expert, across all industries and academia, the symposium is the must attend engineering event.

- Attend concurrent **workshops, tutorials and demonstrations** to learn the latest innovations in EMC & Signal Integrity.
- Participate in some of the many **industry and professional meetings** to take your participation to the next level.
- Visit the **Exhibit Hall** with hundreds of booths filled with the latest products, equipment and services.
- Greet old friends, meet new friends, experts, and colleagues at numerous formal and informal **networking functions**.
- **Interns and newly graduated EE/EMC engineers** will have the chance to learn from the more experienced and participate in Young Professionals activities.

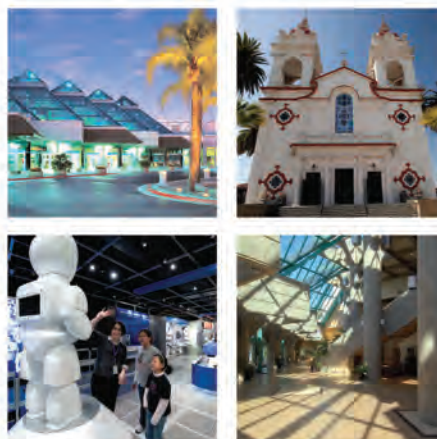

For Registration &
Event Details Visit:
emc2015usa.emcss.org

EXHIBITION - CONFERENCES - ANIMATIONS

4th
edition

Microwave & RF

The Trade show
of radiofrequencies,
microwaves, wireless, EMC
and optical fibre.

April 1 & 2, 2015

**CNIT
Paris la Défense**

www.microwave-rf.com

Organization





Total System Technology[®]

The ideal choice for a complete EMC solution.



Antennas ■ Chambers ■ Systems ■ Test Products

**TDK offers a single vendor solution for all
your EMC testing needs.**

Please contact us for additional information

www.tdkrfsolutions.com

info@tdkrf.com

UNITED KINGDOM

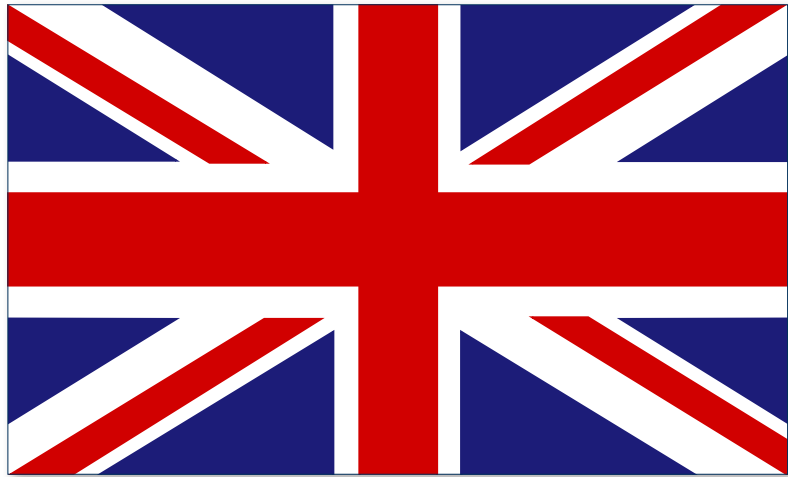

22 PRODUCTS & SERVICES

31 RESOURCES

32 ARTICLES

Applying Stealth Technology to EMC Test Chamber Designs

TOM MULLINEAUX, EMC Engineer, Laird Technologies

Assessing Low Frequency Magnetic Field Exposure in Hybrid and Electric Vehicles

ALASTAIR RUDDLE, LESTER LOW, MIRA Limited

A Winning Team



Success requires a strong team of specialists working together seamlessly; and AR Europe has the best team in the industry. It includes leading experts from a variety of fields all sharing knowledge to provide exceptional value based solutions.

- AR RF/Microwave Instrumentation - RF/Microwave & EMC Broadband Power Amplifiers - www.arworld.us
- MVG-EMC - Anechoic Chamber Technology - www.mvg-emc.com
- AE Techtron - Industrial Amplifiers - www.aetechtron.com
- Gerac - High Voltage Products - www.gerac.com
- Eastern OptX - Delay Lines - www.eastern-optx.com
- AR Modular RF - Military Booster Amplifiers - www.arworld.us
- Remcom - EMC Simulation - www.remcom.com
- FSA - Antennas - www.fsant.de
- Tegam - RF Power Cal Systems - www.tegam.com
- Microrad - Safety Monitors - www.microrad.it
- AV - Power Cycling And Test Systems - www.avinc.com

www.ar-europe.ie

aruksales@arworld.us

+44 1908 282766

ISO 9001:2008
Certified

ar europe

National Technology Park, Ashling Building, Limerick, Ireland • +353 61 504300 • www.ar-europe.ie

In Europe, call ar United Kingdom +44 1908 282766 • ar France +33147917530 • ar Deutschland +49 6101 80270 0 • ar Benelux +31 172 423000

www.arworld.us

Copyright © 2014 AR. The orange stripe on AR products is Reg. U.S. Pat. & TM. Off.



PRODUCTS & SERVICES

1-9

3C Test Ltd.

Silverstone Technology Park, Silverstone Circuit, Northamptonshire NN12 8GX, United Kingdom
+44(0)1327 857500; Fax: +44(0)1327 857747
Pete Sheppard, sales@3ctest.co.uk; www.3ctest.co.uk
Products and Services: Testing

A



A.H. Systems

SystemWare Europe, Cambridgeshire, United Kingdom
+44(0) 1480-478770; Fax: +44(0) 1480-470519
enquiries@sysware-europe.com
www.AHSystems.com
Products and Services: Antennas, Test Instrumentation, Testing



Aaronia

Gewerbegebiet Aaronia AG, Strickscheid, RLP, 54597, Germany
+49(0)6556 93033; Fax: +49(0)6556 93034
Manuel Pinten; mail@aaronia.de
www.aaronia.de
Products and Services: Amplifiers, antennas, cables and connectors, shielding, Test Instrumentation, Testing, Other

Accurate Controls Ltd.

25 Cowley Road, Nuffield Industrial Estate, Poole, Dorset, BH17 0UJ, United Kingdom,
+44(0)1202 678108; Fax: +44(0)1202 670161
Paul Gibbens, pgibbens@accurate-controls.ltd.uk
www.accurate-controls.ltd.uk
Products and Services: Test Instrumentation

AEF Solutions

Unit 46, Thomas Way, Lakesview Business Park, Hersdon, Canterbury, CT3 4JJ, United Kingdom
+44(0)1227 711455; Fax: +44(0)2380 455022
Paul Lawrence, paul@aefsolutions.com
Products and Services: Filters, Cables & Connectors, Surge & Transients, Miscellaneous

Aeroflex Test Solutions

Longacres House, Six Hills Way, Stevenage, SG1 2AN, United Kingdom
+44 1438 742200; Fax: +44 1438 727601
www.aeroflex.com
Products and Services: Test Instrumentation

Agilent Technologies UK Ltd.

5 Lochside Avenue, Edinburgh Park, Edinburgh, EH12 9DJ, United Kingdom
+44 (0)131 452 0200; Fax: +44 (0)131 452 0419
www.agilent.com
Products and Services: Test Instrumentation

Albacom Ltd.

George Buckman Drive, Dundee, DD2 3SP United Kingdom
+44(0)1382 889311; +44(0)1382 810171
Martin Mackin, m.mackin@albacom.co.uk
Products and Services: Amplifiers



Albatross Projects GmbH

Daimlerstraße 17, 89564 Natttheim, Germany
+49 7321 730 500; Fax: +49 7321 730 590
info@albatross-projects.com
www.albatross-projects.com
Products and Services: Shielded Rooms & Enclosures, Anechoic Chambers

Alrad Instruments Ltd.

Alder House, Turnpike Road Industrial Estate, Newbury, Berkshire, RG14 1NS, United Kingdom
+44(0)1635 32630
sales@alrad.co.uk, www.alrad.co.uk
Products and Services: Test Instrumentation

Anritsu EMEA Ltd.

200 Capability Green, Luton, Beds, LU1 3LU, United Kingdom
+44 (0)1582 433280; Fax: +44 (0)1582 731303
salesadministration@anritsu.com
www.eu.anritsu.com
Products and Services: Test Instrumentation, Testing

Ansys UK, Ltd.

First Floor, 8 Bracknell Beeches, Old Bracknell Lane West, Bracknell, Berks, RG12 7BW, United Kingdom
+44 (0) 1344767550; Fax: 44 (0) 1344767551
ukinfo@ansys.com; www.ansys-uk.com
Products and Services: EMC Design Software Applied Coating

Applied Coating Technologies Ltd.

Tipton Road, Tividale Oldbury B69 3HY, United Kingdom
+44 (0)121 557 5324; Fax: +44 (0)121 557 7064
info@aplicoat.com; www.aplicoat.com
Products and Services: Conductive Materials

AQL EMC Limited

16 Cobham Road, Ferndown Industrial Estate, Wimborne, Dorset, BH21 7PG, United Kingdom
+44(0)1202 861175; Fax: +44(0)1202 861176
www.aqlmc.co.uk
Products and Services: Consultancy, Testing



AR United Kingdom Ltd.

Unit 8 TORC MK, Chippenham Drive, Kingston, Milton Keynes, England Bucks MK10 0BZ
+44(0)1908 282766; Fax: +44(0)1908 288249
Mark Reeve, Mreeve@arworld.us; www.aruktd.co.uk
Products and Services: Amplifiers, Antennas, Cables & Connectors, Shielded Rooms & Enclosures, Surge & Transients, Test Instrumentation

Arrow Europe

Arrow Advantage UK, London Road Campus, London Road, Harlow Essex CM179NA United Kingdom
+44 1279 626777; www.arroweurope.com
Products and Services: Ferrites, Cables & Connectors, Power Applications

B

BAE Systems

Faraday Test Centre, Marconi Way, Rochester, Kent. ME1 2XX, United Kingdom
+44(0)1634205155
Faraday.test@baesystems.com
www.baesystems.com/faradaytestcentre
Products and Services: Testing

Bfi OPTiLAS Ltd.

Mill Court, Wolverton Mill South, Milton Keynes MK 12 5EU, United Kingdom
+44(0)1908 326326; Fax: +44(0)1908 221110
sales.uk@bfioptilas.com
www.bfioptilas.co.uk
Products and Services: Shielding, Testing

Blackwood Labs

8 Woodfieldside Business Park, Pontllanfraith, Blackwood, NP12 2DG, United Kingdom
+44(0)1495 229219
test@blackwood-labs.co.uk; www.blackwood-labs.co.uk
Products and Services: Testing

Brand-Rex Ltd.

Viewfield Industrial Estate,
Glenrothes, Fife., KY6 2RS United Kingdom
+44(0)1592 772124; Fax: +44(0)1592 775314
Audrey O'Brien, aobrien@brand-rex.com
www.brand-rex.com
Products and Services: Cables & Connectors

BRE Ltd.

Bucknalls Lane,
Watford, WD25 9XX United Kingdom
+44(0)1923 664000
enquiries@bre.co.uk; www.bre.co.uk
Products and Services: Testing

Brian Jones

89 Widney Road, Knowle
Solihull B93 9EA, United Kingdom
+44(0)1564 773319
emc@brianjones.co.uk
Products and Services: EMC Consultant specializing in standards and regulations

Bulgin

Melville Court, Spilsby Road,
Romford, Essex, United Kingdom, RM3 8SB
+44(0)1708 343800
europe@elektron-technology.com; www.bulgin.co.uk
Products and Services: Filters

C

Cabletec ICS Ltd.

Sunnyside Road, Weston-super-Mare, North Somerset,
BS23 3PZ, United Kingdom
+44(0)1934 424900; Fax: +44(0)1934 636632
Karen French, sales@cabletec.com
www.cabletec.com
Products and Services: Shielding

Caltest Instruments Ltd.

4 Riverside Business Centre, Walnut Tree Close,
Guildford, Surrey GU1 4UG, United Kingdom;
+44 (0) 1483 302 700; Fax: +44 (0) 1483 300 562;
info@caltest.co.uk; www.caltest.co.uk
Products and Services: Test Instrumentation

Carlisle Interconnect Technologies

United Kingdom;
+44-7817-731-000;
Andy Bowne, Andy.Bowne@carlisleit.com
www.CarlisleIT.com
Products and Services: Filters

CASS Industries Ltd.

Blackbrook Trading Estate Weybrook Road, Levenshulme,
Manchester, M19 2QD United Kingdom;
+44(0)1614 424200; Fax: +44(0)1614 424283
www.cassindustries.com
Products and Services: Testing

CCQS UK Ltd.

Level 7, CEC Westgate, Westgate House,
Westgate Road, London, W5 1YY, United Kingdom;
+44(0)208991 3488; info@ccqs.co.uk; www.ccqsuk.co.uk
Products and Services: Certification Services

Cherry Clough Consultants

9 Bracken View, Brocton, Stafford, Staffs,
ST17 0TF, United Kingdom
+44(0)1785 660247
Keith Armstrong; keith.armstrong@cherryclough.com
www.cherryclough.com
Products and Services: Training, Seminars & Workshops, Design and Management Consultancy

Cobham Microwave

148 Stocks Lane, Bracklesham Bay, Chichester,
West Sussex, PO20 8NT United Kingdom
+44(0)1243 670711; Fax: +44(0)1243 672907
Dean Terrett, Key Account Manager
DeanTerrett@cobham.com
www.cobham.com/microwave
Products and Services: Antennas, Cables & Connectors, Filters, Shielded Rooms & Enclosures

Comtest Engineering bv

Industrieweg 12, 2382 NV Zoeterwoude, The Netherlands
+31-71 5417531; Info@comtest.eu; www.comtest.eu
Products and services: Anechoic chambers, Reverberation chambers, RF shielded rooms & doors, Hybrid & Microwave absorbers.

Conformance Services Ltd.

24 Tidnock Avenue, Congleton,
Cheshire, CW12 2HW United Kingdom
+44(0)1260 270729; Fax: +44(0)1260 270729;
enquiries@conformance-services.com;
www.conformance-services.com
Products and Services: Testing

Coreshield

St. Margaret's School, Gosfield Hall Park,
Gosfield, Halstead, Essex, CO9 1SE, United Kingdom
+44(0)1787 472134; Fax: +44(0)1787 473589
info@coreshield.eu; www.coreshield.eu
Products and Services: Shielding Communications & Power

Communications & Power Industries Europe Ltd.

Surrey, England
+44 (1932) 256 930; Fax: +44 (1932) 241 271;
Tony Johns, tony.johns@cpii.com
Donna Crittenden; donna.crittenden@cpii.com
www.cpii.com
Products and Services: Amplifiers, Microwave Power

Cranage EMC & Safety

Market Drayton, Shropshire, United Kingdom;
+44(0)1630 658568; Fax: +44(0)1630 658921
info@cranage.co.uk; www.cranage.co.uk
Products and Services: Testing Labs

Cre8 Associates Ltd.

Bruntingthorpe Proving Ground, Bath Lane,
Lutterworth, Leicestershire, LE17 5QS, United Kingdom
+44(0)1162 479787
enquiries@cre8-associates.com
www.cre8-associates.com
Products and Services: Cables & Connectors, Filters, Testing

CST UK Ltd.

Strelley Hall, Main St., Strelley, Nottingham, NG8 6PE
United Kingdom
+44 115 9061 120; Fax: +44 115 9061 115
info@uk.cst.com
Products and Services: Testing, Antennas, Shielding, Cable, Software, Plugs

D

DEM Manufacturing

Deltron Emcon House, Hargreaves Way, Sawcliffe
Industrial Park, Scunthorpe, North Lincolnshire
DN15 8RF United Kingdom
+44(0)1724 273200; Fax: +44(0)1724 280353
Diane Kilminster; sales@cabletec.com www.dem-uk.com
Products and Services: Filters, Surge & Transients

Dexter Magnetic Technologies Europe, Ltd.

Unit 12, Tavistock Industrial Estate, Ruscombe Park,
Twyford, Berkshire RG10 9NJ, United Kingdom
+44(0)1189 602430; Fax: +44(0)1189 602431
info@dextermag.com; www.dextermag.com
Products and Services: Ferrites, Shielding, Surge & Transients

D+M Systems and Test Ltd.

Icon House, 3 Icen Court, Icknield Way
Letchworth Garden City, Herts, SG6 1TN, United Kingdom
+44 (0) 1462 650620; Fax: +44 (0) 1462 650622
info@dplum.co.uk
Product and Services: Amplifiers, Antennas, Shielded Enclosures, Repair & Calibration, Transient Generators, Probes, Pulse/Spike Generators, Line Impedance/simulation Networks

Dutch Microwave Absorber Solutions

Industrieweg 12, Zoeterwoude, 2382 NV NL
+31-71-5012526
Bas de Groot; BkdeGroot@dmas.eu; www.dmas.eu
Products and Services: Microwave Absorbers

E

Electromagnetic Testing Services Ltd.

Pratts Fields, Lubberhedges Lane, Stebbing, Essex, CM6
3BT United Kingdom
+44(0)1371 856061; Fax: +44(0)1371 856144
www.etsemc.co.uk
Products and Services: Testing



Electronic Test & Calibration Ltd.

Caddsdow Industrial Park, Clovelly Road, Bideford,
EX393DX, United Kingdom
+44(0)1237 423388; Fax: +44(0)1237 423434
test@etcal.co.uk; www.etcal.co.uk
Products and Services: Antennas, Calibration, Testing, Training

Electrostatic Solutions Ltd.

13 Redhill Crescent, Bassett, Southampton,
Hampshire, SO16 7BQ, United Kingdom
+44 (0)2380 905600
Dr. Jeremy Smallwood; enq2006@electrostatics.net
www.static-sol.com/index.htm
Products and Services: Consultancy

Elmac Services

Chichester, West Sussex, United Kingdom
consult@elmac.co.uk; www.elmac.co.uk
Products and Services: Consultancy, Training



EM Test AG

Frequensys Ltd., 10 Abbey Court, Fraser Road, MK44
3WH Bedford, United Kingdom; +44 1142 353 507;
Fax: +44 1234 831 998; info@frequensys.co.uk; www.frequensys.co.uk
Products and Services: Innovative test- and measurement systems for conducted immunity tests, ESD, transients, automotive, harmonics & flicker, AC/DC-sources, safetytest systems, accredited calibrations, seminars, workshops, consulting

EMC Consultants Ltd.

Stebbing Hall, Lubberhedges Lane, Stebbing, Essex, CM6 3BU United Kingdom
+44(0)1371 856964; Fax: +44(0)1371 856984
info@emc-consultants.co.uk
http://emc-consultants.co.uk
Products and Services: Consultancy

EMC Hire Ltd.

Unit 1, Ivel Road, Shefford, Bedfordshire, SG17 5JU United Kingdom
+44(0)1462 817111; Fax: +44(0)1462 819564
www.emchire.co.uk
Products and Services: Test Instrumentation

EMC Partner UK Ltd.

1A Golf Link Villas, The Common, Downley, High Wycombe, HP13 5YH, Buckinghamshire, United Kingdom
+44(0)1494 44 42 55; Fax: +44(0)1494 44 42 77
David Castle, sales@emcpartner.co.uk
www.emcpartner.co.uk
Products and Services: Surge & Transients, Test Instrumentation

EMC Resources Ltd.

Willow House, Greenrig Road, Hawksland, Lanark, ML11 9QA United Kingdom
+44(0) 141 4161 663
info@finda-training-course.co.uk
www.finda-training-course.co.uk
Products and Services: Consultancy

EMC Solutions Ltd.

Unit 6, Century Park, Starley Way, Solihull, West Midlands, B37 7HF United Kingdom
+44(0)1217 822705
www.emcsolutionsltd.com
Products and Services: Filters, Testing

ERA Technology Ltd.

Cleeve Road, Leatherhead, Surrey, KT22 7SA, United Kingdom
+44(0)1372 367030
www.cobham.com/technicalservices
Products and Services: Consultancy

ETC Ltd.

Caddsdow Industrial Park Clovelly Road, Bideford, EX39 3DX United Kingdom
+44(0)1237 423388; Fax: +44(0)1237 423434
info@etcal.co.uk; www.etcal.co.uk/emc_cont.htm
Products and Services: Testing



ETS - Lindgren Ltd.

Unit 4 Eastman Way, Pin Green Industrial Area, Stevenage, Hertfordshire, SG1 4UH, United Kingdom
+44(0)1438 730700; Fax: +44(0)1438 730750
uk@ets-lindgren.com; www.ets-lindgren.com
Products and Services: Antennas, Ferrites, Filters, Shielded Rooms & Enclosures, RFI/EMI Signal Generators, Test Instrumentation, Miscellaneous

European EMC Products

Unit 7-9, Saffron Business Centre Elizabeth Way, Saffron Walden, Essex, CB10 2BL United Kingdom
+44(0)1799 523 073; Fax: +44(0)1799 521 191
info@euro-emc.co.uk; www.euro-emc.co.uk
Products and Services: Shielding

Euroquartz Ltd.

Blacknell Lane, Crewkerne, Somerset TA18 7HE, United Kingdom
+44(0)1460 230000; Fax: +44(0)1460 230001
John Dale, info@euroquartz.co.uk
www.euroquartz.co.uk
Products and Services: Filters



Fair-Rite Products Corp.

Dexter Magnetic Technologies Europe, Ltd., Unit 12, Tavistock Industrial Estate, Ruscombe Park, Twyford, Berkshire RG10 9NJ United Kingdom
+44(0) 1189 602430; Fax: +44(0) 1189 602431
info@dextertermag.com
Schaffner Ltd., Ashville Way, Molly Millars Lane, Wokingham, Berkshire RG41 2PL United Kingdom
+44 118 977 0070; Fax: +44 118 979 2969
uksales@schaffner.com; www.Fair-Rite.com
Products and Services: Antennas, Ferrites



Glenair UK Ltd.

40 Lower Oakham Way, Mansfield, NG18 5BY, United Kingdom
+44(0)1623 638154; Fax: +44(0)1623 638111
Jane Moss, jmoss@glenair.co.uk; www.glenair.co.uk
Products and Services: Cables & Connectors

Global EMC

Prospect Close, Lowmoor Road Industrial Estate, Kirby-in-Ashfield, NG17 7LF United Kingdom
+44(0)1623 755539; Fax: +44(0)1623 755719
www.globalemc.co.uk
Products and Services: Shielding, Testing

Globec (UK) Ltd.

Unit 15, Shrivenham Hundred Business Park, Watchfield, Oxfordshire, SN6 8TZ, United Kingdom
+44(0)1793 780790; Fax: +44(0) 1793 780776
Peter Harris, peterh@globec.co.uk
www.globec.co.uk/emc/filters/filter7.html
Products and Services: Cables & Connectors, Filters

Gowanda Electronics

ACAL BFI UK Ltd.
Mill Court, Wolverton Mill South, Milton Keynes, Buckinghamshire, MK12 5EU, United Kingdom
+44 1908 326326; Fax: +44 1908 221110
info.uk@bfiopitilas.com; www.bfiopitilas.com
Products and Services: Inductors

Charcroft Electronics

Dol-y-Coed, Llanwrtyd Wells, Powys, LD5 4TH, United Kingdom
+44 01591 612242; Fax: +44 01591 612005
lewis.charlton@charcroft.com
www.charcroft.com
Products and Services: Inductors



Habia Cable Inc.

Unit 10 Short Way, Thornbury Industrial Estate, Thornbury, Bristol, BS35 3UT, United Kingdom
+44(0)1454 41 25 22
www.habia.com
Products and Services: Cables & Connectors

Harwin

Fitzherbert Road, Farlington, Portsmouth, PO6 1RT, Hants, United Kingdom
+44(0)2392 314545
www.harwin.com
Products and Services: Cables & Connectors

HITEK Electronic Materials Ltd.

15 Wentworth Road, South Park Industrial Estate, Scunthorpe, Lincs, DN17 2AX, United Kingdom
+44(0)1724 851678; Fax: +44(0)1724 280586
John Terry, sales@hitek-ltd.co.uk
www.hitek-ltd.co.uk
Products and Services: Conductive Materials

Horiba Instruments UK Service Center

Kyoto Close, Summerhouse Road, Moulton Park, Northampton, NN3 6FL United Kingdom
+44(0)1604 542500
www.horiba.com
Products and Services: Testing

HTT (UK) Ltd.

Unit 6 Northend Industrial Estate, Bury Mead Road, Hitchin, SG5 1RT, United Kingdom
+44(0)1462 486866
Roland Brunisholz, sales@httuk.co.uk; www.httuk.co.uk
Products and Services: Test Instrumentation, Testing

Hursley EMC Services

Unit 16, Brickfield Lane Chandlers Ford, Eastleigh, Hampshire, SO53 4DP United Kingdom
+44(0)2380 271111; Fax: +44(0)2380 271144
sales@hursley-emc.co.uk; www.hursley-emc.co.uk
Products and Services: Consultancy, Testing



RF/Microwave Amplifiers

IFI - Instruments for Industry

DM Systems and Test Ltd., 60 Wilbury Way Hitchin Hertfordshire SG4 0/A, United Kingdom
+44 (0) 1462 477277; Fax +44 (0) 1462 428995
Brian Epton; brian.epton@dplum.co.uk; Graham Howard, graham.howard@dplum.co.uk; Mick Keryell, mike.keryell@dplum.co.uk
Products and Services: High Power Microwave and RF Amplifiers (Tetrode Tubes, Solid State and TWT) up to 40 GHz

Instrument Plastics Ltd.

Unit 35, Kings Grove Industrial Est, Maidenhead, Berkshire, SL6 4DP, United Kingdom
sales@instrumentplastics.co.uk
www.instrumentplastics.co.uk
Products and Services: Shielding

WHO SAYS YOU CAN'T HAVE IT ALL?

and with next-day, on-time delivery

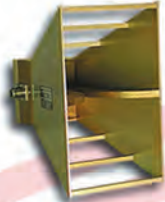

DRG Horns
170 MHz - 40 GHz
6 Models

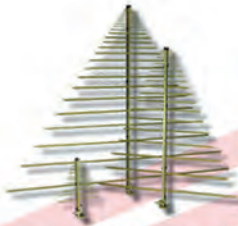

Log Periodics
80 MHz - 7 GHz
13 Models



Preamplifiers
20 MHz - 40 GHz
8 Models



Low Loss Cables
DC - 40 GHz
4 Models



Biconicals
20 MHz - 330 MHz
5 Models



BiLogicals
25 MHz - 7 GHz
8 Models



All in one small package



H-Field Rods
100 Hz - 30 MHz
4 Models



Probes
20 Hz - 1 GHz
16 Models



Standard Gain Horns
1 GHz - 40 GHz
9 Models



Tripods and Accessories

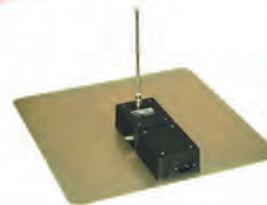

Monopoles
100 Hz - 60 MHz
5 Models



Loops
20 Hz - 30 MHz
7 Models

You Can Have It All when it comes to EMC/EMI testing. A.H. Systems is proud to bring you exciting new products, and many reliable favorites for your evaluation and compliance applications. Our antennas are unique and distinctive with broadband frequency ranges between 20 Hz up to 40 GHz. This enables us to specialize in various sales, rentals and, re-calibrations of test Antennas throughout the world. To view our products and get quick answers to your questions, access our comprehensive online catalog. Search for various information about product descriptions, typical AF plots, VSWR, power handling capabilities and links to product data sheets. Or simply request a catalog be sent to you. Not only have we been developing EMI Antennas for over 30 years, we also have organized worldwide sales representation. You can find your local knowledgeable representative in over 27 countries via our website. For quality products, excellent service and support with next-day, on-time delivery.

Antennas...

And Kits too.



Innovation

Quality

Performance

Phone: (818)998-0223 ♦ Fax (818)998-6892
www.AHSystems.com?IT

A.H. Systems



J

J. M. Woodgate and Associates

3 Bramfield Road East, Rayleigh, Essex, SS6 8RG, United Kingdom
+44(0)1268 747839; Fax: +44(0)1268 777124
jmw@jmwa.demon.co.uk; www.jmwa.demon.co.uk
Products and Services: Consultancy

K



Kemtron Ltd.

19-21 Finch Drive, Springwood Industrial Estate, Braintree, Essex, CM7 2SF, United Kingdom
+44(0)1376 348115; Fax: +44(0)1376 345885
info@kemtron.co.uk; www.kemtron.co.uk
Products and Services: RFI/EMI Shielding gaskets and components

KnitMesh Technologies

Greenfield, Holywell, Flintshire, North Wales, CH8 9DP United Kingdom
+44(0)1352 717600; Fax: +44(0)1352 714909
Colin Barnes; colin.barnes@knitmeshtechologies.com
www.knitmeshtechologies.com
Products and Services: Shielding, Conductive Materials

KTl (TracGlobal)

Unit E, South Orbital, Tracking Park, Hedon Road, Hull, HU9 1NJ United Kingdom
+44(0)1482 801801
www.ktl.com
Products and Services: Testing

L

Langer EMV-Technik GmbH

APC-Novacom, Novalis Place, Deepdale Enterprise Park, Deepdale Lane, Nettleham, Lincoln, LN2 2LL, United Kingdom
+44 1522 751136; Fax: +44 1522 754408
sales@apc-novacom.co.uk
www.apc-novacom.co.uk; www.langer-emv.de
Products and Services: Test Instrumentation

Laplace Instruments Ltd.

Tudor House, Grammar School Road, North Walsham, Norfolk NR28 9JH, United Kingdom
+44 (0) 16 92 40 20 70; Fax: +44 (0) 16 92 40 49 10;
tech@laplace.co.uk
www.laplaceinstruments.com
Products and Services: Amplifiers, Antennas, Shielded Rooms & Enclosures, Test Instrumentation

Link Microtek Ltd.

High Point, Church Street, Basingstoke, Hampshire, RG21 7QN, United Kingdom
+44(0)1256 355771; Fax: +44(0)1256 355118
Hugo Bibby, sales@linkmicrotek.com
www.linkmicrotek.com
Products and Services: Test Instrumentation

M

M. Buttkeireit Ltd.

Unit 2, Britannia Road, Ind. Est. Sale Cheshire, M33 2AA, United Kingdom
+44(0)1619 695418
info@buttkeireit.co.uk
Products and Services: Cables & Connectors

Magnetic Shields Ltd.

Headcorn Road, Staplehurst, Kent TN12 ODS United Kingdom
+44(0)1580 891521; Fax: +44(0)1580 893345
enq@magneticshields.co.uk
www.magneticshields.co.uk
Products and Services: Shielding

MDL Technologies Ltd.

Unit 11, Devonshire Business Centre, Works Road, Letchworth, Herts, SG6 1GJ, United Kingdom
+44(0)1462 431981; Fax: +44(0)5603 152515
www.mdltechnologies.co.uk
Products and Services: Testing

Mead Testing Ltd.

Unit 25 Mead Industrial Park River Way, Harlow, Essex, CM20 2SE United Kingdom
+44(0)1279 635864; Fax: +44(0)1279 635874
www.meadtest.com
Products and Services: Testing

Mentor Graphics Mechanical Analysis Div.

81 Bridge Road, Hampton Court, Surrey, KT8 9HH, United Kingdom
+44(0)2084 873000; Fax: +44(0)2084 873001
John Parry, Research Manager
john_parry@mentor.com
www.mentor.com/products/mechanical
Products and Services: Thermal Software and Characterization Hardware

METECC

179 Junction Road, Burgess Hill, West Sussex, RH15 0JW, United Kingdom
+44(0)7725 079956
Peter Metcalfe, peter@metecc.eu; www.metecc.eu
Products and Services: Testing, Training



RF/Microwave Amplifiers

MILMEGA Ltd.

MDL Technologies Limited, Unit 11, Devonshire Business Centre, Works Road, Letchworth Hertfordshire SG6 1GJ, United Kingdom
+44 0 1462 431981; Fax: 0044 0 560 315 2515
sales@mdltechnologies.co.uk
www.mdltechnologies.co.uk; www.milmega.com
Products and Services: High Power RF and Microwave solid state amplifiers.
Frequency range 80MHz up to 6GHz, with output powers to 1kW

MIRA Ltd.

Watling Street Nuneaton, Warwickshire, CV10 0TU, United Kingdom
+44(0)2476 355576; Fax: +44(0)2476 358576
www.mira.co.uk
Products and Services: Testing, Training

MPE Ltd.

Hammond Road, Knowsley Industrial Park, Liverpool, Merseyside, L33 7UL, United Kingdom
+44(0)1516 329100; Fax: +44(0)1516 329112
John Jephcott, sales@mpe.co.uk
www.mpe.co.uk
Products and Services: Filters

Murata Electronics UK

Oak House, Ancells Road, Ancells Business Park, Fleet, Hampshire, GU51 2QW, United Kingdom
+44(0)1252 8111666
Aya Tonooka, Marketing Officer UK
ayatonooka@murata.co.uk; www.murata-europe.com
Products and Services: Amplifiers, Ferrites, Filters, Surge & Transients

N



Narda Safety Test Solutions S.r.l. Teseq Ltd.

5 Ashville Way - Molly Millars Lane Wokingham - Berkshire RG41 2PL - UK
Tel: +44 845 074 0660, Fax: +44 845 074 0656
www.teseq.com/en/index.php, www.narda-sts.com/en/
Products and Services: RF Testing, Safety

Noratel UK Ltd.

7 George House Princes Court, Beam Heath Way, Nantwich, CW5 6GD United Kingdom
+44(0)1270 611368
info@noratel.co.uk; www.toroid.co.uk
Products and Services: Ferrites, Surge & Transients

O

Optical Filters Ltd.

Unit 13 & 14, Thame Park Business Centre, Wenman Road, Thame, Oxon, United Kingdom
+44(0)1844 260377; Fax: +44(0)1844 260355
www.opticalfilters.co.uk
Products and Services: Filters, Shielding

Oxley Group Ltd.

Priory Park, Ulverston, Cumbria, LA12 9QG, United Kingdom
+44(0)1229 582621; Fax: +44(0)1229 585090
Mark Johnson; sales@oxleygroup.com
www.oxleygroup.com
Products and Services: Cables & Connectors, Ferrites, Filters, Shielding, Surge & Transients, Testing

P

P & P Technology Ltd.

Finch Drive, Springwood, Braintree, Essex, United Kingdom
+44(0)1376 550525; Fax: +44(0)1376 552389
www.p-p-t.co.uk
Products and Services: Conductive Materials, Die Cut Shielding Material, EMI Gaskets, Shielding

Peak Electromagnetics

139 Bank Street, Macclesfield, Cheshire, SK11 7AY United Kingdom
+44(0)1625 269808
sales@peak-em.co.uk; www.peak-em.co.uk
Products and Services: Consultancy

Antennas

1Hz to 18GHz



NEW



Magnetic Tracking Antennas

9 kHz - 400 MHz

- Offers very high gain accuracy allowing accurate field strength tests
- Extremely compact and lightweight, fits to any Spectrum Analyzer or Power Meter
- Available as passive and active Versions with max. 40dB Pre-Amplifier
- Offers a high directivity to pin point signal(s)



Biconical EMC Antennas

20 MHz - 3 GHz

- Perfect for EMC measurements (CISPR, EN55011 etc.)
- Suitable for field-strength and EMC measurements due to high precision
- Can be used in the lab and for open-field application
- Coverage of various mobile radio frequency ranges



E & H Near Field Probe Sets

1 Hz - 9 GHz

- 5 different probes (E&H) for field-strength and EMC measurements
- Active or passive version available
- Gain rises very linear with frequency which offers high accuracy
- Can be driven by a signal source to generate fields

NEW



High Power Antennas

700 MHz - 18 GHz

- Supports very high input power of max. 500W (peak)
- Gain rises with frequency up to 17dBi
- Suitable for immunity tests and EMC pre- and full-compliance tests
- Including extensive, specific calibration data



Directional Antennas

380 MHz - 18 GHz

- Perfect for detecting even weakest signals
- Wide range for different applications available
- Ultra high gain up to 45dBi
- Special designed radome for perfect antenna protection

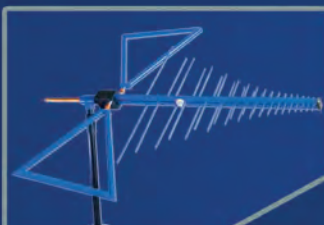

Pre-Compliance Test-Antennas

20 MHz - 6 GHz

- Meets the latest EMI/EMC standards from 2011 up to 6GHz
- Very high accuracy to be used as a reference antenna
- Very high gain over the total frequency range
- Suitable for immunity measurements

MADE IN GERMANY

AARONIA AG

WWW.AARONIA.DE

PGMC Ltd.

8 Cudworth Mead, Hedge End, Southampton, SO30 4SP, United Kingdom
+44 (0) 20 7193 1730; Mobile: +44 (0) 7713 628173
p.garcia@ieee.org
Products and Services: Product compliance

PPI (Power Products International) Ltd.

Commerce Way, Edenbridge, Kent, TN8 6ED, United Kingdom
+44(0)1732 866424; Fax: +44(0)1732 866399
Geoff Robinson; gkrobinson@ppi-uk.com
www.ppi-uk.com
Products and Services: Filters

PPM (Pulse Power and Measurement) Ltd.

65 Shrivensham Hundred Business Park, Watchfield, Swindon, Wiltshire, SN6 8TY, United Kingdom
+44(0)1793 784389; Fax: +44(0)1793 784391
Philip Surman, psurman@ppm.co.uk;
www.point2point.co.uk
Products and Services: Antennas, Cables & Connectors, Test Instrumentation, Testing

Precision Micro Ltd.

11 Vantage Way, Erdington, Birmingham, B24 9GZ, United Kingdom
+44 121 380 0100; Fax: +44 121 749 4157
www.precisionmicro.com
Products and Services: Shielding

Q

Q-par Angus Ltd.

Barons Cross Laboratories, Leominster, Herefordshire, HR6 8RS, United Kingdom
+44(0)1568 6121381; Fax: +44(0)1568 616373
Rob Lowther; sales@q-par.com; www.q-par.com
Products and Services: Antennas, Testing, Miscellaneous

QinetiQ

CodyTechnology, Park 1005, Ively Road, Farnborough, Hampshire, GU14 0LX, United Kingdom
+44 (0)1252 392000; Fax: +44 (0)1252 393399
www.qinetiq.com
Products and Services: Testing

R



Radius Power

Wavelength Electronics Limited
Kent Innovation Centre, Broadstairs Kent, CT10 2QQ UK
+0044 1843 609380; Fax: +0044 1843 609384
Paul Glover; sales@wavelengthelectronics.co.uk
Products & Services: EMI/EMC/RFI Filters

Rainford EMC Systems

St. Helens Merseyside, United Kingdom
+44(0)1942 296190
www.rainfordemc.com
Products and Services: Shielding

Rasmi Electronics Ltd.

Morrison Road, Annfield Plain, Stanley, Durham, DH9 7RX, United Kingdom
+44(0)1207 291300
Dr. Surendra, sales@rasmi.com; www.rasmi.com
Products and Services: Antennas, Filters, Shielded Rooms & Enclosures

RFI Global Services Ltd.

Unit 3 Horizon, Wade Road, Kingsland Business Park, Basingstoke, Hampshire, RG24 8AH United Kingdom
+44 (0)1256 312000
www.rfi-global.com
Products and Services: Testing

Richard Marshall Laboratories

30 Ox Lane, Harpenden, Herts, AL5 4HE, United Kingdom
+44(0)1582 460815
richard.marshall@iee.org; www.design-emc.co.uk
Products and Services: Consultancy

Rittal Ltd.

Braithwell Way, Hellaby Industrial Estate, Hellaby, Rotherham, South Yorkshire, S66 8QY United Kingdom
+44(0)1709 704000
information@rittal.co.uk; www.rittal.co.uk
Products and Services: Shielded Rooms & Enclosures

RN Electronics Ltd.

Arnolds Court, Arnolds Farm Lane, Brentwood, Essex CM13 1UT United Kingdom
+44(0)1277 352219; Fax: +44(0)1277 352968
Paul Darragh, paul@RNelectronics.com
www.rnelectronics.com
Products and Services: Testing



Rohde & Schwarz UK Ltd.

Ancells Business Park Fleet, Hampshire GU51 2UZ
+44 (0) 1252 818 888; Fax +44 (0) 1252 811 447
contact.uk@rohde-schwarz.com www.rohde-schwarz.co.uk; www.rohde-schwarz.co.uk/surf-in
Products and Services: EMC Test Equipment and Accessories; Broadband Amplifiers; EMC Test Software; Turnkey Test System Solutions

Roxburgh EMC

Deltron Emcon House, Hargreaves Way, Sawcliffe Industrial Park, Scunthorpe, North Lincolnshire, DN15 8RF, United Kingdom
+44(0)1724 273200; Fax: +44(0)1724 280353
Diane Kilminster; dkilminster@dem-uk.com
www.dem-uk.com/roxburgh
Products and Services: Filters, Shielded Rooms & Enclosures, Surge & Transients

RS Coatings Ltd.

Unit 10, Britannia Way, Britannia Enterprise Park, Lichfield, Staffordshire, WS14 9UY
+44 01543 410 771; Fax: +44 01543 414 977
rscgroup@btconnect.com
www.rscoatings.com
Products and Services: Shielding

S

Schaffner Ltd.

5 Ashville Way, Molly Millars Lane, Wokingham, Berkshire RG41 2PL, United Kingdom
+44(0)1189 770070; Fax: +44(0)1189 792969
uksales@schaffner.com; www.schaffner.com
Products and Services: Filters



Schlegel Electronic Materials

Kemtron Limited, 19-21 Finch Drive, Springwood Industrial Estate, Braintree, Essex, CM7 2SF, United Kingdom
+44(0)1376 348115; Fax: +44(0)1376 345885
David Wall, dbw@kemtron.co.uk
www.kemtron.co.uk
Products and Services: Conductive Materials, Shielding

Sematron UK Ltd.

Sandpiper House, Aviary Court, Wade Road, Basingstoke, Hampshire, RG24 8GX, United Kingdom
+44(0)1256 812222; Fax: +44(0)1256 812666
Glenn Toal, gtoal@sematron.com; www.sematron.com
Products and Services: Cables & Connectors, Test Instrumentation

Slater Plastics

Unit 7, Hanborough Business Park Lodge Road, Long Hanborough, Oxon, OX8 8LG United Kingdom
+44(0)1785 213861; Fax: +44(0)1785 243204
info@slaterplastics.com; www.slaterplastics.com
Products and Services: Filters, Shielding, Test Instrumentation

Sulis Consultants Ltd.

Mead House, Longwater Road, Eversley, Hampshire, RG27 0NW, United Kingdom
+44(0)7946 624317
Charlie Blackham, charlie@sulisconsultants.com
www.sulisconsultants.com
Products and Services: Product Approvals, CE Marking

Suppression Devices

Unit 8 - York St Business Centre, Clitheroe, Lancashire, BB7 2DL, United Kingdom
+44(0)1200 444497
Campbell Barker, sales@suppression-devices.com
http://suppression-devices.com
Products and Services: Filters

Swift Textile Metalizing LLC

001 860 243 1122 Fax: 001 860 243 0848
Paul Hebert, phebert@swift-textile.com
www.swift-textile.com
Products and Services: Electrically Conductive and Reflective Metalized Fabrics; EMI and RF Shielding; Static Discharge Applications

Syfer Technology Ltd.

Old Stoke Road, Arminghall, Norwich, Norfolk, NR14 8SQ, United Kingdom
+44(0)1603 723310; Fax: +44(0)1603 723301
sales@syfer.co.uk; www.syfer.com
Products and Services: Filters

T

T C Shielding, Ltd.

Unit 2, Ashburton Industrial Estate Ross on Wye, Herefordshire, HR9 7BW United Kingdom
+44(0)1989 563941
info@tcshielding.com; www.tcshielding.com
Products and Services: Shielding

TBA Electro-Conductive Products

Rooley Moor Road, PO Box 56, Rochdale, Lancashire, OL12 7E4, United Kingdom
+44(0)1706 647718; Fax: +44(0)1706 646170
www.tbaecp.co.uk
Products and Services: Conductive Materials, Shielding, Surge & Transients

TDK Electronics UK

Summit House, London Road, Bracknell, Berkshire RG12 2HX, United Kingdom
+44-(0)1344-381 515; info@tdkrf.com
www.tdkrf.com
Products and Services: Antennas, Filters, Software, Testing services

Tecan Ltd.

Tecan Way, Weymouth, Dorset DT4 9TU United Kingdom;
+44(0)1305 765432; Fax: +44(0)1305 780194
www.tecan.co.uk
Products and Services: Shielding

Tech-Etch, Inc.

TBA Electro Conductive Products, P.O. Box 56, Rooley Moor Road, Rochdale, Spotland, Lancs. OL12 7EY, United Kingdom
+44(0)1706 647718; Fax: +44(0)1706 646170;
davidhurst@tbaecp.co.uk; www.tech-etich.com
Products and Services: Conductive Materials, Shielding

Teledyne Reynolds

Navigation House, Canal View Road, Newbury, Berkshire, RG14 5UR, United Kingdom
+44 (0) 1635 262200
Olivier Dilun, Southern Europe regional sales manager; odilun@teledyne.com
www.teledynereynolds.co.uk
Products and Services: Cables & Connectors

Telonic Instruments Ltd.

Toutley Industrial Estate, Toutley Road, Wokingham, RG41 1QN, United Kingdom
+44(0)1189 786911
Bob Lovell, info@telonic.co.uk; www.telonic.co.uk
Products and Services: Filters, Test Instrumentation



Advanced Test Solutions for EMC

Teseq Ltd.

Teseq Ltd., Ashville Way, Molly Millars Lane, Wokingham, Berkshire RG41 2PL; +44 (0) 8540 740 660; Fax: +44 (0) 845 074 0656; uksales@teseq.com; www.ametek-cts.com

Products and Services: Amplifiers (RF & Microwave), Antennas, Automotive Systems, Conducted RF immunity, Conducted Surge & Transients, ESD, Harmonics & Flicker, GTEM cells, RF Immunity Systems, RF Emission Systems, RF Test software, Calibration & Service

The Lighting Association Laboratories

Stafford Park 7, Telford, Shropshire, TF3 3BQ, UK
+44(0)1952 290905; Fax: +44(0)1952 290906;
lab@lightingassociation.com
www.lightingassociation.com
Products and Services: Surge & Transients

Thurlby-Thandar Instruments (TTI)

Glebe Road, Huntingdon, Cambridgeshire, PE29 7DR, United Kingdom
+44(0)1480 412451
www.tti-test.com
Products and Services: Test Instrumentation, Testing

Tioga Ltd.

St Thomas House, Mansfield Road, Derby, DE1 3TN, United Kingdom
+44(0)1332 360884; Fax: +44(0)1332 360885
Angela Bond; angela@tioga.co.uk
www.tioga.co.uk
Products and Services: Testing

TMD Technologies Ltd.

Swallowfield Way, Hayes, Middlesex UB3 1DQ, United Kingdom
+44(0)2085 735555; Fax: +44(0)2085 691839;
wecare@tmd.co.uk; www.tmd.co.uk
Products and Services: Amplifiers, Antennas, Filters, Test Instrumentation

TRAC Global, Ltd.

100 Frobisher Business Park, Leigh Sinton Road, Malvern, Worcestershire, WR14 1BX, United Kingdom
+44(0)1684 571700; Fax: +44(0)1684 571701
environmental@tracglobal.com; www.tracglobal.com
Products and Services: Testing

TRW Conekt

Technical Centre, Stratford Road, Solihull, B90 4GW, United Kingdom
+44(0)1216 274242; Fax: +44(0)1216 274243
www.conekt.co.uk
Products and Services: Consultancy and Testing provider

TUV Product Service Ltd.

Octagon House, Concorde Way, Segensworth North, Fareham, Hampshire, PO15 5RL, United Kingdom



Montrose Compliance Services, Inc.
Electromagnetic Compatibility and Product Safety

Mark I. Montrose

Consulting and Design Services Seminars (In-house/Private)
Printed Circuit Board Layout and Design for SI/EMI/EMC
In Situ CE Test Laboratory (ISO 17025 Assessed)
Specializing in ITE and Industrial Products for CE Compliance

www.montrosecompliance.com
2353 Mission Glen Drive and FAX +1 (408) 247-5715
Santa Clara, CA 95051-1214 mmontrose@earthlink.net

Fax: +44(0)1489 558100
www.tuvps.co.uk
Products and Services: Testing

U

Uvox Ltd.

Building 14/Unit 3, Stanmore Industrial Estate, Bridgnorth, Shropshire, WV15 5HR, United Kingdom
+44(0)1746 769369; Fax: +44(0)1746 766001
Robin Shedden, Sales Manager, sales@uvox.co.uk
www.uvox.co.uk
Products and Services: Shielding

V

Vector Fields Ltd. / Cobham Technical Services

24 Bankside, Kidlington, OX5 1JE United Kingdom
+44(0)1865 370151; Fax: +44(0)1865 370277
www.vectorfields.com
Products and Services: Shielding

Visteon Engineering Services Ltd.

Dunton Engineering Centre, Dunton, Essex, SS15 6EE, United Kingdom
+44(0)1245 395000;
Martin Black, mblack7@visteon.com;
www.visteon.com/testing
Products and Services: Testing

W

Wemtech

Bordesley Hall, The Holloway, Alvechurch, Birmingham, B48 7QQ United Kingdom
+44(0)1527 595066; +44(0)1527 595033
www.wemtech.co.uk
Products and Services: Consultancy, Training

Westbay Technology Ltd.

Main St. Baycliff, Ulverston, Cumbria, LA12 9RN United Kingdom
+44(0)1229 869798; Fax: +44(0)1229 869108
www.westbay.ndirect.co.uk
Products and Services: Testing



Würth Electronics UK Ltd.

Exchange Quay, The Office Oxfordshire Village, First Floor, Building 24, Salford, Quays, N5 3CQ, Manchester United Kingdom
+44(0)1618 720431; Fax: +44(0)1618 720433
eiSos-uk@we-online.com
Products and Services: Cables & Connectors, Ferrites

Y

York EMC Services Ltd.

Market Square, University of York, Heslington, York, YO10 5DD, United Kingdom
+44(0)1904 434440
www.yorkemc.co.uk
Products and Services: Signal Generators

Z

Zytronic Displays Ltd.

Whitely Road Blaydon-on-Tyne, Tyne & Wear, NE21 5NJ United Kingdom
+44(0)1914 145511; Fax: +44(0)1914 140545
www.zytronic.co.uk
Products and Services: Filters

ASSOCIATIONS

ELECTROMAGNETIC COMPATIBILITY INDUSTRY ASSOCIATION

Nutwood UK Limited, Eddystone Court, De Lank Lane, St Breward, Bodmin, Cornwall. PL30 4NQ;
+44 (0) 1208 851 530; Fax: +44 (0) 1208 850 871;
emcia@emcia.org; www.emcia.org

INSTITUTION OF ENGINEERING AND TECHNOLOGY

Michael Faraday House, Six Hills Way, Stevenage, Herts, SG1 2AY, UK; +44 (0)1438 313 311;
Fax: +44 (0)1438 765 526;
postmaster@theiet.org; www.theiet.org

RADIO SOCIETY OF United Kingdom

3 Abbey Court, Fraser Road, Priory Business Park, Bedford MK44 3WH, England;
01234 832700; Fax: 01234 831496;
sales@rsgb.org.uk; www.rsgb.org

UNITED KINGDOM & REPUBLIC OF IRELAND IEEE EMC SOCIETY CHAPTER

CST UK Ltd, Strelley Hall, Main Street, Strelley, Nottingham NG8 6PE, United Kingdom
+44 115-906128; Fax: +44 115-906115
Chairman: Alan Warner; aws-emc@talktalk.net
www.ieee-ukri.org

NOTIFIED BODIES

3C TEST LIMITED

Silverstone Technology Park, Silverstone Circuit, Silverstone Northamptonshire NN12 8GX, United Kingdom; +44 (0)1327 857500;
Fax: +44 (0)1327 857747; sales@3ctest.co.uk;
www.3ctest.co.uk

KIWA BLACKWOOD COMPLIANCE LABORATORIES

Unit 8 Woodfieldside Business Park, Pontllanfraith, Blackwood NP12 2DG, United Kingdom;
+44 (0) 1495 229219; Fax: +44 (0) 1495 228331;
blackwoodenquiries@kiwa.co.uk;
www.kiwa.co.uk

CCQS UK LTD

Level 7, CEC Westgate, Westgate House, Westgate Road, London W5 1YY, United Kingdom;
+44 (0)20 8991 3488; info@ccqs.co.uk;
www.ccqs.co.uk

CEM INTERNATIONAL LTD

The Atrium Business Centre Curtis Road, Dorking Surrey RH4 1XA, United Kingdom; +44 (0) 1306 646388; Fax: +44 (0) 1306 646389; info@cem-international.co.uk;
www.cem-international.co.uk

• Over 1,000 technical articles (spanning three decades) covering numerous EMC topics

• In-depth, practical, relevant information written by experts in the field

SUBSCRIBE TODAY
interferencetechnology.com

CONFORMANCE SERVICES LTD

Conformance House, 24 Tidnock Ave., Congleton, Cheshire CW12 2HW, United Kingdom; +44 (0)1260 270729; Fax: +44 (0)1260 270729; enquiries@conformance-services.com; www.conformance-services.com

ERICSSON LIMITED

Unit 4, Middleton Gate, Guildford Business Park, Guildford, GU2 8SD United Kingdom; +44 (0) 1483 30 36 66; Fax: +44 (0) 1483 30 35 37; kirit.surelia@ericsson.com; www.ericsson.com

HURSLEY EMC SERVICES LTD

Unit 16 Brickfield Trading Est., Brickfield Lane, Chandler's Ford, Eastleigh, Hampshire SO53 4DP, United Kingdom; +44 (0)23 8027 1111; Fax: +44 (0)23 8027 1144; sales@hursley-emc.co.uk; www.hursley-emc.co.uk

INTERTEK TESTING & CERTIFICATION

Intertek House, Cleeve Road, Leatherhead, Surrey KT22 7SB, United Kingdom; +44 (0) 1372 370900; Fax: +44 (0) 1372 370999; talban.sohi@intertek.com; www.intertek.com

LLOYD'S REGISTER GROUP LTD

71 Fenchurch St., London EC3M 4BS, United Kingdom; +44 (0)20 7709 9166; Fax: +44 (0) 20 7488 4796; london.client-management@lr.org; www.lr.org

MIRA LIMITED

Watling Street, Nuneaton Warwickshire CV10 0TU, United Kingdom; +44 (0) 24 7635 5000; enquiries@mira.co.uk; www.mira.co.uk

RFI GLOBAL SERVICES LTD

Pavilion A, Ashwood Park, Ashwood Way, Basingstoke RG23 8BG, United Kingdom; +44 (0) 1256 312000; Fax: +44 (0) 1256 312001; info@rfi-global.com; www.rfi-global.com

SAFENET LIMITED

Denford Garage, Denford, Kettering, Northants NN14 4EQ, United Kingdom; +44 (0) 1832 732 174; sales@safenet.co.uk; www.safenet.co.uk

SAI GLOBAL ASSURANCE SERVICES

Winterhill House Snowdon Drive, Milton Keynes, Buckinghamshire, MK6 1AX, United Kingdom; +44 (0) 1926854111; Fax: +44 (0) 1926854222; info.emea@saiglobal.com; www.saiglobal.com

SAMSUNG ELECTRONICS EURO QA LAB

Blackbushe Business Park Saxony Way, Yateley Hampshire GU46 6GG, United Kingdom; +44 (0)1252 863 800; Fax: +44 (0)1252 863 805; s.colclough@samsung.com

SGS UNITED KINGDOM LIMITED

Inward Way, Rossmore Business Park, Ellesmere Port, CH65 3 EN, United Kingdom;

+44 (0) 151 350 6666; Fax: +44 (0) 151 350 6600; keith.hutchinson@sgs.com; www.uk.sgs.com

TECHNOLOGY INTERNATIONAL EUROPE LTD

56 Shrivenham Hundred Business Park Shrivenham, Swindon, Wiltshire SN6 8TY, United Kingdom; +44 (0) 1793 783137; Fax: +44 (0) 1793 782310; sales@iti.co.uk; www.iti.co.uk

TRAC GLOBAL LTD

South Orbital Trading Park, Hedon Road, Hull HU9 1NJ, United Kingdom; +44 (0)1482 801801; Fax: +44 (0)1482 801806; emc@tracglobal.com; www.tracglobal.com

TÜV SÜD BABT

Forsyth House, Churchfield Road, Walton-on-Thames Surrey KT12 2TD, United Kingdom; +44 (0) 1932 251200; Fax: +44 (0) 1932 251201; info@babt.com; www.babt.com

TUV PRODUCT SERVICE LTD

Octagon House, Concorde Way, Segensworth North, Fareham, Hampshire PO15 5RL, United Kingdom; +44 (0) 1489 558100; Fax: +44 (0) 1489 558101; info@tuvps.co.uk; www.tuvps.co.uk

YORK EMC SERVICES LTD

Market Square, University of York, Heslington, York YO10 5DD, United Kingdom; +44 (0) 1904 434440; Fax: +44 (0) 1904 324434; enquiry@yorkemc.co.uk; www.yorkemc.co.uk

EMC GLOBAL SOLUTIONS



EMI RECEIVERS & ANALYZERS
RF IMMUNITY SYSTEMS
FIELD PROBES
ANCILLARIES



Narda Safety Test Solutions srl

Via Leonardo da Vinci, 21/23, 20090 Segrate (MI) ITALY
Phone: +39 02 26 998 71 - Fax: +39 02 26 998 700
E-Mail: nardait.support@L-3com.com - Website: www.narda-sts.it

Applying Stealth Technology to EMC Test Chamber Designs

TOM MULLINEAUX

President
Lionheart Southwest, Inc.

INTRODUCTION

TAKE A LOOK at any semi-anechoic chamber and they all seem to share the same basic design, that is a long cuboid with six flat faces, five of which are identically clad in RF absorbing materials. However, when utilized for RF immunity testing, the performance of the chamber is pretty much dictated by the performance of one wall. That wall is the absorber clad wall that faces the antenna. This article argues that well known stealth techniques could be incorporated in the design of this 'hot' wall so that the chamber exhibits superior all round performance.

BACKGROUND

Achieving field uniformity in a 3 meter semi-anechoic chamber has always been troublesome, and made more so with the need to test up to 6GHz. After much experimentation, test-houses discovered the pragmatic solution was to point the antenna into a corner of the chamber. A moment's thought tells you that the key difference compared to firing the RF straight at the flat face of the hot wall is that some or all of the RF wave is diverted (by reflection) away from the calibration plane.

This can be hard to visualize, so to help gain a rudimentary understanding of the chamber dynamics under these corner illumination conditions, we will apply simple ray tracing. For another method see Note 1.

With ray tracing it is assumed an emitted wave can be modeled as a large number of rays. For our purposes a large number would cause visual overcrowding, so for clarity we will use only three cardinal rays: the bore-sight ray, and the two half-power rays that define the antenna beamwidth limits.

Figure 1 (next page) shows the basic idea. The figure shows a plan view of a chamber (not to scale). The antenna (Note 2) is shown illuminating the calibration plane (black dashed line) and the corner of the chamber.

The maximum field strength E_{max} occurs along the boresight ray (green). The field will be at $E_{max} / \sqrt{2}$ along the rays defining the half-power beamwidth (red and orange).

The test frequency is high so only the shorter rods of the antenna are active and the beamwidth is comparatively narrow.

Figure 2 (next page) shows the three resultant reflected rays. It can be seen that the green boresight ray and the red half-power ray pass through the calibration plane once only (the ideal), but unfortunately the orange ray passes through twice. However, this is better than all three re-passing through the plane as is the case with the antenna facing the hot wall. On route, the orange ray passes

MILMEGA

The Difference between ordinary and extraordinary



MILMEGA Launches 600V/m EMC Test solution

Introducing the new AS0104-700/300 dual band solid state amplifier.

The MILMEGA dual band technology enables operation at full saturated power without creating unwanted harmonics within the 1 to 4GHz band.

Designed to exceed the requirements of the automotive radar pulse test standards using existing horns.

MILMEGA has also released the new MILMEGA lensed horn 1 to 4GHz. A single horn solution for 600V/m across both radar bands when used in conjunction with the new MILMEGA AS0104-700/300 amplifier.

- Class Leading Linearity and Noise Specifications
- Harmonics below 20dB even at saturation
- Guaranteed output power levels
- 5 Year all inclusive warranty
- Local technical support

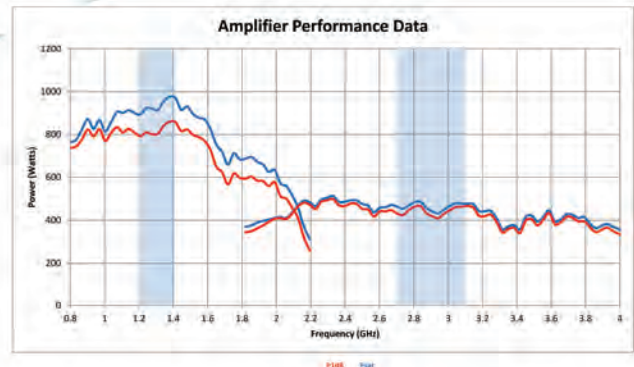

We promise only what we can deliver...
then deliver more than we promise

AMETEK[®]
COMPLIANCE TEST SOLUTIONS

Designers and Manufacturers
of High Power Microwave
and RF Amplifiers



RF/Microwave Amplifiers

MILMEGA Limited Park Road, Ryde, Isle of Wight, PO33 2BE United Kingdom
Tel. +44 (0) 1983 618004 Fax. +44 (0) 1983 811521 sales@milmega.co.uk www.milmega.co.uk

through two attenuation interfaces, which although the ray is not impinging at the intended normal incidence, could result in greater attenuation than a single pass at normal incidence. The intention is to determine the level of attenuation of this non-normal incidence route using 3D EM software, see Note 1.

Given that this pragmatic approach uses deflection to help achieve a uniform field, and that this is a key principle used by stealth aircraft, is it feasible to apply stealth principles to the hot wall?

To examine this prospect, we first need to introduce a key concept used in stealth technology - RADAR Cross Section (RCS).

RADAR CROSS SECTION

A simplistic way of looking at the RADAR Cross Section (RCS) concept is to consider a target comprised of a 1 meter square, fully reflecting sheet, facing the RADAR system antenna. We then fire a RADAR pulse at the sheet resulting in an echo that is detected and processed by the RADAR system. The strength of the echo return from this ideal reflector is now used as the base-line comparator. Echoes from aircraft are then compared to this ideal echo signal strength. Particular aircraft can then be allotted a RCS number (in meters squared). Stealth technology strives to obtain the lowest RCS possible.

Figure 3(a) shows the 1 meter squared sheet from the side (the point of view of the RADAR antenna) and from above. The green arrows represent the incident RF, the red ones the echo heading back to the RADAR antenna.

Figure 3(b) shows the sheet turned at an angle to the source of RF. The RCS plummets due to the deflection of the RF echo away from the antenna. Although about 90% of the sheet area is still visible to our eyes, the sheet is almost invisible to the RADAR system due to the weakness of the echo returned in the direction of the receive antenna. The stealth aircraft implementation is shown in Figure 4(a)

A second key principle used by Stealth to reduce RCS is attenuation of the returned echo through RADAR absorptive coating. This is what the chamber cladding strives for too, of course. The ideal (100% absorption) is shown in Figure 3(c) and the stealth aircraft implementation is shown in Figure 4(b)

APPLYING THESE STEALTH PRINCIPLES TO THE HOT WALL

In terms of this application, applying stealth techniques means the field emanating from the antenna makes a single pass through the calibration plane from a single direction. So the minimized RCS is from the perspective of the calibration plane. That is the new hot wall should be all but invisible to a field probe located anywhere on the calibration plane.

Clearly the new hot wall design will strive to use deflection and attenuation to achieve this.

Figure 5 shows one possible arrangement. The hot wall is comprised of a flat sided fully reflective 3D pyramid with its apex centered on the antenna boresight. For clarity the cladding has been omitted from the hot wall along with the temporary 1 meter wide cladding 'palettes' that are placed on the floor between the calibration plane and the antenna mount (see below).

Taking the three cardinal rays one at a time:

- The top one (red) is nicely deflected
- The bottom one (orange) is deflected down to the floor mounted attenuator palettes, or if it lands to one side of a palette, it is further deflected away from the

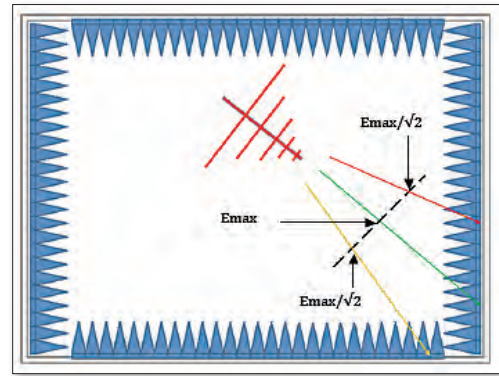

FIGURE 1: Cardinal rays emitted by the antenna

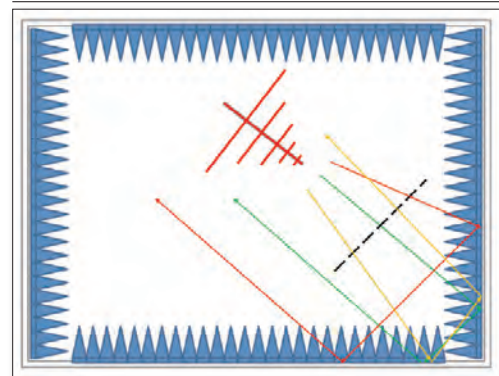

FIGURE 2: Cardinal rays reflecting off the corner walls

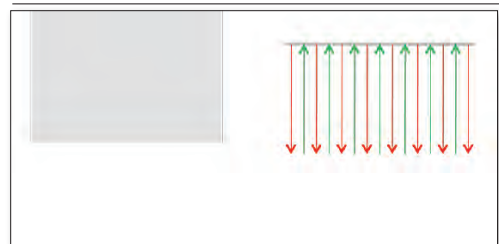

FIGURE 3(a): 1 meter square sheet of fully reflecting material facing source of rays

calibration plane

- The boresight ray is an issue as it will be reflected straight back at the antenna, passing through the calibration plane again as it goes

To put the amount of reflected field from the boresight ray in perspective, it should be remembered that the surface area of the apex point facing the antenna will be tiny, and as shown by a neighboring ray with a small angular offset (Figure 5, brown dashed-line), rays with even a slight offset angle do not revisit the calibration plane.

As regards lower frequency attenuation, the ferrite tiles would have to be cut or formed to the shape of the apex faces, and also to fit along the edges where the pyramid faces meet. This will increase the effective area facing the antenna, but the total area will still be tiny compared to illuminating a flat wall at normal incidence.

CLADDING THE PYRAMID

For the proposed new hot wall design, non-standard- cut/formed pyramidal absorber matrices would be required so they face squarely towards the opposite wall. Also, as previously

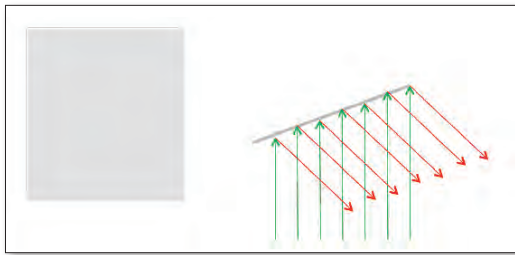

FIGURE 3(b): Same sheet at an angle to source of rays

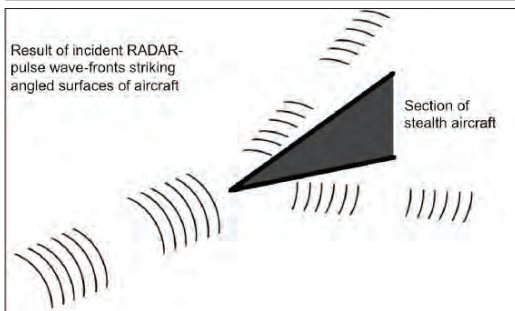

FIGURE 4(a)

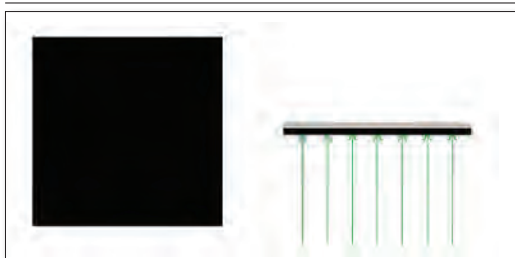

FIGURE 3(c): Same sheet coated in RAM, facing source of rays

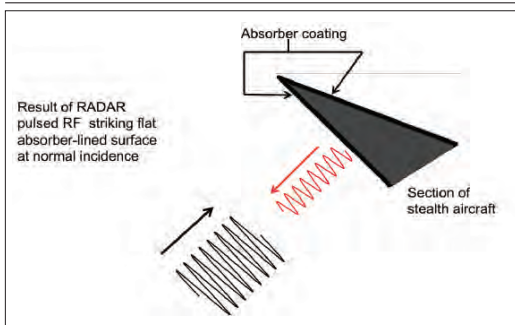

FIGURE 4(b)

mentioned, ferrite tiles may need to be pre-molded to cater for the angled faces and the apex of the new wall.

CLADDING THE FLOOR

This practice is already commonplace due to the difficulty of achieving field uniformity. The palettes are arranged to form a continuous one meter wide line between the antenna and the calibration plane.

A cross section of a typical palette with its castors is shown in Figure 6. These are rolled into place during the test set-up. For repeatability, there should be clamping mechanisms that ensure the palettes are aligned consistently. Figure 7 shows one way to do this, where all the castors sit in their respective recess in the floor and the palette is then lined up and fastened in place (four anchor points per palette).

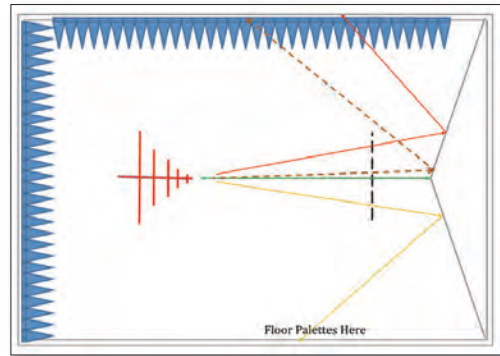

FIGURE 5

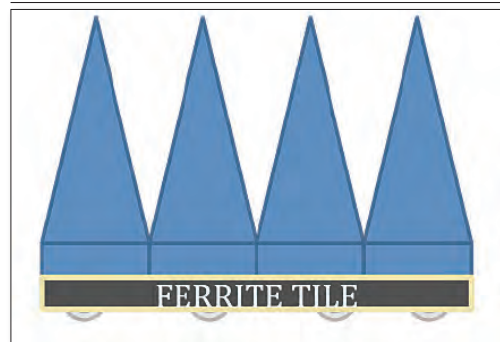

FIGURE 6

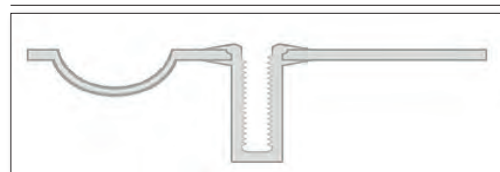

FIGURE 7

CONCLUSION

On the face of it, it should be perfectly feasible to obtain field uniformity with the antenna facing a flat absorber clad wall. Plainly this is not the case as evidenced by the need to point the antenna into a corner. If this pragmatic solution is in fact employing stealth techniques, then why not go the whole hog and employ them intentionally? The key to field uniformity is for the RF wave to make a single pass through the calibration plane from a single direction. Using stealth principles epitomized by stealth aircraft is a giant step towards achieving this. Obstacles to this or a similar solution being adopted include the added complexity (read expense) of manufacture and assembly. However, 3 meter semi-anechoic chambers are artificially high due to the scan height requirement used at OATS (Open Area Test Site) facilities. If it turns out the new hot wall results in a vastly superior quiet zone, maybe one day the additional height will be unnecessary and would be a good trade for the extra length required for the new hot wall.

NOTES

1. The intention is that a 3D EM analysis of a contoured hot face will be published on Interference Technology's website blog page (EMC-Zone.com). Thanks are owed to CST for the kind loan of their CST Studio Suite © 2014
2. For ease of visualization the antenna is shown horizontally polarized. In the 3D EM analysis the antenna will be vertically and horizontally polarized.

Assessing Low Frequency Magnetic Field Exposure in Hybrid and Electric Vehicles

ALASTAIR R. RUDDLE, PH.D.,
LESTER LOW, PH.D.

Consultants
MIRA Limited

ELECTRICAL POWERTRAIN technologies are currently of considerable interest within the automotive industry as a way of mitigating some of the inefficiencies of internal combustion engines (ICEs), or even eliminating ICEs completely, as well as eliminating tail-pipe emissions in urban areas. This would offer many important benefits to society, including lower levels of local pollution and carbon emissions, as well as reduced dependence on fossil fuels. Furthermore, the move to electrical power transfer also allows for greater flexibility and innovation in the physical architecture of the vehicle, such as in-wheel motors that do not need to be mechanically linked to on-board power sources. However, these changes also bring new technical challenges for the designers of vehicle systems. Amongst these, one issue that may not be immediately obvious is the need to ensure that the exposure of occupants and bystanders to electromagnetic fields generated by the vehicle complies with recommended exposure limits.

Currents that change over time give rise to changing magnetic fields that can induce electric fields and current flow in biological tissues, which are weakly conducting. Such currents can result in acute physiological responses. At low frequencies, these effects may lead to undesirable electro-stimulation of muscles and nerves if the rate of change magnetic field is sufficiently high. At higher frequencies (above 100 kHz), heating effects are also a potential source of damage to biological tissues. Thus, electromagnetic field exposure is recognized as a potential health and safety issue that must be controlled, and recommendations for limiting human exposure to electromagnetic fields have therefore been issued by various national and international bodies.

IN-VEHICLE MAGNETIC FIELD EXPOSURE

Vehicles equipped with electrical powertrains require significant electrical power (of the order of 5–200 kW, depending on the vehicle type [1]) to be routed around the vehicle between the on-board power sources (stored or generated) and the electrical machines. Given the size and space constraints of vehicles, the occupants are likely to be in relatively close proximity to electrical powertrain components, including high power electrical machines, inverters and other power electronics systems,

RADIATED IMMUNITY TESTING MORE FIELD, LESS POWER (LESS MONEY TOO)

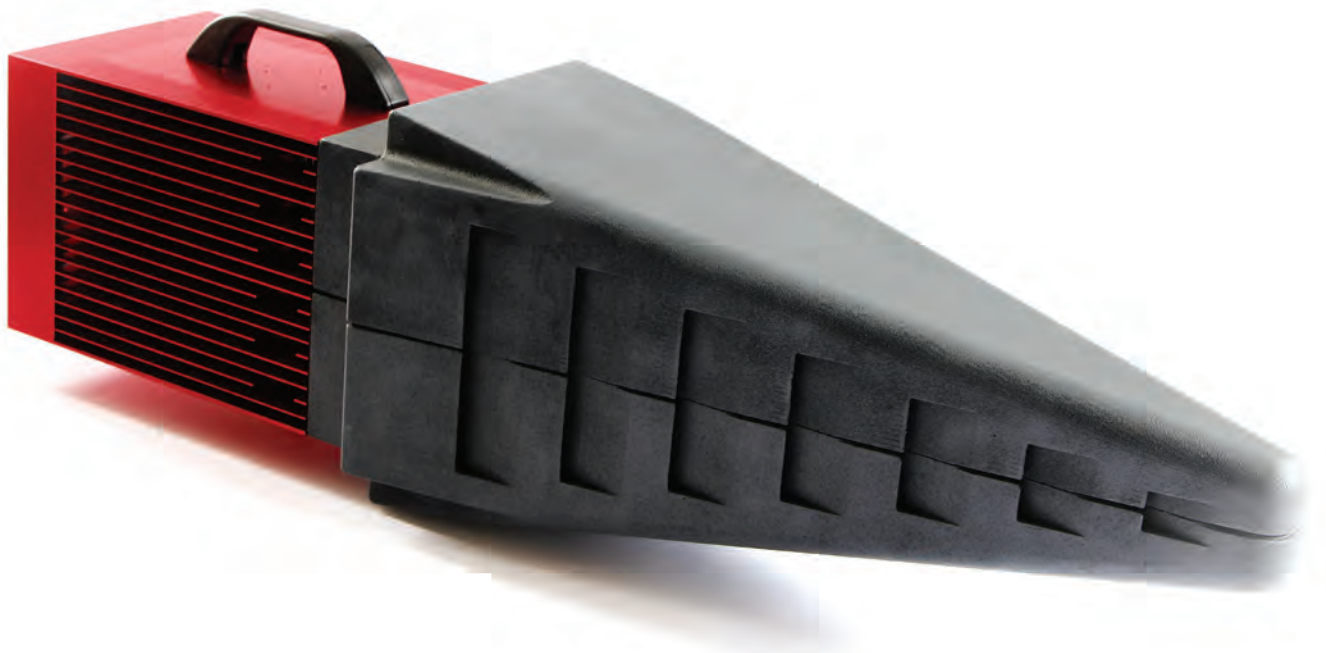

Some things in life seem unavoidable. For an EMC engineer conducting IEC 61000-4-3 tests, its suffering with the complexity of RF immunity systems, buying bigger amps to compensate for reflected power loss from the load, and spending more money.

We're changing all that with the new EMfield™ Generator. It's everything you need to generate a 3 or 10 V/m at 3 m over 1 to 6 GHz in a sleek,

compact, configuration. Remarkably power efficient with minimal signal loss, it comes without the bulk, complexity, or cost of typical immunity systems. It's a new revolution that's creating a smarter and less expensive way to do radiated immunity (RI) testing.

If you're ready to simplify your radiated immunity testing and save money too, get more information at www.emfieldgenerator.com.

 **ETS-LINDGREN**[®]
An ESCO Technologies Company

Offices Worldwide | ets-lindgren.com

10/14 KTD ©2014 ETS-Lindgren

as well as high voltage power cables. Thus, increasing deployment of electrical powertrains for vehicles, as well as related technologies such as wireless charging of traction batteries, is making the assessment of magnetic field exposure in vehicles increasingly important.

An extensive study of electromagnetic field exposure in the band 5 Hz to 3 kHz for a wide variety of transport systems [2], which included cars and trains, found no evidence for measurable electric fields. Nonetheless, this and more recent investigations have shown that low-frequency magnetic fields are routinely encountered in electrified transport systems.

In [3] it is reported the highest magnetic fields tend to be found where the body is close to high power cables (often near the feet of the driver or front passenger) or traction batteries (e.g. around the lower back for rear passengers in vehicles with batteries located in the rear). Traction batteries are also mounted below the occupants in some vehicle architectures, whereas the electric motor is generally located at the front axle. Thus, high voltage power cables often pass below the occupants, carrying current waveforms that may reach peaks of the order to 10^2 – 10^3 A over very short periods of time, with the current even reversing direction during the transition to regenerative braking. The high voltage power cables may carry current in single-phase or three-phase form, depending on the relative positions of the electrical machines, inverters and electrical energy storage device (most commonly a high voltage traction battery). Measurements of the traction current and the magnetic field in the vicinity of the driver's feet in a small electric car were found to be strongly correlated [4].

A further feature of hybrid and electric vehicles that may be significant for magnetic field exposure is that lightweight materials are increasingly widely used in order to reduce mass and so enhance the fuel efficiency of hybrids and ICE vehicles, or to maximize the range of electric vehicles. These materials include metals with low magnetic permeability (e.g. aluminium), poor conductors (e.g. carbon-fibre) or even non-conductors (e.g. glass-fibre or plastics). Simulations indicate that the shielding of low frequency magnetic fields is poor even with traditional steel body panels, which are typically less than 1 mm thick, but lightweight materials are even poorer still in this respect [5].

It should be noted, however, that low frequency magnetic field sources are also present in conventional vehicles. Combustion engine cranking also draws currents that rise to levels of the order of 10^2 – 10^3 A in only a few milliseconds, and whereas this used to be a once-per-journey phenomenon, these cranking events now occur far more frequently in modern cars with stop-start capabilities. Other sources include other on-board electrical equipment, and even magnetized material such as the steel in the wheels and tyres, which generate low frequency magnetic fields while rotating [6].

Magnetic field exposure in vehicles is not routinely assessed at present, as there are no field exposure standards relating specifically to the in-vehicle environment. Although standards for assessing specific human exposure threats have been developed for a number of applications (including for electric traction in the railway environment [7]), work on an automotive standard (IEC 62764-1 [8]) was not initiated until 2013. Although it is intended that IEC 62764-1 will apply to all vehicle types, it seems likely the increasing deployment of electrical powertrain technology has probably been the primary motivation for initiating the development of this standard.

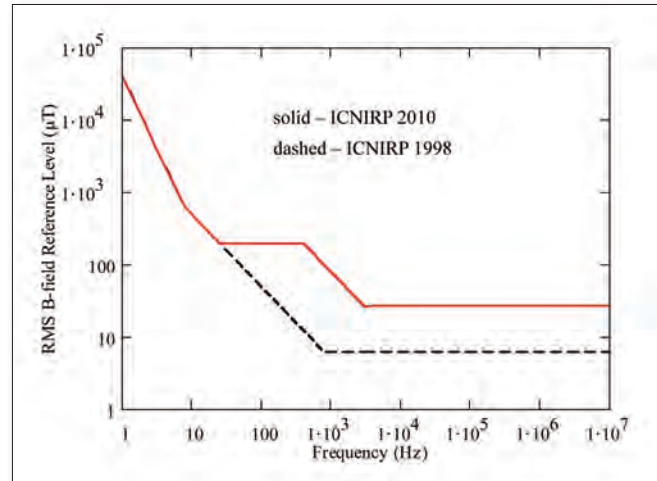

FIGURE 1: Magnetic flux density reference levels for electro-stimulation effects from ICNIRP 1998 [9] and ICNIRP 2010 [13] for general public exposure.

MAGNETIC FIELD EXPOSURE RECOMMENDATIONS

Generic recommendations for limiting human exposure to electromagnetic fields were published by the International Commission for Non-Ionizing Radiation Protection (ICNIRP) in 1998 [9]. The latter recommends limits for occupational exposure as well as for the general public exposure. Higher levels are permitted for occupational exposure than for the general public since it is assumed that workers will be drawn from a more restricted sub-set of the population (in terms of age and health), and will be routinely monitored if operating in a high-field environment. The general public, however, may be of any age and health and will not be routinely monitored for health issues relating to field exposure, or even aware that they may have been exposed. The ICNIRP 1998 recommendations for general public exposure [9] were subsequently reflected in an EU recommendation (1999/519/EC [10]).

The field exposure limits are actually specified in terms of in-body quantities, often described as “basic restrictions”. As such parameters are not easy to determine experimentally, more readily measurable “field reference levels” have been derived from the basic restrictions. The field reference levels vary with frequency and are defined for purely sinusoidal sources. It is assumed that if the electromagnetic environment complies with the field reference levels, then compliance with the exposure limits is guaranteed. Nonetheless, exceeding the field reference levels does not necessarily mean that the basic restrictions are also breached, although it is considered that at these field levels more detailed investigation is required in order to establish this.

For assessment against EMC emissions requirements, an equipment is considered to be compliant as long as the emission limits are respected at each frequency. However, the situation is very different when assessing human exposure, where possible additive effects of exposures at multiple frequencies are required to be taken into account. Thus, the more frequencies that are present, the lower the levels that can be tolerated for any of them relative to the field reference levels. Furthermore, the influence of other fields that may be present in the environment also impact on what can be tolerated from equipment generating fields that people may be exposed to.

From [9]–[10], it is recommended that the low frequency

magnetic field environment that humans are exposed to should satisfy the following criterion:

$$\sum_{f_i = 1 \text{ Hz}}^{150 \text{ kHz}} \frac{B_{RMS}(f_i)}{B_{RL}(f_i)} + \sum_{f_i \geq 150 \text{ Hz}}^{10 \text{ MHz}} \frac{B_{RMS}(f_i)}{c} \leq 1 \quad (1)$$

where the terms $B_{RMS}(f_i)$ represent the net RMS magnetic flux densities at each of the frequencies f_i that are present, the $B_{RL}(f_i)$ represent the corresponding field reference levels, and the constant c is 6.25 (for fields in μT). A similar approach is also described in the IEEE standards relating to human exposure [10]–[12], although in these documents the frequency range for the evaluation of electro-stimulation threats is up to 5 MHz. For vehicle electrical powertrain applications this difference in the maximum frequency of the summation makes little practical difference as the associated magnetic fields are found to be dominated by frequencies below 3 kHz ([2]–[4]).

In 2010 ICNIRP published revised recommendations [13] that relate specifically to electro-stimulation effects. The magnetic flux density reference levels are compared in Fig. 1, which shows that that the new levels are higher above 25 Hz.

The criterion indicated in (1) is a valid approach for truly independent sources, which could potentially add in phase. However, this method may be excessively conservative for non-sinusoidal sources that produce broadband exposures, such as vehicle traction current waveforms.

NON-SINUSOIDAL EXPOSURES

An alternative approach for non-sinusoidal exposures was proposed in [14], which takes account of the relative phases of the frequency components as well as their magnitudes. Consequently, for a magnetic flux density $B(t_u, \mathbf{r}_j)$ at point \mathbf{r}_j and time t_u the net exposure at each point in space and time, expressed as a percentage of the field reference levels, is given [4] by:

$$EMB(t_u, \mathbf{r}) = 100 \sqrt{\sum_{k=1}^3 [emB_k(t_u, \mathbf{r}_j)^2]} \quad (2)$$

where the terms $emB_k(t_u, \mathbf{r}_j)$ represent time-varying exposure measures determined for each of the Cartesian components k (where $k \in \{1, 2, 3\}$) of $\mathbf{B}(t_u, \mathbf{r}_j)$, which are evaluated using the inverse Fourier transform approach indicated in [13]–[14]:

$$emB_k(t_u, \mathbf{r}) = \left| \sum_{n=N}^P \frac{|B_{jkn}|}{\sqrt{2}B_L(n\Delta)} \cos \{2\pi n\Delta t_u + \arg(B_{jkn}) + \phi_B(n\Delta)\} \right| \quad (3)$$

In equation (3) the terms B_{jkn} represent the n^{th} of $M/2$ complex Fourier components obtained from $M+1$ time samples of the magnetic flux density waveform $\mathbf{B}_j(t_u, \mathbf{r}_j)$ for Cartesian component k at point \mathbf{r}_j and time t_u (for $0 \leq u \leq M+1$), and Δ is the corresponding frequency increment, where $N\Delta \geq 1$ and $P\Delta \leq 10^7$ such that the summation is limited to frequencies ranging from 1 Hz to 10 MHz ([9], [10], [13]). Considering the frequency response of the basic restrictions as a filter function, the parameters $\phi_B(n\Delta)$ are the phase angles of the filter, which vary according to the frequency dependence of the reference level in particular frequency bands. The filter phase angles are specified as $\pi, \pi/2, 0$ and $-\pi/2$ radians where the frequency dependence of the reference level varies as f^{-2}, f^{-1}, f^0 and f , respectively [13]. The field reference level $B_L(n\Delta)$ for magnetic flux density is specified as an RMS value in [9]–[13], and is therefore multiplied by $\sqrt{2}$ in (3) in order to derive the corresponding peak value for

comparison with the magnitudes of the spectral components ($|B_{jkn}|$). The terms $B_L(n\Delta)$ may represent either the general public or occupational exposure reference levels, as required.

For measurement purposes, ICNIRP also suggest ([13]–[14]) that his type of assessment could also be implemented by processing the magnetic field waveforms in the time domain, using filters that approximate the inverse of the frequency response of the field reference levels, provided that the attenuation and phase characteristics do not deviate by more than 3 dB and 90°, respectively, from the exact piecewise linear frequency response of the field reference levels [13]. This approach has also been applied to derive exposure measures from simulated magnetic field waveforms, using a circuit simulator to emulate the required filter response [15].

ASSESSING IN-VEHICLE MAGNETIC FIELD EXPOSURES

The field reference levels have been derived from the basic restrictions using models that represent a standing human exposed to a uniform field distribution in an open environment. This is very different to the in-vehicle environment, where the occupants are seated, possibly in relatively close proximity to the field sources, and surrounded by vehicle structures. However, it is noted in [9] that the field reference levels “are intended to be spatially averaged values over the entire body of the exposed individual, but with the important proviso that the basic restrictions on localized exposure are not exceeded”. Similar comments are also found in [10], although neither [9] nor [10] provide any suggestions concerning acceptable levels of non-uniformity. Thus, the use of spatially averaged field values to describe non-uniform, non-localized exposures is anticipated in the exposure guidelines, but ICNIRP consider [13] that standardization bodies should give further guidance on the specific exposure situations where the use of spatial averaging may be appropriate, and also derive specific reference levels for particular types of non-uniform exposure.

The magnetic field exposures resulting from traction current transients measured in a small electric vehicle [16] were found [4] to be both time-varying (with temporal gradients of $>100 \mu\text{T/s}$) and spatially non-uniform (with spatial gradients of $>100 \mu\text{T/m}$). As electro-stimulation is an instantaneous phenomenon it is considered that there is no scientific justification to modify the basic restrictions for exposures of short duration [9]. Thus, assessment of these effects must consider the worst-case values, rather than a time average (such as the six-minute average that is specified in [9] for the assessment of tissue heating risks at higher frequencies).

In practical magnetic field surveys, each measurement is effectively a local average that depends on the geometry of the sensing element. Furthermore, the physical size of the sensing element is likely to limit access in complex environments such as the passenger compartment of a vehicle. These practical constraints may make it difficult to ensure that the highest field value that the occupants are exposed to can be found from measurements. Thus, some caution is perhaps advisable in the evaluation of such in-vehicle measurements.

Taking the maximum value of the available magnetic field data over the volume of the body will give a conservative assessment of the exposure threat. The maximum value of the exposure measure indicated in (2), over the occupant region at any point in time, should therefore not exceed 100%:

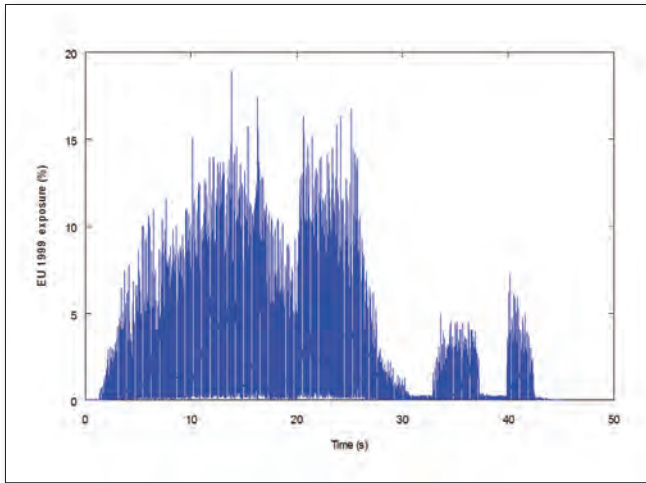

FIGURE 2: Time-varying exposure measure derived from measured magnetic field based on EU recommendation 1999/519/EC [10] and ICNIRP 1998 reference levels for general public exposure [9].

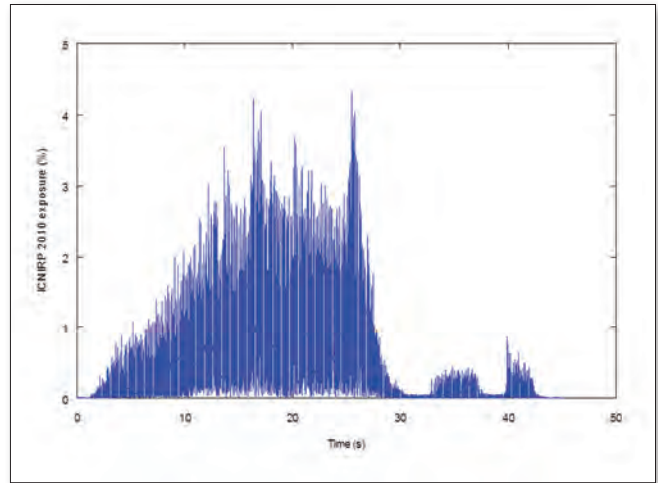

FIGURE 3: Time-varying exposure measure derived from measured magnetic field based on ICNIRP 2010 reference levels for general public exposure [13].

$$\max_{(t_u, \mathbf{r}_j)} \{ EMB(t_u, \mathbf{r}_j) \} \leq 100 \quad (4)$$

Sample results obtained using (2)–(3) are shown in Fig. 2 (relative to the ICNIRP 1998 reference levels) and Fig. 3 (relative to the ICNIRP 2010 reference levels). These results were derived from magnetic field data recorded in the vicinity of the driver’s feet during a simple drive cycle of 45 s duration, which included periods of acceleration and braking.

These results indicate that the worst-case instantaneous exposure is less than 20% of the EU [10] and ICNIRP 1998 general public reference levels [9], and less than 5% of the ICNIRP 2010 reference levels for general public exposure [13]. However, this data relates to a vehicle with only 10 kW motors. The slightly different shapes of these two plots reflect the differences in the reference levels (see Fig. 1).

SIMULATION OF POSSIBLE IMPACT ON OCCUPANTS

The basic restrictions relating to electro-stimulation effects are specified in terms of the current density induced in human tissues in ICNIRP 1998 [9] and 1999/519/EC [10]. However, in the updated ICNIRP 2010 guidelines, which relate specifically to electro-stimulation [13], the basic restrictions are specified in terms of the internal electric field induced in human tissues.

Time-varying exposure measures relating to the basic restrictions can be derived in similar manner to (2)–(3), by replacing the magnetic field term by the in-body quantity and the magnetic field reference levels by the appropriate basic restriction. These parameters should then satisfy the criterion:

$$\max_{(t_u, \mathbf{r}_j)} \left\{ 100 \sqrt{\sum_{k=1}^3 [emB_k(t_u, \mathbf{r}_j)]^2} \right\} \leq 1 \quad (5)$$

where the terms $emQ_k(t_u, \mathbf{r}_j)$ represent time-varying exposure measures determined for each of the Cartesian components k (where $k \in \{1, 2, 3\}$) of the in-body quantity $Q(t_u, \mathbf{r}_j)$, which are evaluated as:

$$emQ_k(t_u, \mathbf{r}_j) = \left| \sum_{n=N}^P \frac{|Q_{jkn}|}{\sqrt{2}R_Q(n\Delta)} \cos \{ 2\pi n\Delta t_u + \arg(Q_{jkn}) + \phi_Q(n\Delta) \} \right| \quad (6)$$

In (6) the terms Q_{jkn} represent the n^{th} of $M/2$ complex Fourier components obtained from $M+1$ time samples of the in-body quantity $Q_{jk}(t_u, \mathbf{r}_j)$ for Cartesian component k at point \mathbf{r}_j and time t_u (for $0 \leq u \leq M+1$), and the parameters $\phi_Q(n\Delta)$ are the phase angles relating to the frequency dependence of the basic restrictions. The basic restriction terms $R_Q(n\Delta)$ may represent either general public or occupational exposures as required.

The simulations were based on a posable and anatomically detailed model of an adult male (“Duke”, from the “Virtual Family” [16]), which includes almost 100 different tissue types. This standing human model was adapted to represent the driver of a small electric vehicle (see Fig. 4).

The reliability of electrical conductivity data for human tissues is considered to be poorer for low frequencies than for frequencies above 1 MHz [18]. The electrical properties used in these models were as supplied by SEMCAD [19]. The internal electric field and current density induced in the tissues were computed (from 1 Hz to 2.5 kHz) using the SEMCAD X ELF quasi-static field solver [20]. As the latter is not able to include metallic structures in magnetic field simulations, only the traction current paths are represented in the models. This is representative of vehicles with non-conducting body panels. For vehicles with steel body panels, however, the in-vehicle exposure is expected to be smaller than this [5].

Two source configurations representing typical magnetic field exposure scenarios due to traction current paths in hybrid and electric vehicles were investigated in [21]. The first configuration was a simple single-phase high-voltage cable passing under the driver. This scenario is found in a number of hybrid and electric vehicles with traction batteries mounted in the rear of the vehicle and a motor and inverter collocated at the front. A single-phase high-voltage power cable then passes beneath the passenger compartment. In the first test case, therefore, a straight horizontal pair of cables carrying oppositely directed currents of equal magnitude is assumed to pass below the axis of the seated human model. The currents were placed at a distance of 5 cm below the lowest point of the body (the heels). The current paths are assumed to be closely-spaced (14 mm apart, as representative of automotive high-voltage cable diameters) to minimize their magnetic field, although larger conductor



FIGURE 4: Figure 1. Driver model derived from the “Duke” human model.

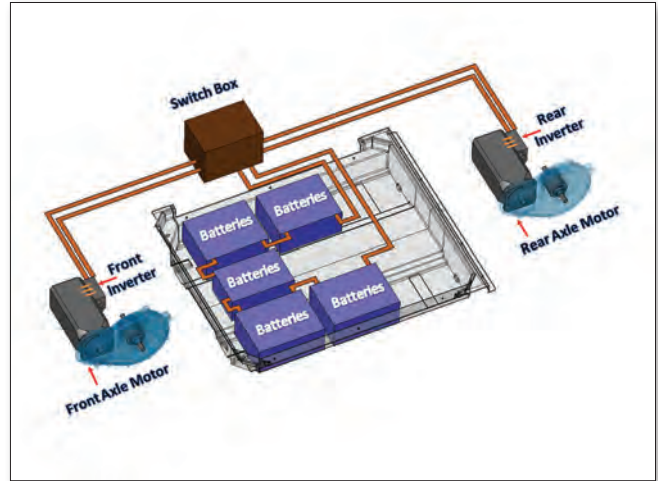

FIGURE 5: Schematic for PMOB vehicle high-voltage power network.

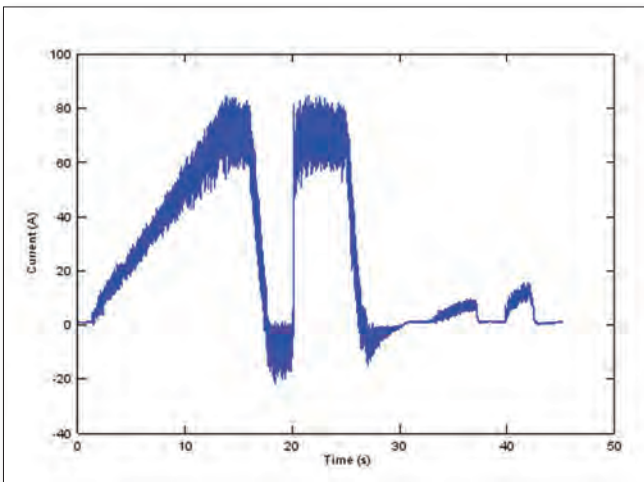

FIGURE 6: Inverter current waveform measured in PMOB electric vehicle.

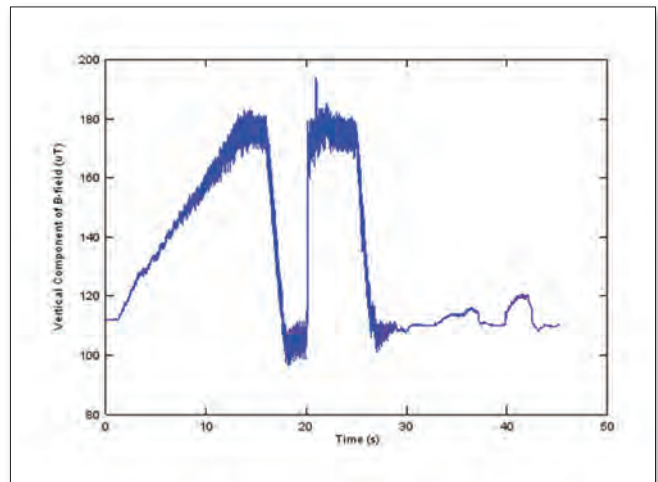

FIGURE 7: Magnetic field waveform measured in PMOB electric vehicle.

separations can be found in vehicles.

The second configuration was a more complex high-voltage power network, representing a traction battery as well as two single-phase cables linking the battery to inverters at the front and rear axles (based on initial designs for a small electric vehicle developed in the FP7 European project PMOB [16]). The traction battery was configured from a number of modules that were initially arranged in a U-shape and linked together in serial fashion, thus forming a large current loop located below the driver’s seat (see Fig. 5). The electrical energy was also distributed in single-phase form to inverters and motors mounted on the front and rear axles. This created three major traction current loops in the vehicle. For the purposes of the simulations the battery current was assumed to be equal to the sum of the two inverter currents. The latter were also assumed to be identical in magnitude but oppositely directed, such that the magnetic field from one of the inverter loops was oppositely directed to the fields of the battery loop and the second inverter loop.

In real-world driving the speed and load demands are constantly varying, resulting in complex time-varying magnetic field exposures. Consequently, a current waveform measured during a short driving cycle in a small (10 kW) electric vehicle was used in order to estimate the magnetic field exposure under realistic driving conditions (including acceleration and deceleration) for both of the test cases. The current waveform

is shown in Fig. 6, while Fig. 7 shows the vertical component of the in-vehicle magnetic field, which was measured concurrently.

The magnetic field amplitude distributions resulting from the source test cases over the region occupied by the driver model are illustrated in Figs. 8–9, for the two source test cases. Results were also obtained for a flat three-phase cable configuration, with the same conductor spacing as the single phase case. This arrangement is also of practical importance as such cables are found in hybrid and electric vehicles that have an inverter collocated with the battery at the rear, while the motor is mounted at the front. However, the three-phase results were almost identical to those reported here for the single-phase case.

The field exposures are highly non-uniform, with maximum values reaching around four times the average values. For the purposes of this investigation, therefore, the maximum values of both the induced electric field and the current density were collected from the human model (for frequencies up to 3 kHz) for both of the source configurations using an arbitrary excitation level (1 A). These were all found to occur in the location of the lower part of the trunk of the seated human model.

COMPARISON OF BASIC RESTRICTION RESULTS

The results obtained from time-domain evaluations of the magnetic flux density and of the induced current density and internal electric field in the driver model are summarized in Table 1 for the two source configurations. This details the maximum

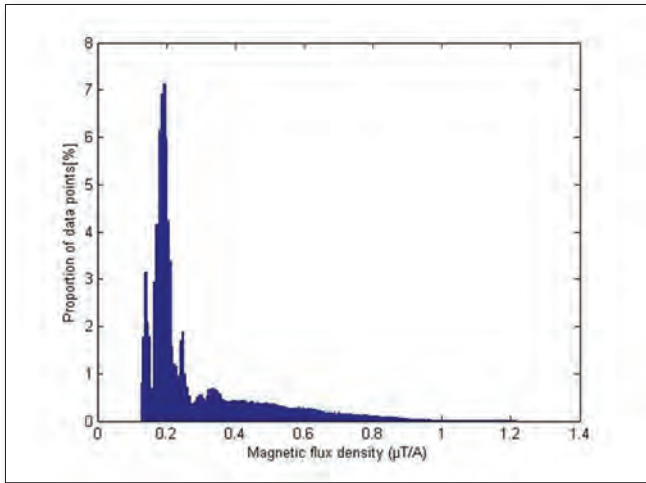

FIGURE 8: Amplitude distribution for net magnetic flux density values over region occupied by human for single-phase high-voltage cable below feet.

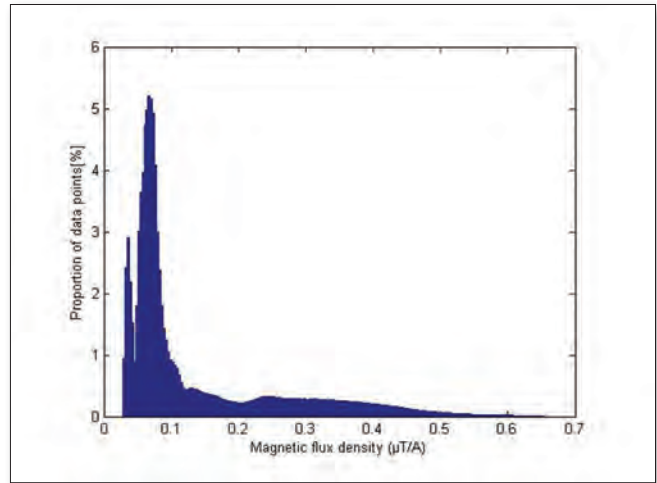

FIGURE 9: Amplitude distribution for net magnetic flux density values over region occupied by human for PMOB vehicle high-voltage power network.

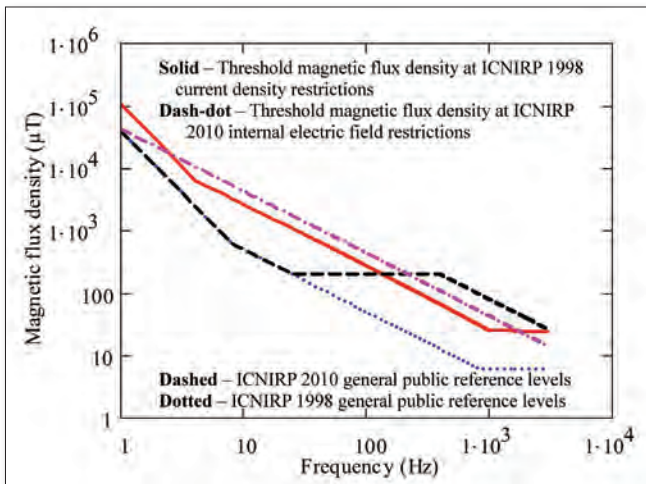

FIGURE 10: Magnetic flux density levels required to reach general public basic restrictions for single-phase cable source compared with field reference levels.

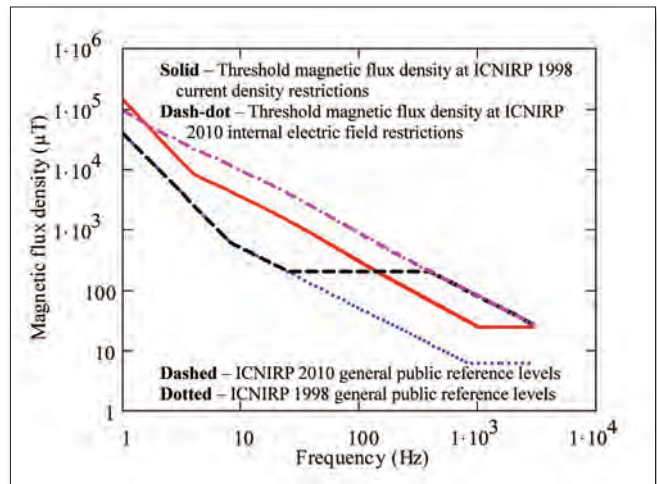

FIGURE 11: Magnetic flux density levels required to reach general public basic restrictions for battery loop source compared with field reference levels.

values of the corresponding time-varying exposure measures derived from the measured current waveform, expressed as a percentage of the field reference levels or basic restrictions as appropriate. It also includes projected values for the basic restrictions that would be expected if the field reference level measures were to reach 100%.

For both source test cases the time-varying exposure measures obtained for the basic restrictions using the measured traction current waveform were below 100% for both of the ICNIRP limits. For the single cable source, the exposure reached only 62% of the ICNIRP 1998 basic restrictions, and indicates that the ICNIRP 1998 field reference levels provide a safety factor as the basic restrictions were estimated to be around 17.5% for exposures that reach 100% of the field reference levels. However, the data based on the ICNIRP 2010 limits reach a smaller proportion of the field reference levels (24.4%) than of the basic restrictions (26.45%), based on the measured current waveform. For exposure at 100% of the reference levels, the projected basic restriction value would reach 108.35%, indicating that the more relaxed field reference levels of ICNIRP 2010 may not provide reliable protection for the basic restrictions for in-vehicle exposure scenarios.

For the battery and cable source configuration, the maximum exposures relative to the field reference levels were higher than the basic restrictions for both ICNIRP 1998 and ICNIRP 2010 (see Table 1). For this test case, therefore, both sets of field reference levels achieved their goal of ensuring that the corresponding basic restrictions were not breached.

Possible concerns about the effectiveness of the ICNIRP 2010 field reference levels have also been reported in relation to some standing models under uniform magnetic field exposures [22]. The models described above have also been used to investigate the relationship between the basic restrictions and the field reference levels for frequencies up to 2.5 kHz [23]. This provides an indication of the safety margins that the reference levels provide for single frequency sources.

The threshold magnetic field levels at which the basic restrictions of ICNIRP 1998 and ICNIRP 2010 would be reached for the single-phase cable source are shown in Fig. 10, which also shows the field reference levels. For this source the ICNIRP 1998 reference levels are lower than the threshold magnetic flux densities for both induced current density (the ICNIRP 1998 basic restriction parameter) and internal electric field (the ICNIRP 2010 basic restriction parameter). Above about 400 Hz,

the threshold fields for the ICNIRP 2010 basic restrictions are only slightly higher than the field reference levels.

For the battery source configuration, the ICNIRP 1998 reference levels are again lower than the threshold magnetic fields for both current density and internal electric field (see Fig. 11). However, the ICNIRP 2010 reference levels are higher than the field thresholds for internal electric field above about 220 Hz.

OTHER CONSIDERATIONS RELATING TO EXPOSURE LEVELS

It should be noted that the ICNIRP recommendations only aim to provide protection against well-established acute physiological effects such as electro-stimulation and tissue heating (the latter for frequencies above 100 kHz). The ICNIRP view regarding chronic effects [13] is that, that while there is consistent epidemiological evidence for an association between childhood leukaemia and power frequency magnetic field exposure (at levels of around 0.3–0.4 μT), a satisfactory causal relationship has yet to be reliably demonstrated. Consequently, ICNIRP regard the evidence for this, and for other possible chronic effects that have been reported, to be too weak to provide a reliable basis for setting field exposure guidelines. Nonetheless, some governments have chosen to set limits for electromagnetic exposure that are intended to provide protection against possible chronic effects, and these are at significantly lower levels than the ICNIRP 1998 general public recommendations.

The World Health Organization (WHO) also consider that the evidence for chronic effects is currently weak and that the health benefits of reducing low frequency magnetic field exposure remain unclear [24]. However, the WHO also recommend the adoption of a precautionary approach, including the consideration of low frequency magnetic field exposure in system design, and possible implementation of field mitigation measures where this can be achieved at low cost and without compromising system performance.

In addition, the EMC requirements for artificial implantable medical devices ([25]–[28]) include immunity requirements that are in part based on the ICNIRP 1998 field reference levels, since the general public were not expected to be exposed to field levels that exceeded the ICNIRP 1998 recommendations. However, this means that the immunity performance of such devices is essentially unknown in field environments that comply with the ICNIRP 2010 recommendations for general public exposure, but exceed the ICNIRP 1998 field reference levels.

CONCLUSIONS

Time-varying low frequency magnetic fields with significant spatial variability are generated in vehicles with electrical powertrains due to high rates of change of traction current on the high voltage power network during driving. Engine cranking operations also produce similar effects in vehicles equipped with combustion engines, and these events now occur routinely during driving for modern cars with stop-start capabilities. Thus, there is a need to consider possible occupant field exposure issues in vehicle design, and to take measures to

TABLE 1: SUMMARY OF TIME-DOMAIN EXPOSURE ASSESSMENTS RELATIVE TO BASIC RESTRICTIONS AND MAGNETIC FIELD REFERENCE LEVELS FOR GENERAL PUBLIC EXPOSURE.

Source test case	Limits applied	Parameter evaluated	Peak exposure (%)	Basic restriction at reference level (%)
Single phase cable path	ICNIRP 1998	Basic restriction	62.44	17.55
		Reference level	355.8	
	ICNIRP 2010	Basic restriction	26.45	108.35
		Reference level	24.41	
Battery and cable current paths	ICNIRP 1998	Basic restriction	32.7	22.35
		Reference level	146.3	
	ICNIRP 2010	Basic restriction	6.64	37.89
		Reference level	17.52	

reduce in-vehicle field levels if necessary.

Simply comparing the magnetic field at each frequency with the corresponding field reference level is not sufficient to evaluate possible human exposure risks. For broadband exposures, such as those produced by traction current waveforms, there is a need to take account of additive effects when assessing human exposure. Furthermore, the spatial field distribution that the occupants are exposed to, which results from electrical powertrain components in relatively close proximity, is not easy to characterize. Suitable methods for measuring and evaluating in-vehicle magnetic field exposure, as well as bystander exposure, are now being considered in the development of the new standard IEC 62764–1 [8]. However, the selection of appropriate limits to be applied in evaluating in-vehicle low frequency magnetic field exposure remains an open question.

The general public exposure class described by ICNIRP would probably be applicable for most vehicle applications. However, it is not certain that the more recent ICNIRP 2010 recommendations [13] are equally applicable in all exposure scenarios. The results reported here, based on simulations of a seated human under exposures that are representative of traction current magnetic fields in hybrid and electric vehicles, suggest that the ICNIRP 2010 field reference levels may not provide a reliable safety margin for the basic restrictions. However, the ICNIRP 1998 field reference levels [9] provided substantial safety margins in terms of both induced current density and internal electric field. Given the nature of in-vehicle exposures and the difficulties of characterizing in-vehicle magnetic fields, there is a need to be cautious in evaluating the possible threat. Furthermore, the EMC requirements of artificial implantable medical devices are partly based around the ICNIRP 1998 field reference levels. Consequently, evaluating the highest field levels against the ICNIRP 1998 reference levels would perhaps give greater confidence for assessing the risks of acute magnetic field exposure effects.

Nonetheless, there may also be a need to assess in-vehicle magnetic field exposure against requirements that are even lower than ICNIRP 1998, which are intended to protect against possible chronic exposure effects ([29] - [30]). Given the global nature of the automotive industry, vehicles may need to comply with the lowest magnetic field exposure requirements in order to ensure that they can be successfully marketed in all territories.

ACKNOWLEDGEMENT

The research leading to these results has received funding from the European Community's Framework Programme (FP7/2007-2013) under grant agreements n° 265772 (EM-Safety project) and n° 314609 (HEMIS project).

REFERENCES

- [1] J. de Santiago et al., "Electrical motor drivelines in commercial all-electric vehicles: a review", IEEE Transactions of Vehicular Technology, Vol. 61, No. 2, 475–484, February 2012.
- [2] F. M. Dietrich and W. L. Jacobs, "Survey and assessment of electric and magnetic field (EMF) public exposure in the transportation environment", US Department of Transportation, Federal Railroad Administration, Report No. PB99-130908, March 1999.
- [3] G. Schmid, R. Überbacher and P. Göth, "ELF and LF magnetic field exposure in hybrid- and electric cars", Proceedings of Bio-electromagnetics Conference 2009, Davos, Switzerland, June 2009, Paper 9–3.
- [4] A. R. Ruddle, L. Low and A. Vassilev, "Evaluating low frequency magnetic field exposure from traction current transients in electric vehicles", Proceedings of 12th International European Symposium on EMC, Bruges, Belgium, September 2013, pp. 78–83.
- [5] A.R. Ruddle and L. Low, "Impact of bodyshell on low frequency magnetic fields due to electric vehicle power cables", Proceedings of 11th International European Symposium on EMC, Rome, Italy, September 2012.
- [6] S. Milham, J. B. Hatfield, and R. Tell, "Magnetic fields from steel-belted radial tires: implications for epidemiologic studies" Bioelectromagnetics, Vol. 20, No. 7, pp. 440–445, 1999.
- [7] CENELEC, EN 50500:2008, "Measurement procedures of magnetic field levels generated by electronic and electrical apparatus in the railway environment with respect to human exposure", August 2008.
- [8] IEC 62764–1, "Measurement procedures for low frequency magnetic field in the automotive environment with respect to human exposure", currently under development, forecast publication date March 2016 (http://www.iec.ch/dyn/www/f?p=103:23:0:::FSP_ORG_ID:1303).
- [9] ICNIRP, "Guidelines for limiting exposure to time-varying electric, magnetic, and electromagnetic fields (up to 300 GHz)", Health Physics, Vol. 74, No. 4, pp. 494–522, April 1998.
- [10] 1999/519/EC, "Council Recommendation of 12th July 1999 on the limitation of exposure of the general public to electromagnetic fields (0 Hz to 300 GHz)", Official Journal of the European Communities, No. L 199, pp. 59–70, 30th July 1999.
- [11] IEEE Standard C95.6-2002, "IEEE standard for safety levels with respect to human exposure to electromagnetic fields, 0–3 kHz", 23rd October 2002.
- [12] IEEE Standard, C95.1-2005, "IEEE standard for safety levels with respect to human exposure to electromagnetic fields, 3 kHz to 300 GHz", 19th April 2005.
- [13] ICNIRP, "Guidelines for limiting exposure to time-varying electric and magnetic fields (1 Hz to 100 kHz)", Health Physics, Vol. 99, No. 6, pp. 818–836, December 2010.
- [14] ICNIRP, "Guidance on determining compliance of exposure to pulsed and complex non-sinusoidal waveforms below 100 kHz with ICNIRP guidelines", Health Physics, Vol. 84, No. 3, pp. 383–387, March 2003.
- [15] Y. Hamnerius and T. Nilsson, "Assessing complex low frequency magnetic fields against the EU Directive for worker protection", Proceedings of 13th International European Symposium on EMC, Gothenburg, Sweden, September 2014, pp. 364–368.
- [16] P-MOB Project, FP7-ICT-260087 (<http://eeepro.shef.ac.uk/p-mob/>).
- [17] A. Christ et al., "The Virtual Family – development of surface-based anatomical models of two adults and two children for dosimetric simulations", Physics in Medicine and Biology, Vol. 55, No. 2, January 2010, pp. N23–N38.
- [18] C. Gabriel, A. Peyman and E.H. Grant, "Electrical conductivity of tissue at frequencies below 1 MHz", Physics in Medicine and Biology, Vol. 54, No. 16, August 2009, pp. 4863–4878.
- [19] SEMCAD Dielectric Properties Database, Schmid & Partner Engineering AG. (<http://www.itis.ethz.ch/itis-for-health/tissue-properties/database/dielectric-properties/>).
- [20] SEMCAD X ELF, Schmid & Partner Engineering AG. (<http://www.speag.com/products/semcad/solutions/elf/>).
- [21] A.R. Ruddle and L. Low, "Exposures representative of traction current magnetic fields in hybrid and electric vehicles – I: Simulation of basic restrictions in a seated human", Proceedings of 13th International European Symposium on EMC, Gothenburg, Sweden, September 2014, pp. 348–353.
- [22] J.F. Bakker et al., "Children and adults exposed to low-frequency magnetic fields at the ICNIRP reference levels: theoretical assessment of the induced electric fields", Physics in Medicine and Biology, Vol. 57, No. 7, January 2012, pp. 1815–1829.
- [23] A.R. Ruddle and L. Low, "Exposures representative of traction current magnetic fields in hybrid and electric vehicles – II: Safety factors provided by field reference levels", Proceedings of 13th International European Symposium on EMC, Gothenburg, Sweden, September 2014, pp. 354–359.
- [24] World Health Organization, Environmental Health Criteria 238, "Extremely low frequency fields", World Health Organization, Geneva, December 2007, p. 372–373.
- [25] CENELEC, "EN 45502-1:1997, Active implantable medical devices – Part 1: General requirements for safety, marking and information to be provided by the manufacturer", August 1997.
- [26] CENELEC, "EN 45502-2-1:2004, Active implantable medical devices – Part 2-1: Particular requirements for active implantable medical devices intended to treat bradyarrhythmia (cardiac pacemakers)", September 2004.
- [27] CENELEC, "EN 45502-2-2:2008, Active implantable medical devices – Part 2-2: Particular requirements for active implantable medical devices intended to treat tachyarrhythmia (includes implantable defibrillators)", March 2008.
- [28] CENELEC, "EN 45502-2-3:2010, Active implantable medical devices – Part 2-3: Particular requirements for cochlear and auditory brainstem implant systems", February 2010.
- [29] GB 8702-2014, "Controlling Limits for Electromagnetic Environment", Standardization Administration of China.
- [30] SanPin 2.2.4./2.1.8-14, "Sanitary rules and regulations. Hygiene requirements for the physical factors of production and the environment", Russian Federation (in draft).

ABOUT THE AUTHORS

Alastair Ruddle has been with MIRA Ltd (Nuneaton, UK) since 1996, working primarily on the use of numerical modeling methods to investigate electromagnetic issues for automotive applications. Specific areas of interest include EMC, installed performance of antennas, human exposure to electromagnetic fields, and associated test and measurement methods. He can be contacted at alastair.ruddle@mira.co.uk.

Lester Low has been with MIRA Ltd (Nuneaton, UK) since 2010, working mainly on electromagnetic field modeling for automotive applications. Prior to this he was a research associate at the University of Kent (Canterbury, UK) and at the University of Sheffield (Sheffield, UK). He can be contacted at lester.low@mira.co.uk.

Our expertise takes you to the top. EMC solutions from Rohde & Schwarz.

We provide everything you need for development, precompliance and compliance measurements to ensure successful EMC certification.

- | Exceptionally fast EMI test receivers
- | Efficient diagnostic tools for detecting EMI
- | EMC software packages for interactive and fully automatic measurements
- | Wide range of accessories for performing EMI measurements
- | Compact and modular broadband amplifiers
- | RF shielded chambers
- | Complete EMC test systems

For more information, visit:

www.rohde-schwarz.com/ad/emc



ROHDE & SCHWARZ

DEUTSCHLAND



48 **PRODUKTE UND SERVICES**

58 **RESSOURCEN**

60 **ARTIKEL**

Messen Unter Störbeeinflussung

JORG HACKER, Langer EMV-Technik GmbH

Wie Viel ESD Verträgt Ein Ic?

JORG HACKER, Langer EMV-Technik GmbH

Our Support Is As Strong As Our Products



- ✓ Upgrades, Verification, Calibration, Technical Support, Maintenance
- ✓ Four European Service Centres: UK, BENELUX, FRANCE and GERMANY
- ✓ Competent, Well Trained European Service Team
- ✓ First Class and Speedy Support

www.ar-europe.ie

ardeinfo@arworld.us

+49 6101 80270 0

ISO 9001:2008
Certified

ar europe

National Technology Park, Ashling Building, Limerick, Ireland • +353 61 504300 • www.ar-europe.ie

In Europe, call ar United Kingdom +44 1908 282766 • ar France +33147917530 • ar Deutschland +49 6101 80270 0 • ar Benelux +31 172 423000

www.arworld.us

Copyright © 2014 AR. The orange stripe on AR products is Reg. U.S. Pat. & TM. Off.



PRODUKTE UND SERVICES

1-9

7 layers

Borsigstrasse 11, Ratingen 40880, Deutschland
+49(0)2102 7490; Fax: +49(0) 2102 749350
info@7Layers.com; www.7layers.com
Produkte und Services: Antennen, Testausstattung, Testen

A



A.H. Systems, Inc.

Pro Nova Elektronik GmbH, Ludwigsburg, Deutschland;
+49 7141 2858 20; Fax: +49 7141 2858 29
info@pn.com.de; www.AHSystems.com
Produkte und Services: Antennen, Testausstattung, Testen



Aaronia AG

Gewerbegebiet Aaronia AG, Strickscheid,
RLP, 54597, Deutschland
+49(0)6556 93033; Fax: +49(0)6556 93034
Manuel Pinten; mail@aaronia.de
www.aaronia.de
Produkte und Services: Verstärker, Antennen, Kabel und Steckverbinder, Schirmung, Test Instrumentation, Testing, Diverses



Albatross Projects GmbH

Daimlerstraße 17, 89564 Nattheim, Deutschland;
+49(0)7321 730500; Fax: +49(0)7321 730590;
info@albatross-projects.com; Dr. Michael Kueppers;
m.kueppers@albatross-projects.com; Thomas Baisch;
t.baisch@albatross-projects.com
www.albatross-projects.com
Produkte und Services: Abgeschirmte Räume und Gehäuse, Absorberhallen

AMS Technologies AG

Fraunhoferstrasse 22, Martinsried, INTL,
D-82152, Deutschland;
+49(0)11 498 989577561; Fax: +49(0)11 498 989577199;
de_info(at)amstechnologies.com;
www.amstechnologies.com
Produkte und Services: Verstärker, Kabel und Stecker, Filter, Testausstattung, Sonstiges



AR RF/Microwave Instrumentation

AR Deutschland GmbH
Theodor-Heuss-Strasse 38, 61118 Bad Vilbel; Germany
+49 6101 80270-0; Thomas Modenbach
ardeinfo@arworld.us; www.ar-deutschland.com
Produkte und Services: Verstärker, Antennen, Kabel und Stecker, Abgeschirmte Räume und Gehäuse, Überspannung und Einschaltstöße, Testausstattung

Arrow Europe

Im Gefierth 11a, 63303 Dreieich, Deutschland
0180 2020 112 (0.06 Euro/call);
www.arroweurope.com
Produkte und Services: Ferrite, Kabel und Steckverbinder, Power Applications

Atmel MARCOM

74072 Heilbronn, CA, Deutschland
+49(0)7131 672081
www.atmel.com/ad/automotive
Produkte und Services: Testausstattung

B

Bajog electronic GmbH

Mühlstraße 4, Pilsting, 94431 Deutschland;
+49(0)9953 30020; Fax: +49(0)9953 300213
info@bajog.de; www.bajog.de
Produkte und Services: Filter

BLOCK Transformatoren-Elektronik GmbH & Co. KG

Max-Planck-Str. 36-46, 27283 Verden, Deutschland;
+49(0)4231 6780; Fax: +49(0)4231 678177
Jens Kramer, jens.kramer@block-trafo.de
www.block-trafo.de
Produkte und Services: Filter

Boger Electronics

Grundesch 15, Aulendorf, D-88326, Deutschland
+49(0)1175 25451; Fax: +49(0)1175 252382
info@bogger.de; www.bogger.de
Produkte und Services: Verstärker, Testen

BONN Elektronik GmbH

Ohmstr. 11, 83607 Holzkirchen, Deutschland
+49 (0)8024 608 83-0; Fax: +49 (0)8024 608 83-10
Gerald Puchbauer, gerald.puchbauer@bonn-elektronik.com; www.bonn-elektronik.com
Produkte und Services: Verstärker, Filter

Bundesnetzagentur

Canisiusstr. 21, 55122 Mainz, INTL, Deutschland
+49(0) 6131 180; 411.
postfach2@bnetza.de; www.bundesnetzagentur.de
Produkte und Services: CE marking

C

Carl Zeiss Optronics GmbH

73446 Oberkochen, Deutschland
+49(0)7364 206530; Fax: +49(0)7364 203697

optronics@optronics.zeiss.com; www.zeiss.de
Produkte und Services: Verstärker

Carlisle Interconnect Technologies

United Kingdom
+44-7817-731-000;
Andy Bowne, Andy.Bowne@carlisleit.com;
www.CarlisleIT.com
Produkte und Services: Filter

Cascade Microtech GmbH

Heisenbergbogen 1
85609, Aschheim / Dornach, Deutschland
+49(0)8990 901950; Fax: +49(0)8990 90195 29
www.cmicro.com
Produkte und Services: Testen

CEcert GmbH

Alter Holzhafen 19/19a, D-23966 Wismar, Deutschland;
+49(0)3841 303050; Fax: +49(0)3841 3030518;
info@cecert.de; www.cecert.de
Produkte und Services: Testen

CETECOM GmbH

Im Teelbruch 116, 45219 Essen, Deutschland;
+49(0)2054 9519 0; Fax: +49(0)2054 9519 997
info@cetecom.com; www.cetecom.com
Produkte und Services: Testen

Communications & Power Industries International

Ismaning, Bayern, Deutschland
+49(0)8945 87370; Fax: +49(0)8945 873745;
Wolfgang Tschunke; wolfgang.tschunke@cpii.de;
Roman Jaresch; roman.jaresch@cpii.de;
www.cpii.com
Produkte und Services: Verstärker

EMCO Elektronik GmbH

Bunsenstrasse 5, D-82152 Planegg
+49 (0)89-895565-25, dwaser@emco-elektronik.de
www.comtest.eu
Produkte und Services: Absorberhallen, Hallräume, HF-geschirmte Räume und Türen, Hybrid & Mikrowelle Absorber

CONEC Elektronische Bauelemente GmbH

Ostenfeldmark 16, 59557 Lippstadt, Deutschland
+49 2941/765-0; Fax: +49 2941/765-65
info@conec.de; www.conec.de
Produkte und Services: Steckverbinder

CST - Computer Simulation Technology

Bad Nauheimer Str. 19, Darmstadt, 64289, Deutschland;
+49(0)6151 7303 0; Fax: +49(0)6151 7303 100
info@cst.com; www.cst.com
Produkte und Services: Testen, Antennen, Abschirmung, Kabel und Stecker

E

Eberspacher Electronics

Robert Bosch Strasse 6, Goepplingen, 73037 Deutschland
+49(0)7161 9559206; Fax: +49(0)7161 9559455
Christian Huschle christian.huschle@eberspacher.com;
www.eberspacher.com
Produkte und Services: Testen

EMC Bundles

Measurement Equipment for Pre-Compliance Tests



Save Lab Cost!

Make your own EMC pre-compliance Tests now

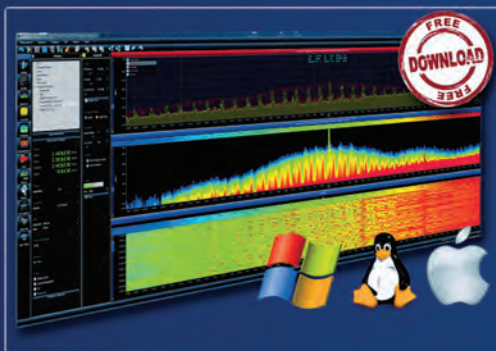
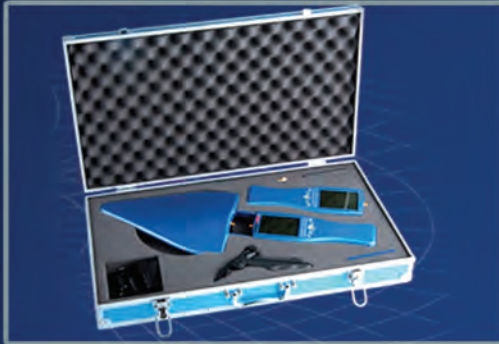

Aaronia EMC Test Sets

1Hz - 18GHz, EN55011, EN55022, CISPR etc.

- Frequency Range: 1Hz - 9,4GHz
- Allows affordable, in-house pre-compliance tests
- Suitable for radiated and conducted emission
- Ultra low noise floor of typ. -170dBm (Hz)
- High accuracy of +/- 1dB
- Including extensive Near Field Probe Set
- Comes with test antennas for radiated emission
- Ready to start, incl. all cables, software etc.
- 10 years Warranty & Made in Germany

- Perfect for EMC Pre-Compliance measurement
- Pinpointing interference sources
- Verification of shielding and filtering
- Identifying faulty components
- Detecting circuitry overly sensitive to interference

All bundles including **FREE** EMC Analyzer-Software for MAC-OS, LINUX, Windows and all needed cables & accessories. Aaronia garants 10 years warranty.

MADE IN GERMANY

AARONIA AG
WWW.AARONIA.DE

EM Software & Systems GmbH

Otto-Lilienthal-Strasse 36, D-71034 Böblingen, Deutschland;
+49(0)7031 7145200; Fax: +49(0)7031 7145249;
Dr. U. Jakobus; info@emss.de; www.emss.de
Produkte und Services: Testausstattung, Testen



EM Test GmbH

AMETEK CTS GmbH, Lünener Str. 211, 59174 Kamen, Deutschland; + 49 2307 26070-0, Fax: +49 2307 17050, info.emtest@ametek.de, www.ametek-cts.com
Produkte und Services: Innovative Prüf- und Testsysteme für leitungsgedundene Störfestigkeits-Prüfungen, ESD, Transienten, Automotive, Harmonics & Flicker, AC/DC-Quellen, Safetytests, akkreditierte Kalibrierungen, EMV-Prüflabor, Seminare, Workshops, Consulting

EMC Partner

H+H High Voltage Technology GmbH, Herr Volker Henker, Im kurzen Busch 15, DE - 58640 Iserlohn Deutschland; +49(0)2371 78530; Fax: +49(0)2371 157722; info@hundh-highvoltage.de; www.hundh-highvoltage.de
Produkte und Services: Überspannung und Einschaltstöße, Testausstattung

EMC Testhaus Schreiber GmbH

Eiserfelderstrasse 316, D-57080 Siegen, Deutschland; +49(0)2713 8270; Fax: +49(0)2713 82758; info@emc-testhaus.de; www.emc-testhaus.de
Produkte und Services: Testen

EMCO Elektronik GmbH

Bunsenstrasse 5, 82152 Planegg, Deutschland; +49(0)8989 55650; +49(0)8989 590376; Diego Waser; info@emco-elektronik.de; www.emco-elektronik.de
Produkte und Services: Verstärker, Antennen, Kabel und Stecker, Testausstattung

EMC Test NRW GmbH

Emil-Figge-Str. 76, Dortmund, D-44227, Deutschland; +49(0)2319 742750; Fax: +49(0)2319 742755; Monika Przybilla, przybilla@emc-test.de; www.emc-test.de
Produkte und Services: Testing

EMI-tec GmbH

Motzener Str 17, Berlin, 12277, Deutschland +49(0)3072 39490; Fax: +49(0)3072 394919
Robert Kahl, info@emi-tec.de
www.emi-tec.de
Produkte und Services: Testen

emscreen GmbH

Wallbergstraße 7, D-82024 Taufkirchen, Deutschland; +49(0)8961 41710; Fax: +49(0)8961 417171
info@emscreen.de
www.emscreen.com
Produkte und Services: Abgeschirmte Räume und Gehäuse, Abschirmung

emv - Elektronische

Melßgeräte Vertriebs GmbH
Wallbergstraße 7, 82024 Taufkirchen Deutschland; +49(0)8961 41710; Fax: +49(0)8961 417171
Ariane Wahrmann; info@emvgmbh.de
www.emvgmbh.com
Produkte und Services: Testausstattung, Verstärker, Antennen

EMV Testhaus GmbH

Gustav-Hertz-Straße 35, Straubing, D-94315, Deutschland; +49(0)9421 568680; Fax: +49(0)9421 56868100
Charlotte Klein, charlotte.klein@emv-testhaus.com
www.emv-testhaus.com
Produkte und Services: Testen



ETS-Lindgren

emv GmbH - an ETS-Lindgren company - Wallbergstraße 7 82024 Taufkirchen
+49 (0) 89 614171-0; Fax: +49 (0) 89 614171-0; emv@ets-lindgren.com; www.emvgmbh.de
Produkte und Services: Verstärker, Antennen, Ferrite, Filter, geschirmte Räume und Gehäuse, RFI / EMI-Signalgeneratoren, Test Instrumentation, Diverses

euro EMC GmbH

Schlossstr. 4, Oberkoellnbach, 84103 Postau, Deutschland +49(0)8774 968550; Fax: +49(0)8774 968559; info@euro-emc.com; www.emc-positioning.de
Produkte und Services: Antennen, Verstärker

F



Fair-Rite Products Corp.

Industrial Electronics, Hauptstr. 71 - 79 D-65760 Eschborn, Deutschland +49(0)6196 927900; Fax: +49(0)6196 927929
w.uhlig@industrialelectronics.de
Produkte und Services: Antennas, Ferrites

Schaffner Elektronik GmbH

Schoemperienstrasse 12B D-76185 Karlsruhe Deutschland +49(0)7215 6910; Fax: +49(0) 7215 69110
germany.sales@schaffner.com; www.fair-rite.com
Produkte und Services: Ferrit, Filter, Abgeschirmte Räume und Gehäuse, Abschirmung

Federal-Mogul Corporation

Bürgermeister-Schmidt-Straße 17, 51399 Burscheid, +49 2174 69 1360; Fax: +49 2174 696 1360
systems.protection@federalmogul.com
www.federalmogul.com/sp
Produkte und Services: Shielded Cable Assemblies & Gurte, Shielded Conduits, Shielded Tubing

Feuerherdt GmbH

Motzener Str. 26b, 12277 Berlin, Deutschland; +49(0)30 710 96 45 52; Fax: +49(0)30 710 96 45 99
Judith Feuerherdt, emc@feuerherdt.de
www.shielding-online.com
Produkte und Services: Conductive Materials, Shielding

Frankonia GmbH

Industriestr. 16, Heideck, 91180, Deutschland; +49(0)9177 98500; Fax: +49(0)9177 98520
Andrea Bodhee, info@frankonia-emc.com
www.frankoniagroup.com
Produkte und Services: Shielded Rooms & Enclosures, Shielding, Test Instrumentation

FS Antennentechnik GmbH

Morsestr. 6, D-85716 Unterschleißheim, Deutschland; +49(0)8937 44860; Fax: +49(0)8937 448655

Our Power Inductor family from

small and filigree to

LARGE and POWERFUL

- Available from stock
- Free samples within 24 hrs
- Design kits with free refills
- Software tools for product selection
- On-site Design-In consultations
- IC reference designs

No "next generation" issues!



www.we-online.com

FUTURE PROOF
BY UPGRADING

RINGWAVE
6,000 V 

em.safe
EUT-PROTECTION

em.flow
INTUITIVE OPERATION

MAGNETIC FIELD
IEC/EN 

POWER FAIL
300 V 

SURGE
7,000 V 

EFT/BURST
5,500 V 

THE POWER PACKAGE!

UCS 500N7 & CNI 503Nx

READY FOR
HYBRID
AND E-VEHICLES

Up to 3 * 690 V AC
and 1000 V DC/200 A

Compliant with:

- > ANSI/IEEE C62.41
- > IEC 61000-4-4, -5, -8, -9, -11
- > IEC 61000-4-12
- > IEC 61000-4-29
- > IEC 61851-21, Ed 2, Part 21
- > ECE-Regulation No. 10

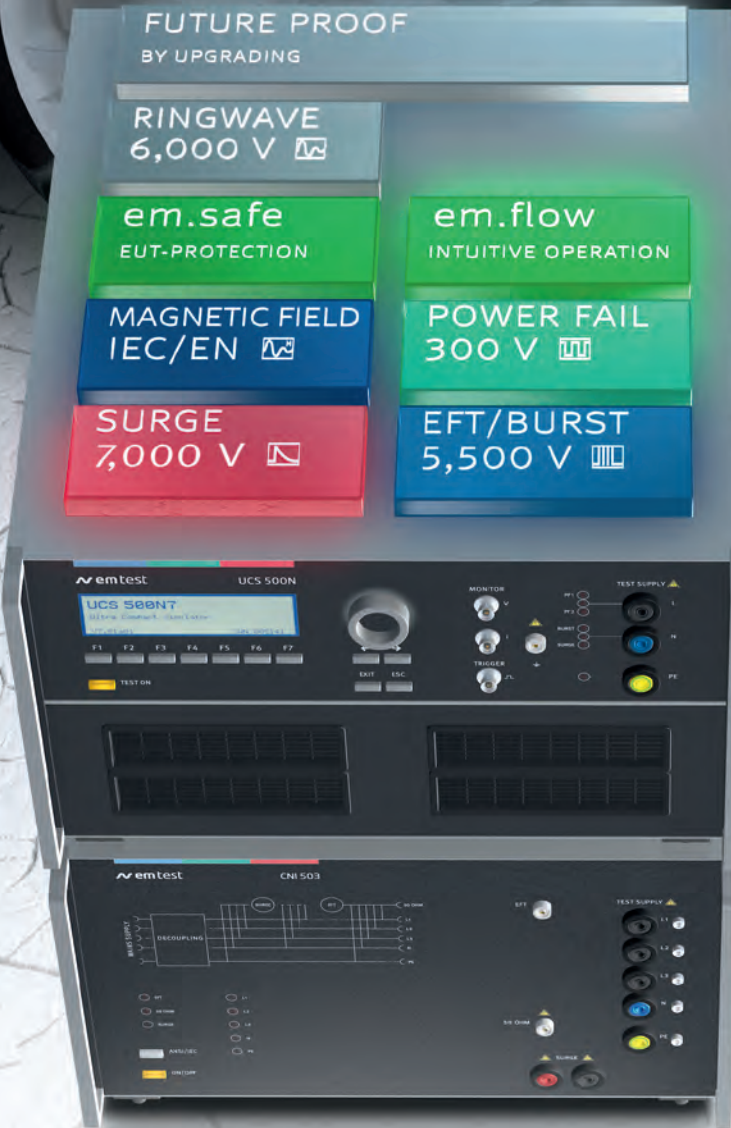

Your partner for all your needs throughout EUROPE:

EM TEST GmbH › Lünener Strasse 211 › 59174 Kamen › Deutschland
Tel.: +49 (0) 2307/26070-0 › Fax: +49 (0) 2307/17050
E-mail: info.emtest@ametek.de



info@fsant.de; www.fsant.de
 Produkte und Services: Antennen

FUSS-EMV

Johann-Hittorf-Straße 6, D-12489 Berlin, Deutschland
 +49(0)3040 44004, Fax: +49(0)3040 43150
 info@tdemi.com; www.fuss-emv.de
 Produkte und Services: Filter

G

GAUSS Instruments

Agnes-Pockels-Bogen 1, 80992 Munich, Germany
 +49 89 54 04 699 0; Fax: +49 89 54 04 699 29
 info@tdemi.com; www.gauss-instruments.com
 Produkte und Services: Test Instrumentation, EMI Receiver,
 EMI Test Software, EMV-Messgeräte, EMV Testsoftware

germania elektronik GmbH

Gutenbergring 41, 22848 Norderstedt, Deutschland
 +49(0)4059 35580; Fax: +49(0)4059 355820
 info@germania-elektronik.de
 www.germania-elektronik.de
 Produkte und Services: Abschirmung,
 Leitungsmaterialien, Ferrit, Filter

GIGACOMP GmbH

Richard-Wagner-Str. 31, D-82049 Pullach, Deutschland;
 +49(0)8932 208957; Fax: +49(0)8932 208958
 info@gigacomp.de; www.gigacomp.de
 Produkte und Services: Testausstattung

Gowanda Electronics

ACAL BFI Germany GmbH; Assar-Gabrielsson-Strasse 1,

Dietzenbach, Deutschland, D-63128
 +49 6074 4098 0; Fax: +49 6074 4098 110
 ipe.de@bfioptilas.com; www.bfioptilas.com
 Produkte und Services: Induktivitäten

Rossmann Electronic GmbH

Georg-Grobl-Strasse 11, Diessen, 86911, Deutschland
 +49 8807 94994 0; Fax: 49 8807 94994 29
 info@rossmannweb.de; www.rossmannweb.de.
 Produkte und Services: Induktivitäten

SK Trade GmbH

Behringersdorfer Str 2, Heroldsberg,
 D-90562; Deutschland
 +49 911 5187080; Fax: +49 911 5187081
 sktrade@t-online.de; www.sktrade.de
 Produkte und Services: Induktivitäten

H

H+H High Voltage Technology GmbH

Im kurzen Busch 15, D-58640 Iserlohn, Deutschland;
 +49(0)2371 7853 0; Fax: +49(0)2371 7853 28;
 Klaus Hornickel, Managing Director;
 info@hundh-highvoltage.de;
 www.hundh-highvoltage.de
 Produkte und Services: Testausstattung

HF-SHIELDING Joachim Broede GmbH

Industriestraße 6, D-49170 Hagen a.T.W., Deutschland;
 +49(0)5405 999904; Fax: +49(0)5405 999906
 broede@hf-shielding.de; www.hf-shielding.de
 Produkte und Services: Testen

HILO-TEST GmbH

E. Pohlner, Hennebergstr. 6,
 D - 76131 Karlsruhe, Deutschland
 +49-721-931 090; Fax: +49-721-931 0939
 info@hilo-test.de; www.hilo-test.de
 Produkte und Services: Testausstattung

Hirschmann Car Communication GmbH

Stuttgarter Straße 45-51, 72654
 Neckartenzlingen, Deutschland;
 +49 (0) 7127 14-0; Fax: +49 (0) 7127 14-1428
 info@hirschmann-car.com
 www.hirschmann-car.com
 Produkte und Services: Testen

I

i. thomas gmbh

An der B73 - 200a, D-21684 Stade, Deutschland;
 +49(0)4141 82920; Fax: +49(0)4141 84461;
 www.schirmkabinen.de
 Produkte und Services: Filter, Abschirmung, Software

IBH Elektrotechnik GmbH

Gutenbergring 35, D-22848 Norderstedt, INTL,
 Deutschland;
 +49(0)40 52 30 52 0; Fax: +49(0)40 523 97 09;
 Michaela Kluckert, mkluckert@ibh-elektrotechnik.de;
 www.ibh-elektrotechnik.de
 Produkte und Services: Kabel und Stecker



RF/Microwave Amplifiers

IFI - Instruments for Industry

AMETEK CTS GmbH, Lünener Str. 211, 59174 Kamen,
 Deutschland; + 49 2307 26070-0, Fax: +49 2307 17050,
 sales.cts@ametek.com, www.ametek-cts.com
 Produkte und Services: Leistungsverstärker in Mikrowellen und HF-Bereich (Tetrode Tubes, Solid State and TWT) bis 40 GHz

IMST GmbH

Carl-Friedrich-Gauß-Str. 2-4-4, 47475,
 Kamp-Lintfort, Deutschland
 +49(0)2842 981 0; Fax: +49 2842 981 199
 borkes@imst.com; marketing@imst.com
 www.imst.com
 Produkte und Services: Software

innco-systems GmbH

Erlenweg 12, 92521 Schwarzenfeld, Deutschland
 +49 9435 301659-0; Fax: +49 9435 301659-99
 info@inncosystems.com
 hoelzl@inncosystems.com; www.innco-systems.com
 Produkte und Services: EMV Positionierer – Drehtische & Antennen Masten

Industrial Electronics

Rudolf-Diesel-Str. 2a D-65719 Hofheim-Wallau
 +49 (0) 6122 / 7 26 60-0; Fax: +49 (0) 6122 / 7 26 60-29
 a.keenan@ie4u.de; w.uhlig@ie4u.de; www.ie4u.de
 Produkte und Services: Ferrite, Kabel und Steckverbinder,
 Power Applications

Instec Filters

ACAL BFI GmbH; Assar Gabrielsson Straße 1,
 Dietzenbach, D-63128, Deutschland
 +49 (0) 6074 4098 113; Fax: +49 (0) 6074 81 20 20
 Kerstin Reinhardt, kerstin.reinhardt@bfioptilas.com
 www.bfioptilas.com
 Produkte und Services: Filters

A.H. Systems, inc.



Represented by



TEL: 49 7141-2858.20
 FAX: 49 7141-2858.29
 http://www.pn-com.de/
 info@pn-com.de

Austria Germany Switzerland



A.H. Systems
 http://www.AHSystems.com

Our expertise takes you to the top. EMC solutions from Rohde & Schwarz.

We provide everything you need for development, precompliance and compliance measurements to ensure successful EMC certification.

- | Exceptionally fast EMI test receivers
- | Efficient diagnostic tools for detecting EMI
- | EMC software packages for interactive and fully automatic measurements
- | Wide range of accessories for performing EMI measurements
- | Compact and modular broadband amplifiers
- | RF shielded chambers
- | Complete EMC test systems

For more information, visit:

www.rohde-schwarz.com/ad/emc



ROHDE & SCHWARZ

J

Jacob GmbH

Elektrotechnische Fabrik, Gottlieb-Daimler-Str. 11, D-71394 Kernen, Deutschland
+49 (0)7151 40110; Fax: +49 (0)7151 4011 49
jacob@jacob-gmbh.de; www.jacob-gmbh.de
Produkte und Services: Testausstattung

JiangSu WEMC Technology Co., Ltd.

No. 8, Jian Ye Road, TianMu Lake Industrial Park, LiYang Jiangsu, 213300, China
+86 519 8746 7888; Fax: +86 519 8746 5666
Xiao Wei; weiyi@wemctech.com
www.wemctech.com
Products and Services: Filters

K

KE Kitagawa GmbH

Elbinger Straße 3-5, D-63110 Rodgau-Jügesheim, Deutschland
+49(0)6106 8524 0; Fax: +49(0)6106 85 2430
sales@kitagawa.de
www.kitagawa.de
Produkte und Services: Ferrit

L

Langer EMV-Technik GmbH

Noethnitzer Hang 31, Bannewitz D01728, Deutschland
+49(0)3514 3009323
michak@langer-emv.de; www.langer-emv.de

Produkte und Services: Testausstattung, Pre-compliance EMC engineering services, Measurement software, EMC pre-test equipments, Test and measurement, Training

Luethi Elektronik-Feinmechanik AG

Parkstrasse 6, 4402 Frenkendorf / BL, Deutschland;
+49(0)6190 21210; Fax: +49(0)6190 21211;
www.luethi-ag.ch
Produkte und Services: Testausstattung

M

Maschek Elektronik

Adolf-Scholz-Allee 4a, 86825 Bad Wörishofen, Deutschland
+49(0)8247 959807; Fax: +49(0)8247 959809
info@maschek.de; www.maschek.de
Produkte und Services: Testausstattung

maturò GmbH

Bahnhofstr. 26, 92536, Pfreimd, Deutschland
+49(0)9606 9239130; Fax: 49(0)9606 92391329
Markus Saller; m.saller@maturò-gmbh.de
www.maturò-gmbh.de
Produkte und Services: Antennen, Testen

MB-technology GmbH

MBtech EMC GmbH Heerstraße 100
71332 Waiblingen, Deutschland
+49(0)7031 6863000; Fax: +49(0)7031 6864500
media@mbtech-group.com; www.mbtech-group.com
Produkte und Services: Testen

Mesago Messe Frankfurt GmbH

Rotebuehlstraße 83-85, Stuttgart, 70178, Deutschland
+49(0)7116 19462 0; Fax: +49(0) 7116 1946 91
www.mesago-online.de
Produkte und Services: Events

Mician GmbH

Schlachte 21, 28195 Bremen, Deutschland
+49(0)4211 6899351; Fax: +49(0)4211 68993 52
sales@mician.com; www.mician.com
Produkte und Services: Software



RF/Microwave Amplifiers

MILMEGA

AMETEK CTS GmbH, Lünener Str. 211, 59174 Kamen, Deutschland; + 49 2307 26070-0, Fax: +49 2307 17050, sales.cts@ametek.com, www.ametek-cts.com
Produkte und Services: High Power RF and Microwave solid state amplifiers. Frequency range 80MHz up to 6GHz, with output powers to 1kW

MOOSER Consulting GmbH

Amtmannstraße 5a, 82544 Egling/Thanning, Deutschland
+49(0)8176 92250; Fax: +49(0)8176 92252
Mario Kantner; m.kantner@mooser-emctechnik.de
http://mooser-consulting.de
Produkte und Services: Verstärker, Testen

MTS Systemtechnik GmbH

Gewerbepark Ost 8, D-86690 Mertingen, Deutschland;
+49(0)9078 912940, Fax: +49(0)9078 912947 0
info@mts-systemtechnik.de
www.mts-systemtechnik.de
Produkte und Services: Antennen, Testausstattung

N



Narda Safety Test Solutions GmbH

EMCO Elektronik GmbH
Bunsenstrasse 5, 82152 Planegg / Germany
Phone: +49-89-895 56 50, Fax: +49-89-895 90 376
http://www.emco-elektronik.de/
email info@emco-elektronik.de
Produkte und Services: Antennen, Testausstattung, Sonstiges

Neosid Pemetzrieder GmbH & Co. KG

P.O. Box 1354, D-58543 Halver, Deutschland
+49(0)2353 710; Fax: +49(0)2353 7154
sales@neosid.de; www.neosid.de
Produkte und Services: Ferrit, Filter

Neuhaus Elektronik GmbH

Drontheimer Str. 21, D-13359 Berlin, Deutschland;
+49(0)3049 76950; Fax: +49(0)3049 769530
neuhaus-elektronik@t-online.de
www.neuhaus-elektronik.de
Produkte und Services: Leitungsmaterialien

Nexio

Emco Elektronik, Bunsenstr.5, D-82152 Planegg, Deutschland
+49(0)8989 55650; Fax: +49(0)8989 590376
info@emco-elektronik.de; www.emco-elektronik.de
Produkte und Services: Testausstattung, Filter, Überspannung und Einschaltstöße

Fair-Rite Products Corp.
Design, Develop, Deliver Your Signal Solution®

THE FIRST TO INTRODUCE ANOTHER INNOVATIVE SOLUTION TO THE ELECTRONICS INDUSTRY!

75 MATERIAL

- Providing enhanced impedance between 100 kHz and 5MHz.
- Suppresses conducted EMI noise from sources such as switching power supplies.
- Comparable performance in both solid and Snap-It forms to minimize development time!

Visit us at www.fair-rite.com
or contact your local sales representative
or authorized distributor for more information

Your Partner to EMC certification



Fabric-Over-Foam EMI Gaskets

EF: Halogen Free Fabric-Over-Foam

EEH: Environmental/EMI Dual Gaskets

CF: High Resilience Conductive Foam

DYNASHEAR™: Faceplate gaskets

Beryllium Copper Fingerstock

Conductive Elastomers

Honeycomb Vent Panels

Shielded Windows and Optical Filters

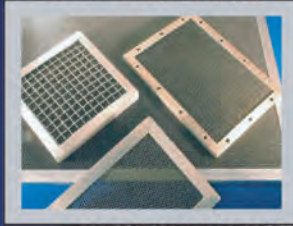
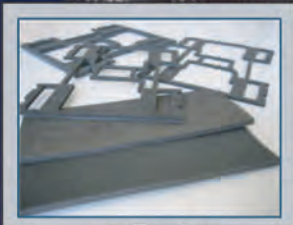

Often copied, never equaled! Schlegel Electronic Materials, inventor of Fabric-Over-Foam gasket technology, provides a wide variety of solutions to contain radiated emission and decrease susceptibility of electronic systems. Our quality procedures ensure your products to be in full compliance with all environmental directives (REACH, ROHS) which makes our EMI gaskets safe and easy to incorporate into any existing or new program. For any inquiries please contact us at NORTH AMERICA : schlegelemi.na@schlegelemi.com, EUROPE: schlegelbe@schlegelemi.com, ASIA : schlegelemi@emeigroup.com.

NEW SCHLEGEL ELECTRONIC MATERIALS NOW OFFERS **OptiM™**, A COMPLETE RANGE OF THERMAL INTERFACE MATERIALS **NEW**

Schegel Electronic Materials
Slijpesteenweg 28
8432 Middelkerke (Leffinge)
Belgium
Tel: +32 59 560 270
Fax: +32 59 560 271

www.schlegelemi.com

P

PFLITSCH GmbH & Co. KG

Ernst-Pflitsch-Straße 1 Industriegebiet, Nord 1,
D-42499 Hückeswagen, Deutschland
+49(0)2192 9110; Fax: +49(0)2192 911220
info@pflitsch.de; www.pflitsch.de
Produkte und Services: Kabel und Stecker

Phoenix Testlab GmbH

Königswinkel 10, D-32825 Blomberg, Deutschland
+49(0)5235 95000; Fax: 49(0)5235 950010
office@phoenix-testlab.de
www.phoenix-testlab.de
Produkte und Services: Testen

Pontis - Audiv GmbH

Audio GmbH, Irrenloher Damm 17, 92521
Schwarzenfeld, Deutschland;
+49(0)9435 54190; Fax: +49(0)9435 541919
info@audivo.com; www.audivo.com
Produkte und Services: Abschirmung

PSC

Industrivej 13, DK-9700 Brønderslev
+45 9882 2999
jo@psc.dk; www.psc.dk
Produkte und Services: Abschirmung

R



A division of **Astrodyne**
Now you have power.

Radius Power

Eurocomp Elektronik GmbH
Nöerdlicher Park 17, D-61231 Bad Nauheim Germany
+49 7146 860660 Fax: +49 7146 860662
Mobile: +49 171 3584554
Dieter Kunick; d.kunick@eurocomp.de
Produkte und Services: EMI/EMC/RFI Filters



ROHDE & SCHWARZ

Rohde & Schwarz Vertriebs-GmbH

Mühlendorfstrasse 15, 81671 München
+49 (0) 89 4129 12345; Fax +49 (0) 89 4129 13777
direct@rohde-schwarz.com; www.rohde-schwarz.de
Web-Store: www.rohde-schwarz.de/surf-in
Produkte und Services: EMV Messgeräte und Zubehör,
Breitband Leistungsverstärker, EMV Testsoftware, Schlüs-
selfertige Testsystem-Lösungen

ROLEC GEHÄUSE-Systeme GmbH

Kreuzbreite 2, 31737 Rinteln, Deutschland
+49(0)5751 40030; www.rolec-enclosures.co.uk
Produkte und Services: Abschirmte Räume
und Gehäuse

S



Schlegel Electronic Materials

Electrade GmbH, Lochhamer Schlag 10b, 82166
Graefelfing, Deutschland
+49(0)8989 81050; Fax: +49(0)8985 44922
Anfrage@electrade.com; www.electrade.com
Produkte und Services: Leitungsmaterialien,
Abschirmung

Schlenk Metallfolien GmbH & Co. KG

Barnsdorfer Hauptstr. 5, D-91154 Roth, Deutschland
+49(0)9171 808 0; Fax: +49(0)9171 808200
Gerhard Loeckler, gerhard.loeckler@schlenk.de
www.schlenk.de
Produkte und Services: Abschirmung

Schlöder GmbH

Hauptstrasse 71, D-75210, Keltern-Weiler, Deutschland;
+49(0)7236 93960; Fax: +49(0)7236 939690
Friedrich Schloeder, info@schloeder-emv.de
www.schloeder-emv.de
Produkte und Services: Testen, Testausstattung

Schwarzbeck Mess - Elektronik

An der Klinge 29, D 69250, Schönau, Deutschland
+49(0)6228 1001; Fax: +49(0)6228 1003
info@schwarzbeck.de; www.schwarzbeck.de
Produkte und Services: Antennen, Testausstattung

ServiceForce.Com GmbH

Kleyerstraße 92, 60326, Frankfurt am
Main, Deutschland
+49(0)6936 50905500; www.serviceforce-com.de
Produkte und Services: Testen

Siemens Energy & Automation EMC-Centre

Guenther-Scharowsky-Str. 21,
Erlangen, D-91058, Deutschland
+49(0)9131 732977; Fax: +49(0)9131 725007
karlheinz.gravenhorst@siemens.com
www.automation.siemens.com
Produkte und Services: Testen

SINUS Electronic GmbH

Schiefweg 10, D-7427 Untereisesheim, Deutschland
+49(0)7132 99690; +49(0)7132 996950
info@sinus-electronic.de; www.sinus-electronic.de
Produkte und Services: Filter, Überspannung und Ein-
schaltstöße

Sonderhoff Chemicals GmbH

Richard-Byrd-Straße 26, 50829 Köln, Deutschland
+49(0)2219 56850; Fax +49(0)2219 5685599
info@sonderhoff.com; www.sonderhoff.com
Produkte und Services: Testen

SOSHIN Electronics Europe GmbH

Westerbachstrasse 32, D-61476, Kronberg
im Taunus, Deutschland
+49(0)6173 993108; Fax: +49(0)6173 993206
www.soshin-ele.com
Produkte und Services: Filter

Spitzenberger & Spies GmbH & Co

Schmidstraße 32-34, D-94234, Viechtach, Deutschland
+49(0)9942 956 0
info@spitzenberger.de; www.spitzenberger.de
Produkte und Services: Verstärker, Testausstattung

Statex Produktions & Vertriebs GmbH

Kleiner Ort 9, 28357 Bremen, Deutschland
+49(0)4212 750479; Fax: +49(0)4212 73643
info@statex.de; www.statex.de
Produkte und Services: Abschirmte Räume und Gehäuse,
Abschirmung, Leitungsmaterialien

Stolberg HF-Technik AG

Muensterau 168, 52224, Stolberg-Vicht, Deutschland
+49(0)2402 997770; Fax: +49(0)2402 99777900
Harald Landes, harald.landess@stolberg-hf.com
www.stolberg-hf.com
Produkte und Services: Verstärker, Kabel und Stecker,
Testausstattung

T

Tactron Elektronik

Bunsenstraße 5 / 11 Stock, 82152 Planegg, Deutschland
+49(0)8989 55690; Fax: +49(0)8985 77605
info@tactron.de TDK; www.tactron.de
Produkte und Services: Software



TDK Electronics Europe

Head Office - Europe
Wanheimer Strasse 57, D-40472 Düsseldorf
+49-(0)211-90770
info@tdkrf.com; www.tdkrf.com
Produkte und Services: Verstärker, Antennen, Ferrit,
Filter, Abschirmte Räume und Gehäuse, Abschirmung,
Testausstattung, Testen

Tech-Etch, Inc.

Feuerherdt GmbH, Motzener Str. 26 b,
12277 Berlin, Deutschland;
+49(0)30 710 96 45 53; Fax: +49(0)30 710 96 45 99
emc@feuerherdt.de; www.tech-etch.com
Produkte und Services: Leitungsmaterialien,
Abschirmung

Telemeter Electronic GmbH

Joseph-Gansler-Straße 10,
D-86609 Donauwörth, Deutschland
+49(0)9067 06930; Fax: +49(0)9067 069350
info@telemeter.de; www.telemeter.info
Produkte und Services: Testen, HF- und Mikrowellen



Advanced Test Solutions for EMC

Teseq GmbH

AMETEK CTS GmbH, Lünener Str. 211, 59174 Kamen,
Deutschland; + 49 2307 26070-0, Fax: +49 2307 17050,
sales.cts@ametek.com, www.ametek-cts.com
Produkte und Services: Verstärker (HF & Mikrowellen),
Antennen, Automotive Systeme, leitungsgebundene Stör-
festigkeit, leitungsgebundene Überspannung & schnelle
Transienten, ESD, Netzoberwellen & Flicker, GTEM Zellen,
HF Immunitäts- und Emissionssysteme, HF Testsoftware,
Kalibration & Service

TESTEC Elektronik GmbH

Westerbachstr. 58,
60489 Frankfurt am Main, Deutschland
+49(0)6994 33350; Fax: +49(0)6994 333555
info@testec.de; www.testec.de
Produkte und Services: Testausstattung

TÜV SÜD SENTON GmbH

Äußere Frühlingstraße 45,
94315 Straubing, Deutschland
+49(0)9421 552222; Fax: +49(0)9421 552299
Stefan Kammerl; senton@tuev-sued.de
www.tuev-sued.de/senton
Produkte und Services: Testen

V

Vacuumschmelze GmbH

Grüner Weg 37, Hanau, D-63450, Deutschland
+49 6181 38-0; Fax: +49(0)6181 382645
info_vertrieb@vacuumschmelze.com
www.vacuumschmelze.com
Produkte und Services: Produkte



Total System Technology®

The ideal choice for a complete EMC solution.

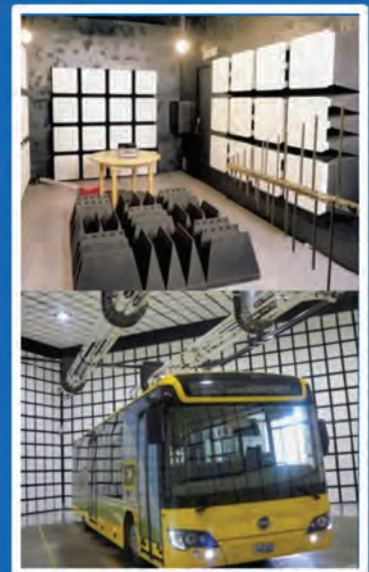

Antennas ■ Chambers ■ Systems ■ Test Products

**TDK offers a single vendor solution for all
your EMC testing needs.**

Please contact us for additional information

www.tdkrfsolutions.com

info@tdkrf.com

W



Würth Elektronik eiSos GmbH & Co. KG

Max-Eyth-Str. 1
DE-74638 Waldenburg, Deutschland
+49 (0) 79 42 945-0; eiSos@we-online.de
Produkte und Services: Ferrit, Kabel und Stecker

Würth Elektronik iBE GmbH

Automotive, Gewerbepark 8, DE-94136
Thyrnau, Deutschland
Tel. +49 (0) 85 01 90 01-100; ibe@we-online.de
Produkte und Services: Ferrit, Kabel und Stecker

ASSOCIATION

**IEEE EMC SOCIETY
CHAPTER GERMANY**

Frank Sabath, Federal Ministry of Defense, Armament
Directorate IV 6, Am Steinberg 9, Garstedt 21441,
Deutschland; +49 4173 58 17 20
Fax: +49 4173 58 17 21; Frank.Sabath@ieee.org

NOTIFIED BODIES

CETECOM GMBH

Im Teelbruch 116, 45219 ESSEN, Deutschland
49 (0) 20 54 95 283; Fax: 49 (0) 20 54 95 19 903;
info@cetecom.com; www.cetecom.de

EMC TEST NRW GMBH

Emil-Figge-Straße 76, 44227 Dortmund, Deutschland;
+49 231 9742750; Fax: +49 231 9742755; service@
emc-test.de; www.emc-test.de

EMCCERT DR. RASEK GMBH

Moggast, Boelwiese 4-8, 91320 Ebermannstadt,
Deutschland; +49 9194 9016; Fax: +49 9194 8125; emc.
cert@emcc.de; www.emcc.d

EUROFINS PRODUCT SERVICE GMBH

Storkower Straße 38C, 15526 Reichenwalde,
Deutschland; +49 33 63 18 88 0; Fax: +49 33 63 18
88 660; ProductTesting-BLN@eurofins.com; www.
eurofins.com

**KRAUSS-MAFFEI WEGMANN
GMBH & CO. KG**

August-Bode-Straße 1, 34127 Kassel, Deutschland; +49
561 105 0; Fax: +49 (561) 1052832;
info@kmweg.de; www.kmweg.de

MIKES-TESTING PARTNERS GMBH

Ohmstrasse 2-4, 94342 Strasskirchen, Deutschland;
+49 (0) 9424 94810; Fax: +49 (0) 9424 9481240 info@
mikes-tp.com; www.mikes-testing-partners.com

PHOENIX TESTLAB GMBH

Köningswinkel 10, 32825 Blomberg, Deutschland; +49
5235 9500 0; Fax: +49 5235 9500 20; office@phoenix-
testlab.de; www.phoenix-testlab.de

SIEMENS AG

San-Carlos-Straße 7, 91058 Erlangen, Deutschland +49
9131 733177; Fax: +49 9131 733265; peter.linnert@
siemens.com; www.siemens.de

**SGS GERMANY GMBH
ZERTIFIZIERUNGSSTELLE MÜNCHEN**

Hofmannstraße 50 81379 München, Deutschland; +49
89 787475132; Fax: +49 89 787475122; melanie.beier@
sgs.com; www.sgs-cqe.de

SONY DEUTSCHLAND GMBH

Hedelfinger Straße 61, 70327 Stuttgart, Deutschland;
+49 (0) 711 5858 0; Fax: +49 (0) 711 5858 235; hubert.
klamm@eu.sony.com; www.stuttgart.sony.de

TÜV RHEINLAND LGA PRODUCTS GMBH

Tillystraße 2, 90431 Nürnberg, Deutschland; +49 0911
6555227; Fax: +49 221 806 3935; ksc@de.tuv.com;
www.de.tuv.com

TÜV SÜD PRODUCT SERVICE GMBH

Ridlerstraße 65, 80339 München, Deutschland;
+49 (0) 89 5008 40; Fax: +49 (0) 89 5008 4222
productservice@tuev-sued.de; www.tuev-sued.de/ps

EMC GLOBAL SOLUTIONS

EMI RECEIVERS & ANALYZERS
RF IMMUNITY SYSTEMS
FIELD PROBES
ANCILLARIES

PIM a brand of **narda** Safety Test Solutions®
a Communications Company

Narda Safety Test Solutions srl
Via Leonardo da Vinci, 21/23, 20090 Segrate (MI) ITALY
Phone: +39 02 26 998 71 - Fax: +39 02 26 998 700
E-Mail: nardait.support@L-3com.com - Website: www.narda-sts.it



Foto: Martin Ebener

“Excellence is not a skill. It is an attitude.”

Ralph Marston

It's the little difference in doing things that creates a big difference. The little difference is the attitude; the big difference is whether excellence is your target or profit maximizing; do the right things even when it's hard! The attitude to excellence determines what and how well we do things. During the completion of your project this attitude causes a chain reaction of positive thoughts and actions. To keep the time line within the size of your budget and achieve the agreed performance and quality is the consequence of this attitude.

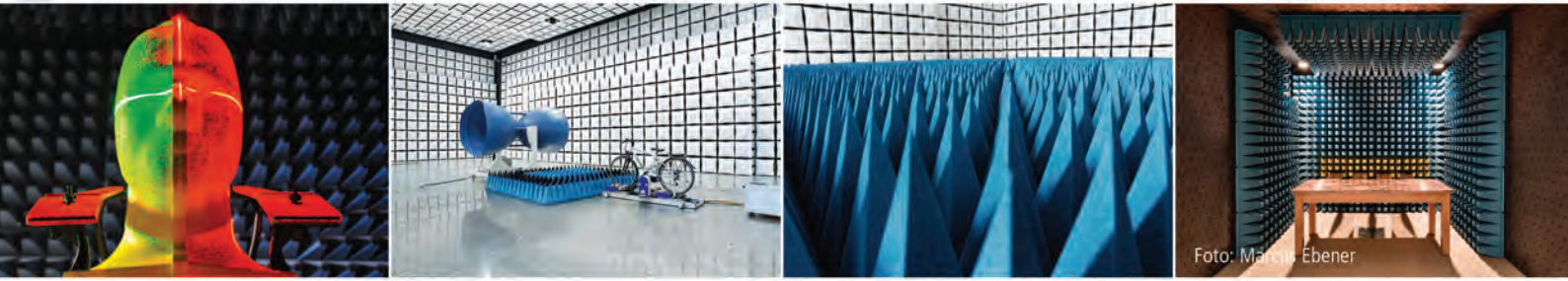
Put your trust in the excellence of a market leader!

Albatross Projects GmbH

Daimlerstrasse 17 · 89564 Nattheim, Germany · Phone +49 7321 730-500
 info@albatross-projects.com · www.albatross-projects.com

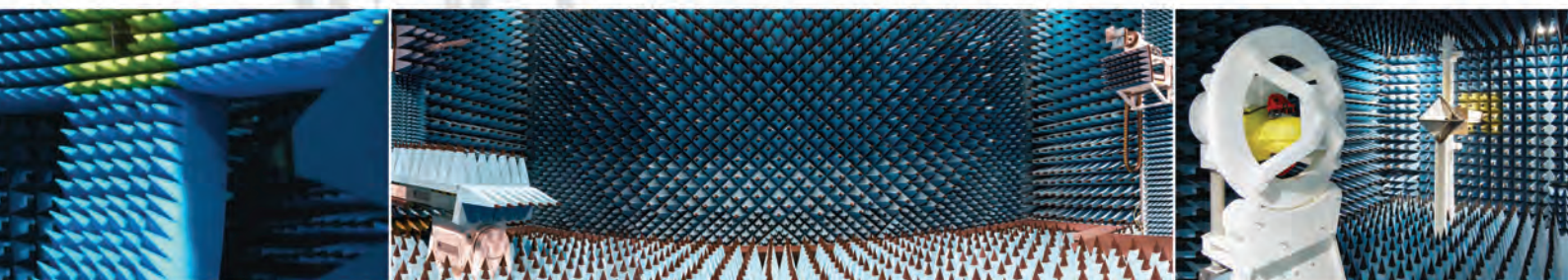

On our client's wavelength

The world of wavelength is our domain. No matter what your RF challenges are, we will capture and absorb all undesirable wavelengths and finetune your anechoic room to realize its' optimal performance. Fire retardancy, high power handling capability, long term stability, REACH and RoHS, we master all these essential characteristics by enhancing the fundamentals and implementing innovative technology.

We are on your wavelength when it comes to our relationship with you too. Dedication to professional service and taking the ownership of the successful completion of your project is in our DNA.

Share with us our commitment to excellence!

E&C Anechoic Chambers N.V.

Nijverheidsstraat 7A · 2260 Westerlo, Belgium · Phone +32 14 595800
 info@ecanechoicchambers.com · www.ecanechoicchambers.com



Messen Unter Störbeeinflussung Signale Fehlerfrei aus dem Prüfling Übertragen

JÖRG HACKER

EMC Engineer
Langer EMV-Technik GmbH

VORWORT:

Üblicherweise wird bei Prüfung der Störfestigkeit auf das Oszillografieren von Signalen des Prüflings verzichtet. Die komplizierten Umgebungsbedingungen in der Absorberhalle bei HF-Einstrahlung bzw. bei Burst- und ESD-Untersuchungen führen zu Fehlmessungen und unerwünschten Beeinflussungen des Prüflings. Deshalb werden Modifikationen am Prüfling nach der Methode „Versuch und Irrtum“ durchgeführt.

Durch geschicktes Messen mit kleinen und störfesten Messsystemen lassen sich diese Schwierigkeiten umgehen. Der Entwickler kann mit diesen Messsystemen an seinem Arbeitsplatz messen und Ursachen für Fehlfunktionen schneller finden. Mit dem gleichen Messaufbau lassen sich Modifikationen und Gegenmaßnahmen am Prüfling leicht und schnell auf ihre Wirksamkeit testen.

1 ZIEL DER MESSUNGEN

1.1 Nachweis der Beeinflussung

Der Nachweis der Beeinflussung des Prüflings erfolgt traditionell durch Beobachten. Der subjektive Faktor bei der Beobachtung zieht Ungenauigkeiten nach sich. Automatische Prüfabläufe sind deshalb nicht möglich. Abhilfe schafft das elektronische Überwachen von Anzeigen oder das genaue Messen von Ausgangssignalen des Prüflings.

1.2 Verfolgen von gestörten Signalen

Die EMV-Praxis ist oft komplex. In einem Prüfling können gleichzeitig an verschiedenen Orten über unterschiedliche Wirkmechanismen Störbeeinflussungen auftreten. Für eine effektive Fehlerbeseitigung ist es unumgänglich, Signale des Prüflings zu Überwachen und ihre Störungen zu analysieren. Durch Störungen können Signale in digitalen wie in analogen Systemen verfälscht werden.

Die Überwachung der Signale des Prüflings mit Messgeräten ermöglicht neben Aussagen zur Fehlerursache auch die Bewertung der Wirksamkeit von EMV-Maßnahmen direkt am Ort der Beeinflussung.

This article discusses EMC Practice – Measurement under Interference and clean transmission of signals from the EUT. It is uncommon to use an oscilloscope to monitor signals from the EUT when testing immunity to interference. The complicated environmental conditions in the anechoic chamber during RF irradiation or burst and ESD tests lead to measuring errors and unwanted interference in the EUT. Modifications to the EUT are accordingly done by “trial and error.” These difficulties can be overcome by careful measurement using small and interference-immune measuring systems, and this article will illustrate how. To read this article in English, visit our website www.interferencetechnology.com.

2 ANFORDERUNGEN AN DIE MESSTECHNIK:

2.1 Allgemeine Anforderungen

Die Einkopplung von Störgrößen z.B. über eine kapazitive Koppelzange am Burstprüfplatz erzeugt im Prüfling physikalische Größen wie Strom, Spannung, Magnetfeld und elektrisches Feld. Deren räumliche Verteilung, Intensität und Orientierung wird durch die geometrische Struktur des Metallsystems des Prüflings und des Messplatzes bestimmt. Sie ist auf Grund der Komplexität des Prüflings kaum vorherzusagen.

Die physikalischen Größen wirken auch auf die Messtechnik wie Tastkopf und Messleitungen ein, dürfen aber keine falschen Messergebnisse hervorrufen. Darum muss die Messtechnik z.B. Feldstärken beherrschen ohne dass Messergebnisse beeinflusst werden.

Zum Beispiel kann bei Tests mit ESD zwischen dem metallischen Gehäuse und dazu isolierter Leiterkarte die gesamte Störspannung anstehen. 5 kV ESD bewirken bei einem Abstand von 5 mm eine Feldstärke von 1 kV/mm, das heißt 1 MV/m!

Der durch den Prüfling fließende Störstrom erzeugt



BILD. 1: Störstrom fließt durch einen galvanisch getrennten Tastkopf

Magnetfelder im Bereich von einigen Millitesla.

Bei HF-Einstrahlung sind die Feldstärken wesentlich geringer und erreichen je nach Prüfanforderung bis 200 V/m.

Für eine fehlerfreie Messung unter diesen Bedingungen ist eine galvanische Trennung zwischen Prüfling und Messgerät erforderlich. Nur so wird der Weg des Stör-

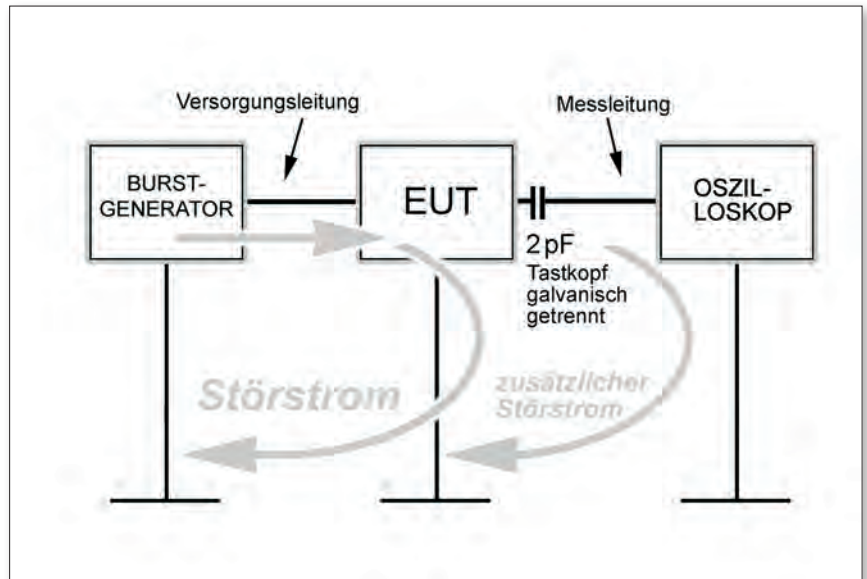
EXZELLENT, WEIL EFFIZIENT! – NSG 4070 MEHR ALS EIN GENERATOR!

Der NSG 4070, ein Multitalent für entwicklungsbegleitende Tests und Normprüfungen nach IEC/EN 61000-4-6 und im Automotive-BCI-Bereich. Wer bisher viel Zeit für die Prüfplatzkalibrierung, die Anbindung der Prüflingsüberwachung oder die Dokumentation aufwenden musste, kann Störfestigkeitsprüfungen nun mit dem NSG 4070 in seiner 3. Generation viel effizienter durchführen. Die weiteren Highlights: EUT-Monitoring-Ergebnisse können während der Prüfung kommentiert werden, die Ausgabe erfolgt im Report. Speichermöglichkeit für Ergebnisse, Konfigurationen und Kalibrierdateien mit bis zu 340 Daten.

Der NSG 4070 auf einen Blick:

- Lösung für IEC/EN 61000-4-6 und Automotive BCI
- Frequenzbereich 9 kHz bis 1 GHz
- Einfache Bedienung über Frontplatte oder Windows-Software
- Anzeige der Kalibrierdaten in graphischer und tabellarischer Form
- Verstärker-Sättigungs-Check
- Verschiedene integrierte Leistungsverstärker bis zu 80 W



Teseq GmbH Berlin Deutschland
T +49 30 5659 8835 F +41 30 5659 8834
desales@teseq.com www.teseq.de

AMETEK
COMPLIANCE TEST SOLUTIONS

Teseq
Advanced Test Solutions for EMC



BILD. 2: System zur Übertragung von Signalen mit einem Sensor über Lichtwellenleiter und einen optischen Empfänger zum Oszilloskop.



BILD. 3: Kleiner, auf der Baugruppe leicht aufzubringender Sensor, der Signale in Lichtsignale wandelt und über LWL an einen optischen Empfänger weiter leitet.

stromes im Prüfling nicht unzulässig verändert. Dabei ist zu beachten, dass z.B. ein zur galvanischen Trennung eingesetzter Optokoppler eine parasitäre Kapazität von einigen pF zwischen Primär - und Sekundärseite besitzt. Vom Aufbau des Prüflings ist es abhängig, inwieweit diese Kapazität unzulässig Störstrom überträgt (Bild 1).

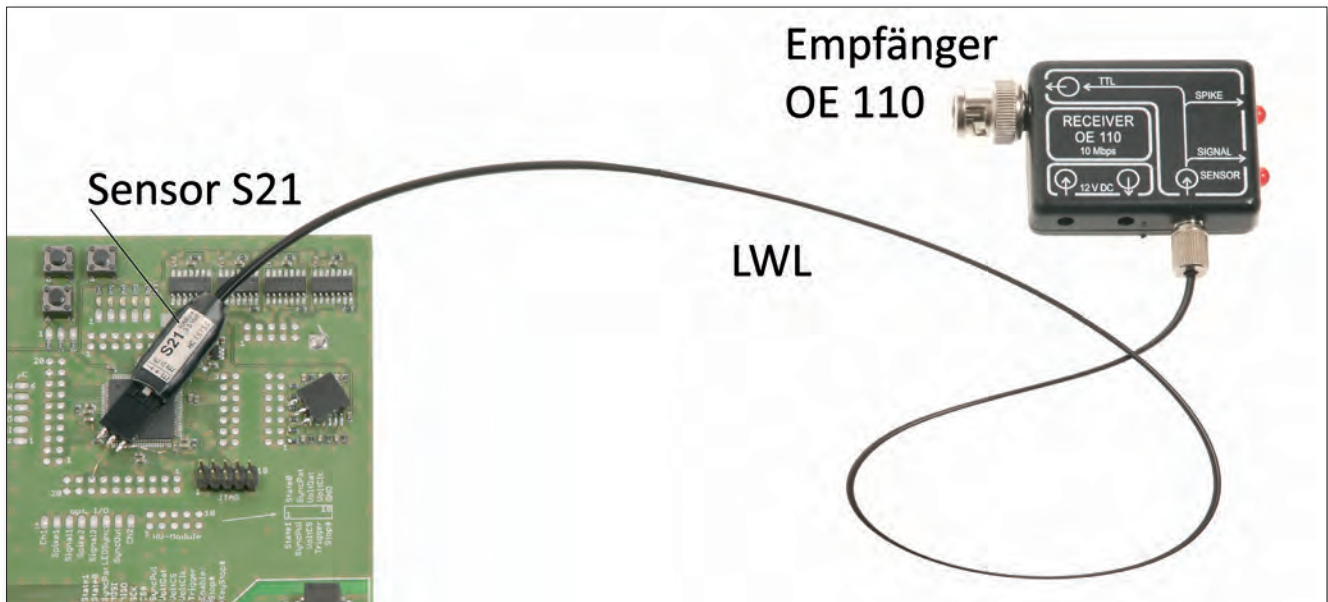
Optimal ist eine Messung über Lichtwellenleiter, da in diesem Fall die parasitäre Kapazität praktisch nicht mehr vorhanden ist. Eine Veränderung der Störfelder durch zusätzliche Kabel ist ausgeschlossen. Es ist jedoch ein Tastkopf erforderlich, der das zu messende Signal in ein Lichtsignal wandelt und selbst so klein ist, dass er die Störfelder nicht unzulässig verformt.

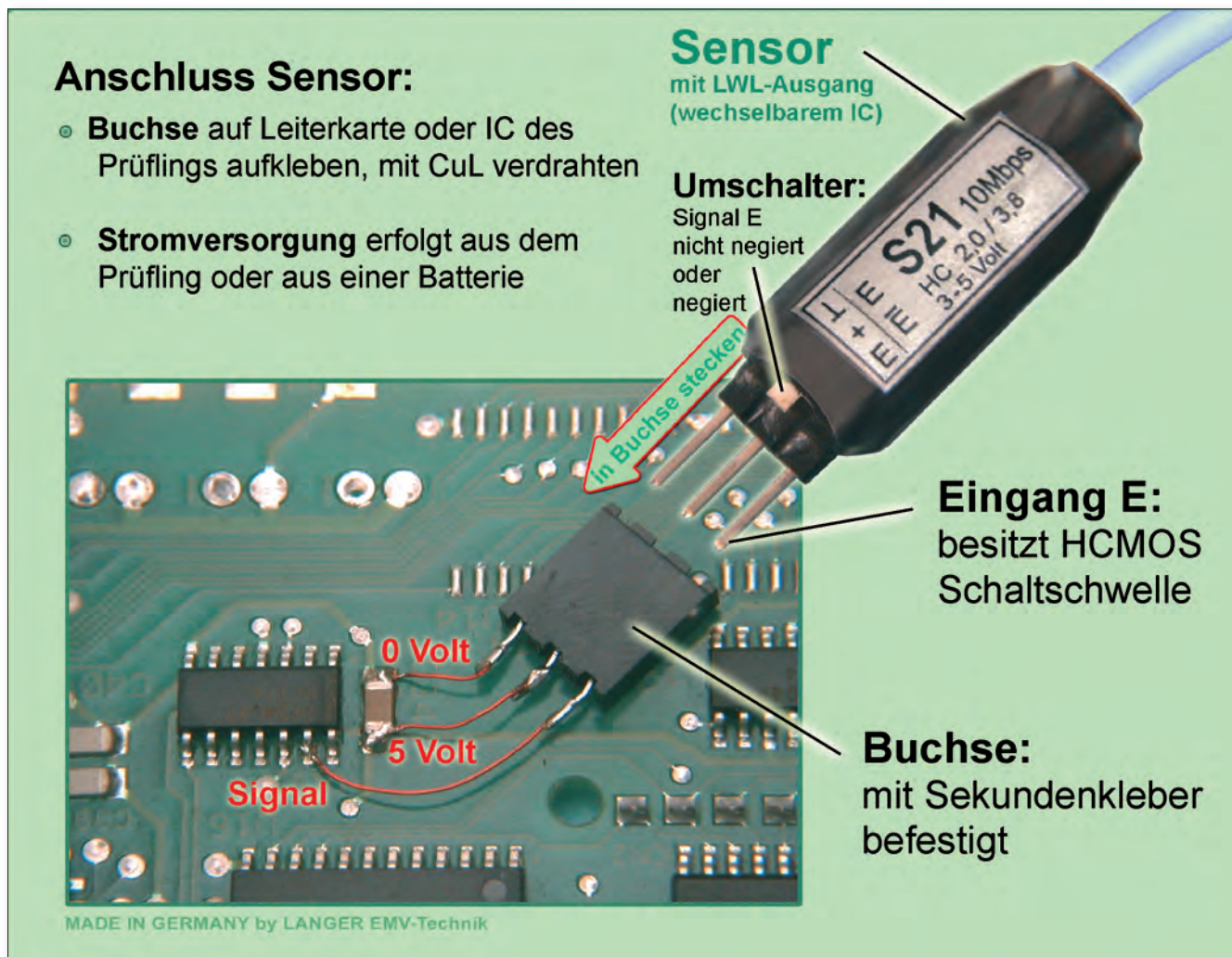

BILD. 4: Messung von Spannungsdifferenzen über dem GND-System

2.2 MESSUNG VON ANALOGEN SIGNALEN

2.2.1

Beeinflussungsmechanismus

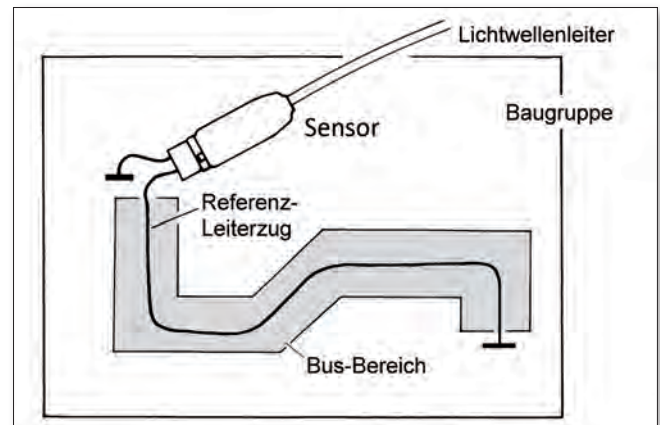
Als besonders kritisch für analoge Systeme erweist sich die HF-Einstrahlung über Antenne bzw. die leitungsgebundene HF Einkopplung. Hierbei werden aus dem elektromagnetischen Feld über die Prüflingsoberfläche bzw. über angeschlossene Kabel hochfrequente elektrische und magnetische Felder in den Prüfling eingekoppelt. Diese Felder erzeugen Störspannungen auf Signalleitungen und im GND - System. Besonders erschwerend wirkt sich die Modulation des HF-Störfeldes aus. Die Norm verlangt, dass die Trägerfrequenz mit 1 kHz 80% amplitudenmoduliert wird. An pn Übergängen wie z.B. in Operationsverstärkern kann die HF demoduliert werden. Als Folge entsteht eine Spannung mit der Frequenz von 1 kHz, die sich dem Nutzsignal überlagert und im analogen Signalweg weitergeleitet wird.

Anforderungen an das Messsystem

Für die Fehlersuche ist es im Allgemeinen ausreichend, das demodulierte 1 kHz- Signal im Prüfling zu messen. Der HF-Träger selbst muß nicht erfasst werden. Dadurch kann ein kleines und kostengünstiges Messsystem angewendet werden. Mit Hilfe eines kleinen Tastkopfes mit AD-Wandler wird das 1 kHz-Fehlersignal in digitale Lichtsignale gewandelt und über LWL rückwirkungsfrei aus dem Prüfling übertragen (Abb. 2).

Das Messsignal im Prüfling ist in der Regel von HF-Spannungen überlagert. Bei der Messung gelangen diese Spannungen an den Tastkopf, das heißt dass der Tastkopf bei Feldstärken bis 200 V/m störfest sein muss.

Messbereich:

Praktisch erforderliche Messbereiche liegen zwischen 5 mV (Audiotechnik und Sensorik) und 50 V (Automatisierungstechnik, ASI-Bus, KFZ – Bordnetz). Wünschenswert



BILD. 5: System zur Übertragung von Signalen mit einem Sensor über Lichtwellenleiter und einen optischen Empfänger zum Oszilloskop.

ist dabei ein hoher Auflösungsbereich (Dynamikumfang). Grenzen geben die Kleinheit, die Übertragungskapazität der seriellen Übertragung und die Stromaufnahme des Tastkopfes vor (Bild 3).

2.3 MESSUNG VON DIGITALEN SIGNALEN

2.3.1 Beeinflussungsmechanismus

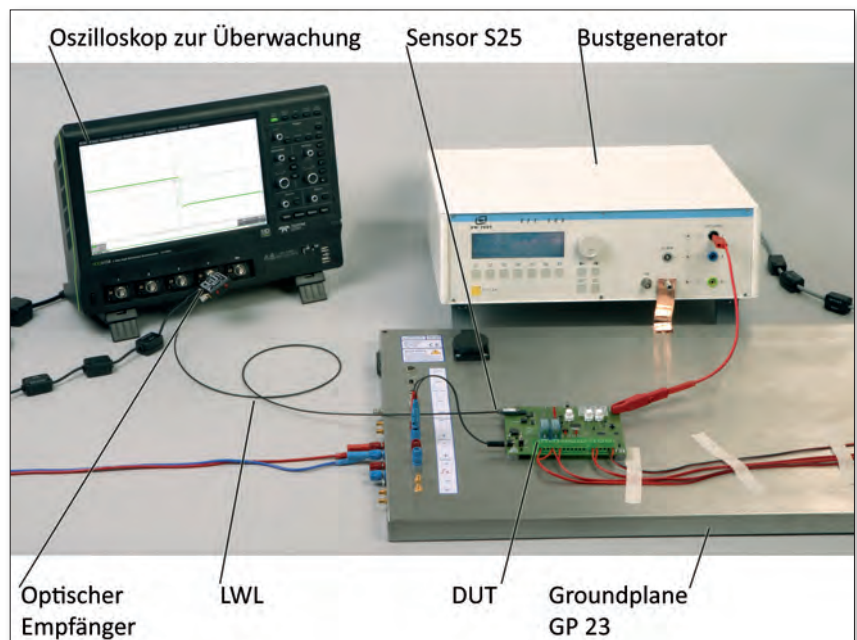
Kurze Störimpulse wie Burst und ESD sind besonders für Digitalschaltungen kritisch. Jeder IC-Eingang bewertet mit seiner dynamischen Eingangsschaltswelle den Störspannungsimpuls an seinem Eingang. Bei Überschreitung seiner Schaltswelle wird dieser Impuls in ein logisches Signal gewandelt und in den Programmablauf eingespeist. Je nach Prüfling werden dadurch ganz bestimmte Funktionsfehler ausgelöst.

Die Störfestigkeit des Prüflings wird wesentlich von der Empfindlichkeit der ICs bestimmt. Die Definition eines Empfindlichkeitsparameters ist wesentliche Voraussetzung für die Beherrschung der Störvorgänge auf der

Baugruppe. Der Empfindlichkeitsparameter ist abhängig von der IC-Technologie (HC, AC, VHC...), vom Shrink und demzufolge vom IC-Hersteller. Der Streubereich der IC-Empfindlichkeit liegt über allen modernen IC-Familien beim Faktor 10. Die daraus resultierenden Schwankungen der Burstfestigkeit können im kV-Bereich liegen.

Im Gegensatz zu digitalen Systemen sind analoge Schaltungen gegenüber Burst und ESD meist robust, da sie diese kurzen Störimpulse nicht erkennen.



BILD. 6: RESET-Überwachung mit Hilfe eines Sensors

2.3.2 Anforderungen an das Messsystem

Es ist kaum möglich, mit vertretbaren Kosten einen Tastkopf zu schaffen, der einerseits hinreichend klein ist, um den Prüfling nicht zu beeinflussen und andererseits bei den gegebenen Feldstärken fehlerfrei die schnellen Störspannungsimpulse über LWL überträgt. Es ist jedoch möglich, einen kleinen Spezialtastkopf (nachfolgend als Sensor bezeichnet) in den Prüfling einzubringen. Dieser Sensor enthält einen digitalen IC bekannter Empfindlichkeit. Erkennt dieser IC mit seiner dynamischen Eingangsschaltswelle einen (Stör-)Spannungsimpuls, gibt er einen definierten Lichtimpuls ab. Damit bildet er die Störschwelle des elektronischen Gerätes nach. Ein Lichtimpuls bedeutet also: Es ist im Prüfling auf der untersuchten Leitung ein Störimpuls aufgetreten, der so groß ist, das er die Gerätefunktion stören kann.

2.4 MESSUNG AUF POTENTIAL

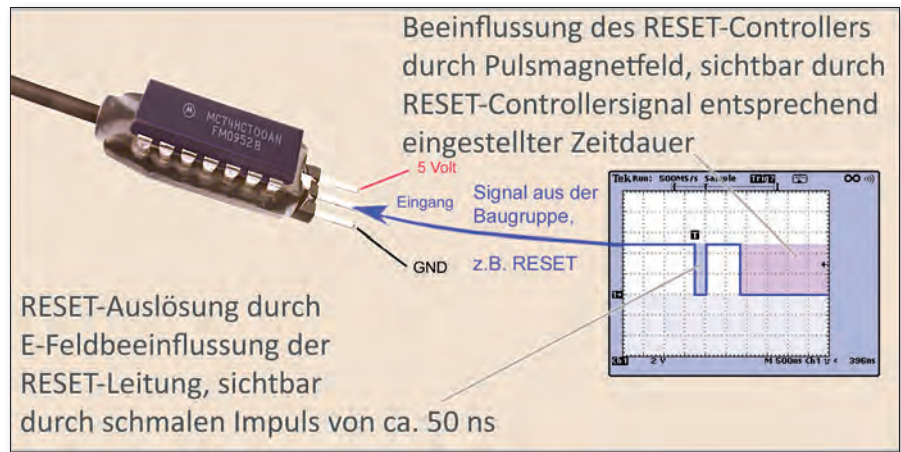
Durch die Signalübertragung über Lichtwellenleiter eignen sich diese Systeme prinzipiell auch für Messungen auf Potential. Lediglich die Spannungsversorgung des Tastkopfes muß potentialfrei z.B. über ein Batteriemodul gestaltet werden.

So werden z.B. Transienten auf der Zwischenkreisspannung von Pulsumrichtern gemessen.

3 MESSSTRATEGIEN

3.1 MESSUNG VON STÖRGRÖSSEN

Es wird mit einem Sensor und einem Leiterzug auf der Baugruppe eine Referenzstörschwelle geschaffen. Der Sensor greift mit dem Leiterzug Spannungsdifferenzen über dem GND-System des Prüflings ab, die durch Störstrom im GND-System verursacht werden (Bild 4).

Bei Überschreitung der Störschwelle des Sensors gibt dieser über einen Lichtwellenleiter ein Lichtsignal ab.

Zur Störfestigkeitsmessung fährt ein Burstgenerator eine Spannungsrampe. Bei Erreichen der Sensorstörschwelle wird die Spannungsrampe durch den Sensor über LWL und optischen Empfänger gestoppt. Der erreichte Spannungswert wird am Generator abgele-

sen und nach Modifikation des Prüflings nachgemessen (Bild 5).

So kann entwicklungsbegleitend die Wirkung von Gegenmaßnahmen schnell bewertet werden. Bei Prüflingen mit Softwarefunktion verkürzen sich die Messzeiten auf einige Sekunden (keine Statistik).

Dieses Verfahren dient hauptsächlich der Dimensionierung von Verbindungssystemen, Schirmungen, Filtern und Ableitwegen. Es kann auch dann angewendet werden, wenn der Prüfling selbst während der Entwicklungsphase noch nicht arbeitet, aber bereits Aussagen über die Gestaltung von Gehäuse und Filtern benötigt werden.

3.2 MESSUNG VON STATISCHEN SIGNALEN

Bei der Fehlersuche ist es zweckmäßig, bestimmte Signale zu überwachen, um Aussagen über den momentanen Zustand des Prüflings zu erhalten. Interessant sind Signale wie INT, RESET oder PFI, die dazu mit einem Sensor über LWL aus dem Prüfling heraus übertragen werden. Ein Zähler (Ereigniszähler) kann die Lichtimpulse aufsummieren und damit als Speicher dienen. So ist fortwährendes konzentriertes Beobachten einer Anzeige nicht mehr notwendig - Modifikationen bei laufender Messung sind ungehindert durchführbar.

Durch Oszillografieren der Signale (über LWL) lassen sich oft Informationen über den Ursprung der Störung ableiten: Im Bild 6 deutet ein kurzer Störimpuls auf der RESET - Leitung eines Prozessors auf eine direkte Beeinflussung dieser Leitung hin, während ein Impuls im Millisekundenbereich durch eine Beeinflussung des RESET - Bausteins hervorgerufen wird.

3.3 MESSUNG VON PERIODISCHEN SIGNALEN

3.3.1 Überwachung des Prüflings

Oftmals ist nicht erkennbar, ob der Prüfling während Störfestigkeitsuntersuchungen noch arbeitet. Beispielsweise ist der Controller schon längst abgestürzt, während das LCD-Display noch die korrekten Daten anzeigt. Die Übertragung charakteristischer Signale aus dem Prüfling



BILD. 7: Demoduliertes 1 kHz-Störsignal am Ausgang eines OPV.

schaft Abhilfe. Signale wie z.B. Chip-Select zeigen an: Der Prozessor arbeitet noch.

3.3.2 Signalüberwachung

Koppeln die Störgrößen z.B. in das Bussystem ein, besteht die Möglichkeit, mittels Oszilloskop Störimpulse nachzuweisen. Gemessen wird mit Hilfe von Sensoren über LWL, die Triggerung kann über die Impulsbreite des gemessenen Signals erfolgen. Die Impulsbreite des Nutzsignals ist meist deutlich größer als die der Störimpulse. Besitzt das Oszilloskop keine solche Triggermöglichkeit oder sind Daten- und Störsignal nahezu gleich lang, kann man auf die Störgröße selbst mit einem Burstdetektor triggern.

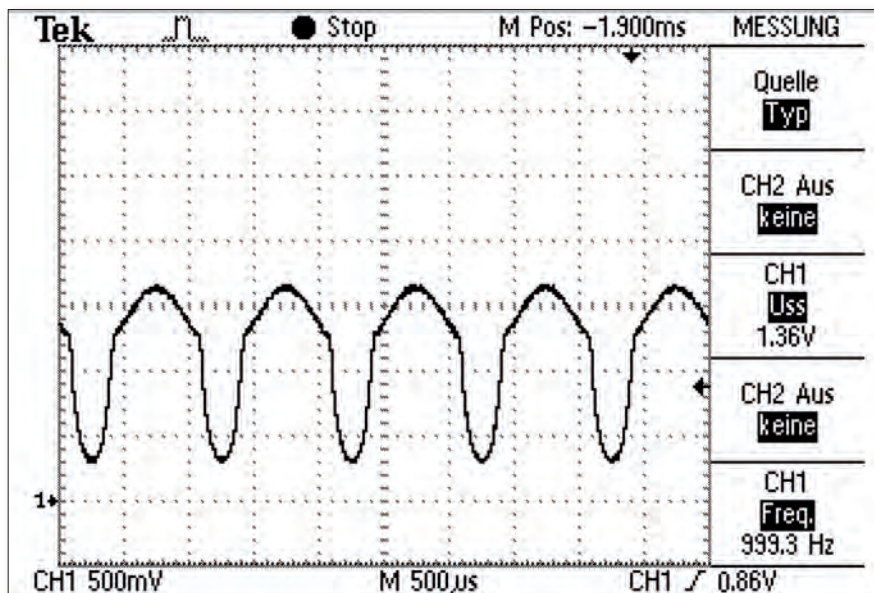
3.4 ANALYSE DES BETRIEBSVERHALTENS

Aufschluß über den Betriebszustand des Prüflings liefern häufig die Daten auf Bussystemen. Dabei erweist sich eine genaue Analyse der Daten mit Oszilloskop oder Logikanalysator als zu aufwendig. Eine schnelle Möglichkeit besteht darin, mit einem Zähler den Datenstrom zu überwachen. Natürlich stellt sich aufgrund der wechselnden Dateninhalte und der fehlenden Synchronisation zwischen Zähler und Datenpaketen nicht immer ein konstanter Zahlenwert am Zähler ein. Meist sind jedoch bestimmten Betriebszuständen bestimmte Zahlenwerte zugeordnet. So erkennt der Entwickler z.B. beim Hochlaufen des Systems nach RESET bestimmte Impulsfolgen und kann daraus auf den jeweils aktuellen Betriebszustand des Prüflings schließen. Während Störfestigkeitsmessungen ist mit diesem einfachen Analysesystem erkennbar, ob z.B. auf Grund von Störbeeinflussung das System neu hochläuft, Daten ungewöhnlich oft neu übertragen werden oder andere Probleme bei der Signalübertragung entstehen.

3.5 ANALOGE SIGNALE

Besonders bei Systemen mit analoger Messwerterfas-

sung und digitaler Verarbeitung ist wichtig nachzuweisen, ob die analoge Größe oder die digitale Verarbeitung gestört wird.

Bild 7 zeigt die Ausgangsspannung eines OPV, in dessen Eingang HF einkoppelt und der das 1 kHz-Signal demoduliert und verstärkt. Diese Demodulation kann an nahezu jedem pn-Übergang auftreten. Für die Störwirkung ist entscheidend, inwieweit durch den Prüfling selbst die demodulierte Störspannung verstärkt wird.

4 ZUSAMMENFASSUNG

Unter Verwendung von LWL-Technik und kleiner störtester Sensoren ist es möglich, während Störfestigkeitsprüfungen Signale im Prüfling fehlerfrei zu messen. Zur

Beurteilung des Prüflingsverhaltens und dem Nachweis von Beeinflussung genügt bei digitalen Systemen oft ein einfacher Zähler. Die Messsysteme sind klein und helfen bei der effizienten Fehlersuche am Arbeitsplatz des Entwicklers. Das einfache Auffinden von Störungsursachen und die direkte Überprüfung von eingebrachten Gegenmaßnahmen ermöglicht ein kontinuierliches Arbeiten am gleichen Messplatz.

HINWEISE AN DIE REDAKTION:

NUTZUNGSRECHT VON FACHARTIKELN DER LANGER EMV-TECHNIK GMBH:

Bei Änderungen am Manuskript bitten wir um Zusendung einer Korrekturfahne vor Abdruck an k.langer@langer-emv.de zur Autorenkorrektur.

Wir machen darauf aufmerksam, dass wir für den Beitrag (Text, Grafiken, Fotos) Ihrer Redaktion, unter Respektierung Ihres Erstveröffentlichungswunsches, das einfache Nutzungsrecht (§ 31 Abs 2 Urheberrechtsgesetz) zur Veröffentlichung und Verbreitung (Print + online, räumlich, zeitlich und inhaltlich unbeschränkt, kein Weiterverkauf, keine Weitergabe) in deutscher Sprache übertragen.

Wenn nichts anderes vereinbart ist, behalten wir uns vor, die Autorenversion oder Teile der Autorenversion auch eigenständig in deutscher Sprache zu veröffentlichen.

Langer EMV-Technik behält sich vor, die Autorenversion des Beitrages, oder gern auch Ihren Beitrag mit Verlinkung, nach einer Wartefrist von 30 Tagen nach dem externen Erscheinungstermin für den Internet-Auftritt der Langer EMV-Technik/Fachartikel zu verwenden.

Der Langer EMV-Technik GmbH bleiben Veröffentlichungen in anderen Sprachen unbeschränkt vorbehalten.

Sofern Sie uns später ein pdf-File oder den Internet-Link zur Verfügung stellen können, sind wir dankbar für Ihren Hinweis.

Wie viel ESD Verträgt ein IC?

Störfestigkeitsprüfung von ICs Unter ESD

SVEN KÖNIG

EMC Engineer
Langer EMV-Technik GmbH

H **EUTZUTAGE WERDEN** an elektronische Geräte besonders hohe Anforderungen an ihre ESD-Festigkeit gestellt. „Nach Schätzungen des TÜV NORD entstehen dem produzierenden Gewerbe durch elektrostatische Entladungen jährlich Kosten in Millionenhöhe. ESD-Effekte führen in Schaltungen zu Ausfällen und diese führen zum Stillstand eines Fahrzeugs, eines Prozesses oder einer Fertigungsstraße“. Eine Elektronik muss unter härtesten Bedingungen zuverlässig und tadellos funktionieren.

Eine Elektronik ist aber bestenfalls so gut, wie die einzelnen eingesetzten Bauteile. Somit müssen diese hohen Anforderungen ebenfalls auch für diese gelten. Besonders im Focus stehen die Integrierten Schaltkreise (ICs). Fast keine Elektronik kommt heute ohne sie aus. Aber welche Tests stehen heute in der Praxis zur Verfügung, um ICs hinsichtlich ihrer ESD-Störfestigkeit zu bewerten und wie sehen diese Tests aus?

Die ESD-Festigkeit von Baugruppen oder Geräten wird häufig durch metallische Gehäuse und aufwändige EMV Maßnahmen (Masselagen, Filter ...) sichergestellt. Diese Methoden sind sehr teuer und erfordern einen hohen Entwicklungsaufwand. Herkömmliche EMV-Maßnahmen kommen erst beim Prototyp oder in einem sehr späten Entwicklungsstadium der Baugruppe/des Gerätes zum Einsatz. Und dann auch nur, wenn sich beim Normgerätetest die ungenügende Störfestigkeit des Gerätes zeigt. Mit diesen Maßnahmen versucht man, die Funktionalität des Gerätes zu sichern. Eine bessere Lösung wäre, von Beginn an die eingesetzten Bauteile, wie zum Beispiel ICs, Steckverbinder,... vor einer Elektronikentwicklung umfangreichen EMV-Untersuchungen und insbesondere einem ESD-Test zu unterziehen. Das ermöglicht dem Entwickler oder Konstrukteur, die Bauteile

This article discusses how much ESD an IC can bear and IC immunity tests under the influence of ESD. Nowadays, electronic devices have to meet the highest standards in terms of ESD immunity. An electronic system must be able to function reliably and without failure even under the severest conditions. But at best an electronic system is only as good as its individual components, which must consequently meet these high demands too. A special point of interest is integrated circuits (ICs), which hardly any of today's electronic systems can do without. This article discusses which tests are available in practice to evaluate ICs in terms of their ESD immunity and how these tests are carried out. To read this article in English, visit our website www.interferencetechnology.com.

¹ TÜV Nord in ELEKTRONIKPRAXIS Nr. 4, 20.02.2014, S 23

² Dipl. Ing. Gunter Langer und Dipl. Ing. Lars Gläßer; Die EMV an einem IC betrachtet – zwei Messmethoden im Vergleich; ELEKTRONIKPRAXIS; 2013

Dipl. Ing. Lars Gläßer; Störungen in Baugruppen besser vermeiden; ELEKTRONIKPRAXIS; 18/2012

hinsichtlich ihrer Robustheit für sein Gerät einzuplanen, was wiederum Zeit spart und Entwicklungskosten senkt.

In der Praxis können in der Regel zwei verschiedene Herangehensweisen an die EMV einer Baugruppe / eines Gerätes verfolgt werden.

In der ersten Herangehensweise wird das Gerät bis zum ersten Muster oder Prototypen entwickelt. In diesem Entwicklungsstadium wird das Gerät einem EMV-Test nach Norm unterzogen, wobei die EMV-Anforderungen an das komplette System definiert werden. Eventuelle Schwachstellen, wie zum Beispiel ungenügend dimensionierte Steckverbinder oder empfindliche ICs werden erst mit diesem Normtest entdeckt und können zu diesem Zeitpunkt meist nicht mehr ohne weiteres geändert werden. Das komplette Gerät oder die Baugruppe kann die definierten EMV-Ziele nicht erreichen und es ist ein umfangreiches Redesign erforderlich, was mit entsprechendem Entwicklungszeitverlust und zusätzlichem EMV-Aufwand verbunden ist.

Bei der zweiten und besseren Herangehensweise wird ein separater EMV-Test der einzelnen ausgesuchten Bauteile schon vor der Entwicklung durchgeführt. Damit werden die EMV-Parameter festgestellt und man kann abschätzen, ob sie für die tatsächlichen EMV-Anforderungen des gesamten Systems passend sind. Somit können schon zur Entwicklungsplanung gezielt Bauteile ausgesucht und für eine robuste Elektronik eingesetzt werden.

Hinsichtlich der EMV-Störfestigkeit von Baugruppen und Geräten fallen besonders die ICs ins Gewicht. Sie werden mit immer kleineren Strukturbreiten gefertigt, tackten immer schneller und ihre Versorgungsspannungen und die damit verbundenen Schaltschwellen werden aus Gründen der Energieeffizienz immer weiter abgesenkt. Dadurch sind die ICs oft die Schwachstellen im gesamten System und es ist bei ihnen besonders wichtig, dass sie definierten EMV-Anforderungen standhalten. Gerade deshalb müssen EMV-Tests an ICs durchgeführt werden, um die Funktionsfähigkeit des gesamten Systems zu gewährleisten.

Die Testverfahren für ICs müssen sich an den Normtestverfahren für Geräte orientieren. Man kann aber die herkömmlichen Normtests nicht direkt auf ICs anwenden, da während dem Normtest auf der Baugruppe nicht die in der Norm fest geschriebenen Störgrößen am IC wirksam werden. Die von außen mit einem Störgenerator in das Gerät eingekoppelte Normstörgröße beaufschlagt den IC und seine Leitungsnetze durch magnetische und elektrische Felder. Durch diesen Effekt, die magnetische und elektrische Koppelung, sind die Störgrößen am IC hinsichtlich Verlauf, Amplitude und Wirkungsweise anders, als die Normstörgrößen. Deshalb müssen IC-Testverfahren als gesonderte Testverfahren neu definiert werden.

Des Weiteren entstehen neben dem gewünschten Normimpuls parasitäre Felder direkt vom Generator, die ebenfalls das Gerät oder dessen Teile beeinflussen können. Diese unerwünschten elektrischen und magnetischen Felder sind im Wesentlichen vom Typ und von der Position des ESD-Generators abhängig. Aus diesem Grund können sehr große Ungenauigkeiten bei den Gerätetests entstehen. Auch ein direkter ESD-Test einzelner IC-Pins, wie es teilweise bei IC-Herstellern durchgeführt wird, ist somit nicht reproduzierbar und ungenau.

Deshalb müssen die Störungen am Schaltkreis auf Grund-



ABB. 1: Koppelmechanismus des magnetischen Feldes.

lage der magnetischen und elektrischen Kopplungen definiert werden. Bei der magnetischen Beeinflussung erzeugt der Störstrom im Gerät ein entsprechendes magnetisches Feld. Es kann in vorhandenen Schleifen (z.B. Leitungsnetzen) eine Störspannung induziert werden. Dieser Störpuls fällt an den hochohmigen IC-Eingängen ab und beeinflusst diesen. Weiterhin kann die Störung andere Bereiche im IC (PLL, Core...) beeinflussen. Kritische Leitungen für die Magnetfeldbeeinflussungen sind z.B. das Versorgungssystem, niederimpedante Signale sowie Leitungen die kapazitiv mit Ground oder Vcc verbunden sind.

Die Wirkung der magnetischen Kopplung ist vergleichbar mit einem Transformator (Abb. 1). Werden niederohmische Vdd-Schleifen des ICs beeinflusst, kommt es zu einem induktiven Stromteiler. Der vom Störgenerator erzeugte Störstrom wird auf die Leitungsnetze des ICs übertragen. Bei der Beeinflussung von niederohmig beschalteten IC-Eingängen, kommt es bei der Störbeeinflussung über das Magnetfeld zur Differenzierung des Störpulses. Die induzierten Spannungen sind viel schneller und kürzer als die eigentliche Störgröße des ESD Generators. Heutige Schaltkreise sind schnell genug, um diese differenzierten Störgrößen (<1ns) auszuwerten und dadurch beeinflusst zu werden.

Bei der elektrischen Störbeeinflussung sind hauptsächlich Leitungen mit einer hohen Impedanz empfindlich. Die Spannungsdifferenz zwischen der Schaltung und der Umgebung (Metallteile, ESD Generator...) erzeugt ein elektrisches Feld, welches die Signale oder den Schaltkreis beaufschlagen kann.

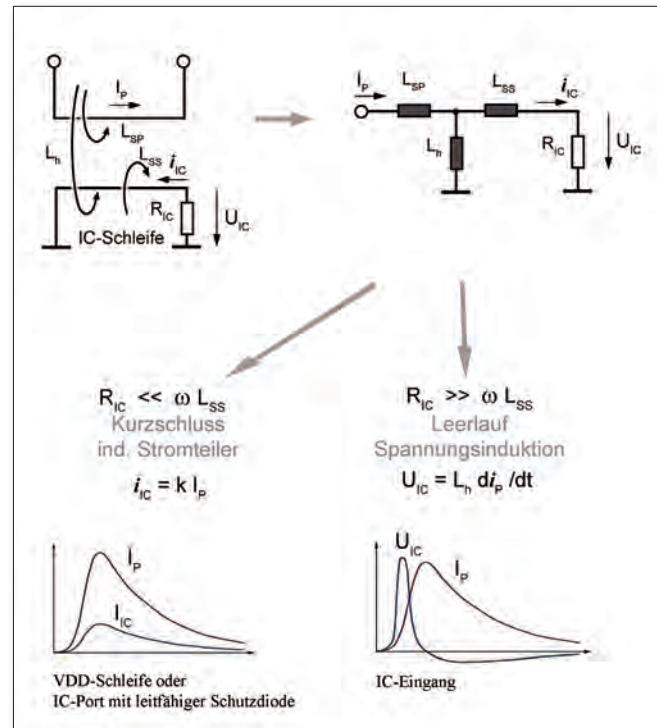
³ Dipl. Ing. Gunter Langer und Dipl. Ing. Griebach Integrierte Schaltkreise (IC) sind heute die EMV-Schwachstellen elektronischer Geräte.; ELEKTRONIKPRAXIS; 05/2014 online

⁴ Dipl. Ing. Gunter Langer, „Die Störwirkung der ESD-Pistole“ in 3 Teilen, ELEKTRONIKPRAXIS, 21+24/2012 & 05/2013



ABB. 2: Koppelmechanismus des elektrischen Feldes.



ABB. 3: Magnetische Einkopplung, Nachbildung mit einer sehr nieder-impedanten Quelle ($R \ll 50 \text{ Ohm}$).

Der entstehende Spannungspuls auf den Leitungen führt je nach Empfindlichkeit des ICs zu einer Beeinflussung. Kritische Pins oder Leitungen sind zum Beispiel Reset, Clock, Quarz, Testpins oder hochohmige Messeingänge z.B. von A/D-Wandlern.

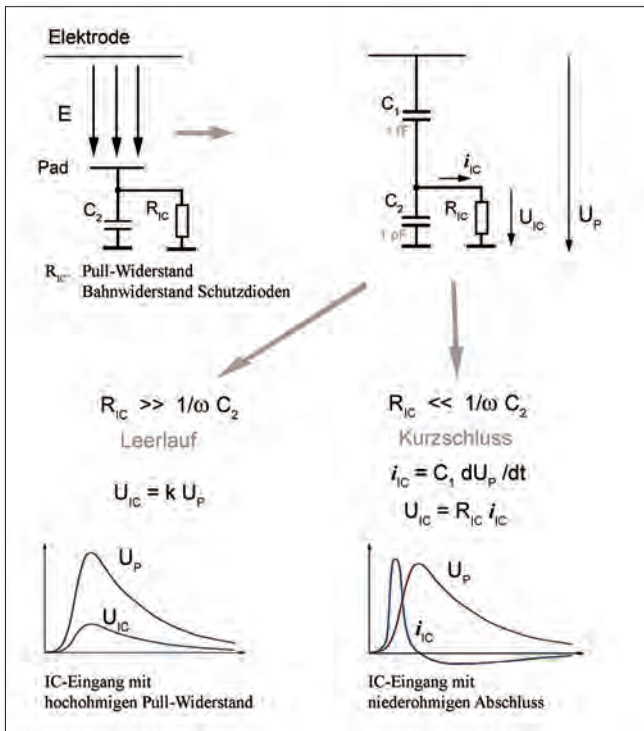
Bei dem Koppelmechanismus des elektrischen Feldes (Abb. 2) ist die Kapazität zwischen Umgebung und den Leitungsnetzen des Schaltkreises die entscheidende Größe. Bei der kapazitiven Beeinflussung eines niederohmig beschalteten IC-Eingangs kommt es ebenfalls zur Differenzierung der Störgröße. Bei hochohmig angeschlossenen Leitungen wird der Störspannungspuls direkt über den kapazitiven Spannungsteiler übertragen. Die Auswirkungen auf den IC sind letztlich ähnlich, wie bei der magnetischen Kopplung.

Heutzutage werden ICs vom Hersteller in der Regel auf die Zerstörfestigkeit getestet. Diese Tests (z.B. HBM; MM; HMM) sichern nur die Zerstörfestigkeit des ICs zum Beispiel bei der Produktion. Das hat nichts damit zu tun, wie der IC in seiner jeweiligen Anwendung beeinflusst werden kann. Um sicher zu stellen, dass der IC in seiner Anwendung störungsfrei funktioniert, werden heute Tests in Anlehnung an die Normtests von Burst und ESD durchgeführt. Bei der Transient Injection Method (IEC-62250-3) werden die IC Pins direkt mit Störpulsen aus dem Norm-Burstgenerator beaufschlagt. Dieser Generator hat keinen angepassten Leitungsabschluss und der Messaufbau ist elektrisch lang, was zu undefinierten Störungen führt. Die Bewertung der Störfestigkeit des ICs geschieht durch die Leerlaufspannung am Generator und nicht durch den Störstrom bzw. Störspannung direkt am IC-Pin. Der Nachteil ist, dass man damit keine

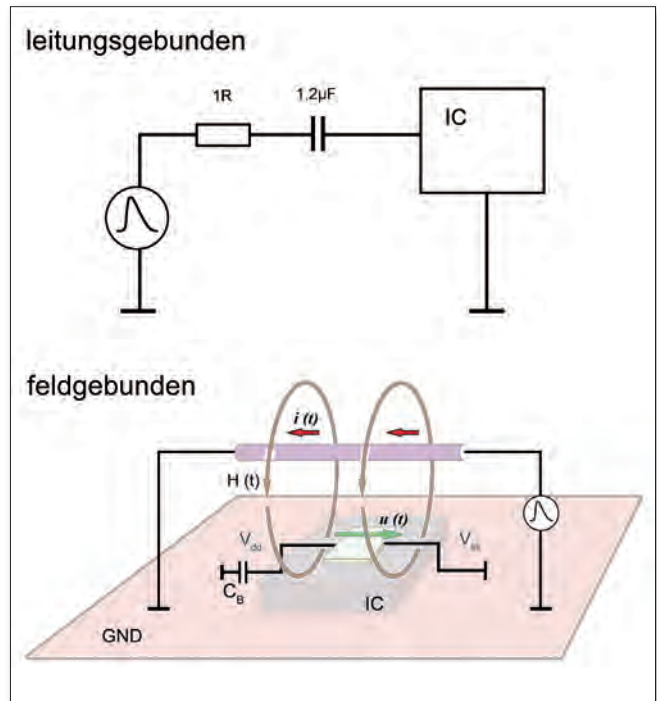
Rückschlüsse auf die Empfindlichkeit des ICs auf elektrische oder magnetische Felder schließen kann. Bei der direkten Beaufschlagung mit ESD (Powered ESD Susceptibility Test oder HMM) wird der IC-Pin direkt mit dem ESD-Störpuls beaufschlagt. Diese Störgröße, wird in der Praxis so am IC nicht auftreten. Des Weiteren entstehen am ESD Generator unerwünschte elektrische und magnetische Störfelder, welche ebenfalls auf den zu testenden IC einwirken und damit die Tests nur schwer oder gar nicht reproduzierbar machen.

Sinnvolle Testverfahren müssen die physikalischen Wirkprinzipien im Gerät nachbilden. Um eine magnetische Einkopplung in den IC-Pin nachzubilden, benötigt man eine sehr niederimpedante Quelle ($R \ll 50 \text{ Ohm}$). Damit kann man eine Störgröße erzeugen, die in der IC-Anwendung durch Spannungsinduktion im IC oder an den Leitungsnetzen auftreten (Abb. 3). Zur Nachbildung der elektrischen Einkopplung wird ein sehr hochimpedanter Störgenerator benötigt ($R \gg 50 \text{ Ohm}$). In Verbindung mit einer sehr kleinen Koppelkapazität kann man damit die elektrische Beeinflussung nachbilden. (Abb. 4)

Mit dem IC-Testsystem kann man die verschiedenen Testverfahren an den Schaltkreisen rückwirkungsfrei und reproduzierbar durchführen.

Der IC wird auf eine Testleiterkarte (Testboard) aufgebracht und mit allen notwendigen bzw. gewünschten Signalen und der Stromversorgung verbunden. Dieses Testboard ermöglicht einen EMV-gerechten Anschluss des Prüflings und enthält alle benötigten Filterelemente um eine Entkopplung zwischen IC und Umgebung sicher zu stellen. Das Testboard ist mit dem ConnectionBoard verbunden. Das Connection Board ist eine Einheit zur Steuerung und zum Monitoring des Prüflings (IC). Das Testboard und das Connection Board befinden sich in der Groundplane. Die Groundplane dient als Bezugsmasse für die Tests. Damit

⁵ ELEKTRONIKPRAXIS, 21+24/2012 & 05/2013, „Die Störwirkung der ESD-Pistole“ in 3 Teilen, Autor: Dipl. Ing. Gunter Langer



ABB. 3: Magnetische Einkopplung, Nachbildung mit einer sehr nieder-impedanten Quelle ($R \ll 50 \text{ Ohm}$).

wird ein HF-gerechter Anschluss des Prüflings und mit den entsprechenden Test-Systemen (Probes) und ein kleinräumiger Messaufbau gewährleistet. Mit den Probes können sowohl Störaussendungsmessungen als auch Störfestigkeitstests durchgeführt werden. (Abb. 5). Sie werden auf der Groundplane aufgesetzt und sind mit dieser niederimpedant verbunden. Mit einer Probe kann man flexibel und direkt an beliebigen Pins kontaktieren. Das komplette Messsystem befindet sich in der Probe und muss nicht mehr im Layout des Testboards integriert werden.

Für die Nachbildung der im ersten Abschnitt genannten ESD-Wirkprinzipien stehen die Probes der Serie P200 und P300 zur Verfügung. Die Probes P200 haben einen sehr niederimpedanten Pulsgenerator integriert, um die Effekte der magnetischen Störbeeinflussung nachzubilden, die während ESD-Einwirkung in einer Anwendung auf den IC einwirken. Die Beeinflussungsmechanismen durch elektrisches Feld werden mit der Probe P300 nachgebildet. Diese ist hochohmig und besitzt eine sehr kleine Koppelkapazität. Mit dem Testsystem hat der Entwickler die Möglichkeit einen einzelnen Pin zu kontaktieren und bei Bedarf über einen automatischen Prüfablauf die unterschiedlichen Störschwellen für elektrische oder magnetische Beeinflussung eines Pins zu bestimmen. Neben den leitungsgeführten IC-Testmethoden steht auch eine Vielzahl feldgebundener Messsysteme (HF, ESD, Burst) zur Verfügung.

Für den Anwender ergeben sich mit dem IC-Testsystem folgende Vorteile:

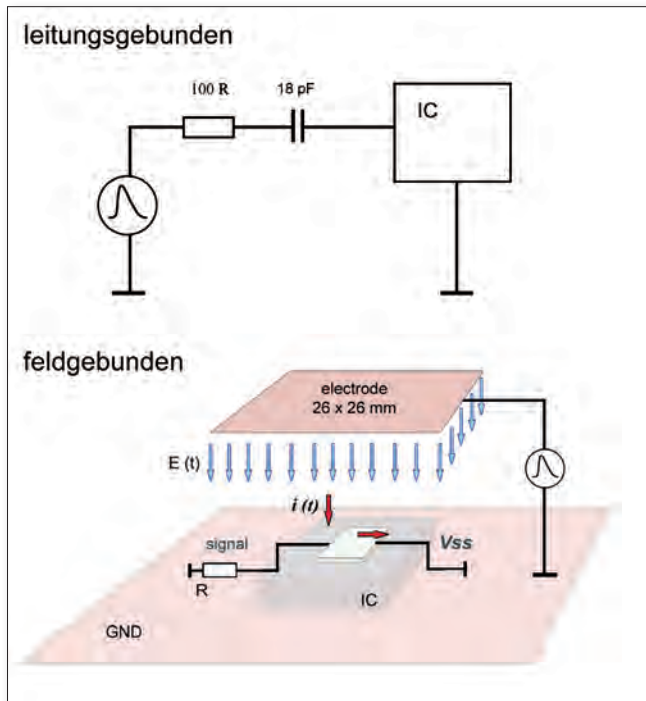
- EMV-Parameter einzelner Bauteile können direkt miteinander verglichen werden
- Bauteile können zielgerichtet für Layouts ausgewählt werden



ABB. 5: Messaufbau mit Probe 201 zur Messung der magnetischen Einkopplung.

- Verhalten von Bauteilen hinsichtlich ihrer Störfestigkeit sind voraussagbar

Gleicherweise kann auch der IC-Hersteller Vorteile aus Tests seiner Schaltkreise mit dem IC-Testsystem ziehen:

- EMV-Parameter bestehender ICs können überprüft werden
- Störursachen können aufgeklärt werden
- Optimierungsprozesse von ICs können mit Anwendung des IC-Testsystems effizient und zielführend durchgeführt werden.

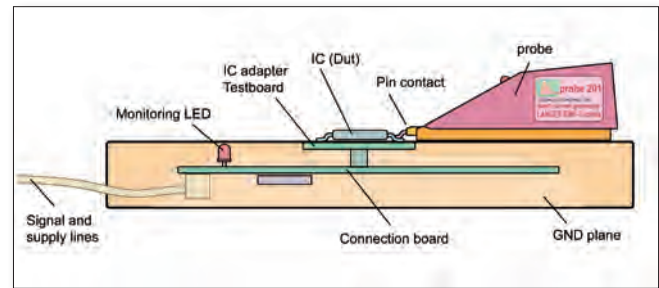
Das IC-Testsystem ist ein System für alle IC-Messungen/ Tests (Normmessungen sowie entwicklungsbegleitend), mit dem alle relevanten EMV-Parameter von ICs bestimmt werden können.

WEITERFÜHRENDE LITERATUR:

- Dipl. Ing. Gunter Langer und Dipl. Ing. Lars Gläßer; Die EMV an einem IC betrachtet – zwei Messmethoden im Vergleich; ELEKTRONIKPRAXIS; 2013
- Dipl. Ing. Lars Gläßer; Störungen in Baugruppen besser vermeiden; ELEKTRONIKPRAXIS; 18/2012
- Dipl. Ing. Gunter Langer und Dipl. Ing. Griefßbach; Integrierte Schaltkreise (IC) sind heute die EMV-Schwachstellen elektronischer Geräte. ; ELEKTRONIKPRAXIS; 05/2014 online
- Dipl. Ing. Gunter Langer, „Die Störwirkung der ESD-Pistole“ in 3 Teilen, ELEKTRONIKPRAXIS, 21+24/2012 & 05/2013, „Die Störwirkung der ESD-Pistole“ in 3 Teilen, Autor: Dipl. Ing. Gunter Langer
- Dipl.-Ing. Gunter Langer, „Pin-and-Socket Connector Coupling Inductivity“, August 2007, Paper from the firm of Langer EMV-Technik GmbH, mail@langer-emv.de
- Dipl.-Ing. Gunter Langer, „instructions-EMC requirements and test methods to test the pulse immunity of ICs and ASICs“, July 2014, Paper from the firm of Langer EMV-Technik GmbH, mail@langer-emv.de

BIOGRAFIE

Dipl.-Ing. (BA) Sven König arbeitet seit 2007 als Entwicklungsingenieur bei der Langer-EMV Technik GmbH. Er absolvierte sein Studium der Elektrotechnik an der Studienakademie in Bautzen. Seine Tätigkeitsschwerpunkte sind die Kundenbetreuung und die Entstörung von Baugruppen. Des Weiteren vermittelt er seine erworbenen Kenntnisse in EMV-Seminaren.

FRANCE

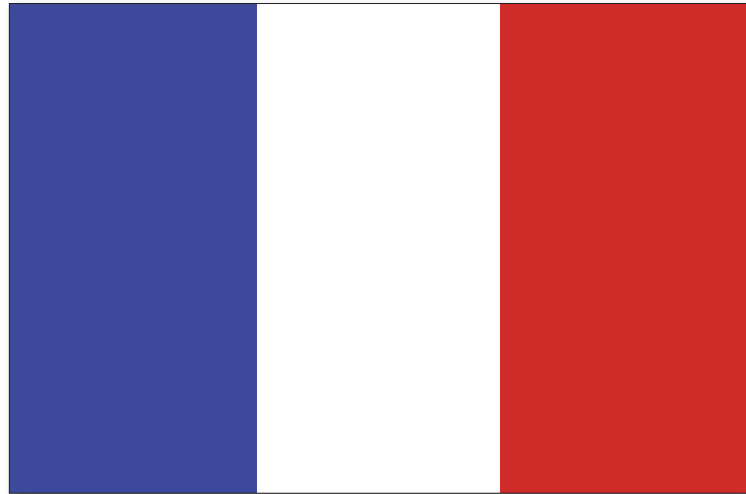

72 **PRODUITS ET SERVICES**

76 **RESSOURCES**

78 **ARTICLES**

Nouvelles Exigences et Méthodes de Tests de L'ue Pour L'Équipement de Transmission de Données ISM 2,4 GHz

DAVID ZHANG, NIMA MOLAEI, LESLIE BAI, SIEMIC Laboratories

Alternatives "Etat Solide" Aux Amplificateurs à Tubes à Ondes Progressives Maintenant des puissances jusqu'à 3000W



3000S1G2z5
3000 Watts
1.0-2.5 GHz

La nouvelle Série « S » 1-2.5 GHz d'Amplificateurs à Etat Solide de AR

Il y a plusieurs choses importantes à considérer lors du choix d'un amplificateur, comme les harmoniques, la linéarité, la durée de vie, la puissance, la fiabilité et bien sûr le coût d'exploitation total.

Trop souvent, vous devez vous orienter vers un ATOP de design ancien pour obtenir la puissance dans un format raisonnable, mais vous pouvez maintenant choisir un matériel accessible à la pointe de l'état de l'art et conforme à vos besoins stricts.

Avec les amplificateurs AR de la nouvelle Série « S » dans la bande 1-2.5GHz, existant en 100, 250, 500, 1000, 2000 et 3000W, vous bénéficiez de la fiabilité et des performances avantageuses de l'état solide sans besoin de se préoccuper du comportement d'un ATOP de design ancien.

C'est parce qu'ils sont fabriqués par AR, qu'ils bénéficient du support du réseau de maintenance international d'AR. Pourquoi donc, choisir un amplificateur quelconque alors que vous pouvez accéder à tous les bénéfices que vous avez toujours souhaités ? www.ar-europe.ie/1-2.5GHz

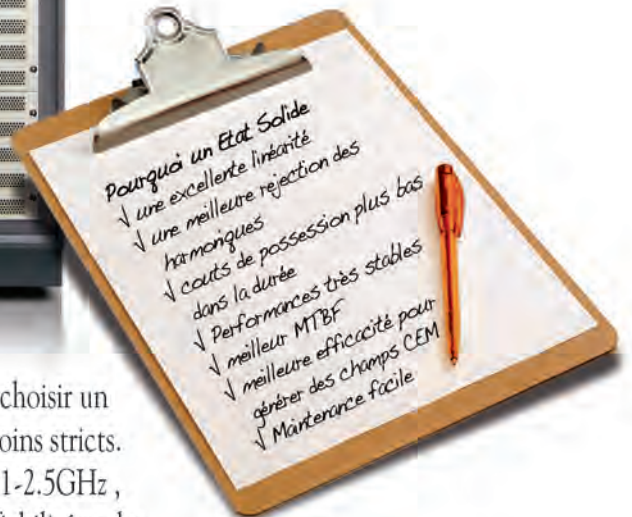

contact@arfrance.eu

+33 147 917530

ISO 9001:2008
Certified

ar europe

National Technology Park, Ashling Building, Limerick, Ireland • +353 61 504300 • www.ar-europe.ie

In Europe, call ar United Kingdom +44 1908 282766 • ar France +33147917530 • ar Deutschland +49 6101 80270 0 • ar Benelux +31 172 423000

www.arworld.us

Copyright © 2014 AR. The orange stripe on AR products is Reg. U.S. Pat. & TM. Off.



PRODUITS ET SERVICES

A

A.H. SYSTEMS



A.H. Systems Inc.
AR France, 7 Rue des Fosses Blanc Bat D1,
F-92230, Gennevilliers, France

+(0)11 33 1 47 91 75 30; Fax: +(0)11 33 1 47 91 75 35
contact@arfrance.eu; www.AHSystems.com
Produits et services: Antennes, Instrument de contrôle, Contrôles

AA Opto-Electronic

AA MCS, 18, rue Nicolas Appert, F-91898, Orsay Cedex, France
+33 01 76 91 5012 Fax +33 01 76 91 5031
sales@aa-mcs.com; www.aa-mcs.com
Produits et services: Micro-ondes, amplificateurs de puissance, coupleurs à large bande, diviseurs, filtres



Aaronia AG

Kauthenbergstr. 14, Strickscheid, DE-54597 Germany;
Fax:+49(0)6556-93034; +49(0)6556-93033;
Vanessa Bauer, VB@aaronia.de
Thorsten Chmielus, owner, TC@aaronia.de
Manuel Pinten, Materials contact, mp@aaronia.de
www.aaronia.de
Produits et services: Antennes, Protection, Instrument de contrôle

A.H. Systems, inc.



Represented by

AR France

TEL: 33 1 47 91 75 30
FAX: 33 1 47 91 75 35
<http://www.arfrance.eu/>
contact@arfrance.eu

France



A.H. Systems
<http://www.AHSystems.com>

Apache Design Solutions

La Grande Arche, Paroi Nord, Paris La Defense, 92044, France
+33(0)1 43 25 92 45 Fax: +33(0)1 40 84 57 21 41;
Jose Gandlarz; jose@apache-da.com;
www.apache-da.com
Produits et Services: Miscellaneous



AR France

7 rue du Fosse Blanc, Bat D1, Gennevilliers, France 92230
+33(0)1 47 91 75 30; Fax: +33(0)1 47 91 75 35
Bernard Bessot; contact@arfrance.eu; www.arfrance.eu
Produits et services: Amplificateurs, Antennes, Câbles et connexions, Espaces sous protection et clôtures, Hausse et éléments temporaires, Instrument de contrôle

Arrow Europe

13-15 rue de pont des Halles Rungis 94656
+33(0)1 4978 4949
www.arroweurope.com
Produits et services: Ferrites, câbles et connecteurs, applications de puissance

C

Carlisle Interconnect Technologies

United Kingdom
+44-7817-731-000
Andy Bowne, Andy.Bowne@carlisleit.com
www.CarlisleIT.com
Produits et services: Filtres

EMC Partner

Rosiers d'Egletons, France
+33 5 55 74 31 68; ppoiiret@emc-partner.fr
www.comtest.eu
Produits et services: Chambres anéchoïques, salles

de réverbération, RF chambres et portes blindées, les absorbeurs d'ondes

CST France Eurl

ACMO Parc, 10 Avenue Réaumur, 92140 Clamart France
+33 1 45 37 38 25; Fax: +33 1 45 37 01 43
info@france.cst.com; www.cst.com

Produits et services: Essais, antennes, blindage, câble, logiciel, bouchons

E



EM Test France

EM TEST France, Le Trident - Parc des Collines, 36, Rue Paul Cézanne, 68200 Mulhouse, France; +33 3 89 31 23 50; Fax: +33 3 89 31 23 55; info@emtest.fr; www.emtest.fr

Produits et services: Innovative test- and measurement systems für conducted immunity tests, ESD, transients, automotive, harmonics & flicker, AC/DC-sources, safetytest systems, accredited calibrations, seminars, workshops, consulting

EMC Partner France

Mr Pascal POIRET, 6 rue Clément VI 19300 Rosiers d'Egletons - France
+33 (0)5 55 74 31 68; Fax: +33 (0)5 55 87 47 69
contact@emc-partner.fr; www.emc-partner.fr
Produits et services: Générateurs et solutions CEM & RF

EMI TECH

3, rue des Coudriers - CAP 78, ZA de l'Observatoire, 78180 Montigny le Bretonneux France
+33(0)1 30 57 55 55; Fax: +33(0)1 30 57 8640
Jean Luc Tisserand, jl.tisserand@emitech.fr
www.emitech.fr
Produits et services: Contrôles

Eurofarad

93, rue Oberkampf, F-75540 PARIS Cedex 11, France;
+33(0)1 49 23 10 00; Fax: +33(0)1 43 57 05 33
info@eurofarad.com; www.eurofarad.com
Produits et services: Filtrés

EuroMC

12/24 Avenue de Stalingrad Stains, ZA St, Leger, 93240, France
+33 1 58 34 00 00; Fax: +33 1 58 34 07 07
EuroMC@wanadoo.fr; www.euromc.fr
Produits et services: Filtrés, Protection, Espaces sous protection et clôtures



ETS-Lindgren

Z.A. Saint Léger - Batiment; 12-24 Avenue Stalingrad, 93240 Stains
+33 1 49 40 19 30; Fax: +33 1 49 40 19 31
france@ets-lindgren.com; www.ets-lindgren.com
Produits et services: Antennes, ferrites, filtres, chambres blindées et boîtiers, Générateurs de signaux RFI / EMI, instrumentation de test, Divers

F



Fair-Rite Products

Schaffner EMC SAS, 112, Quai de Bezons B.P. 133 95103 Argenteuil France
+33(0)1 34 34 30 60; Fax: +33(0)1 39 47 02 28
francesales@schaffner.com; www.fair-rite.com
Produits et services: Ferrite, Filtrés, Espaces sous protection et clôtures, Protection

FCI Connectors

Immeuble Calypso, 18 Parc Ariane III, 3-5 rue Alfred Kastler, 78 280 Guyancourt, France
+33 1 72 67 35 00; Fax: +33 1 72 67 36 83
france@fci.com; www.fciconnect.com
Produits et services: Câbles et connexions

Federal-Mogul Corporation

69, rue Henri Laroche, 60800 Crépy-en-Valois
+33 3 44 39 06 06; Fax: +33 3 44 94 48 33
systems.protection@federalmogul.com
www.federalmogul.com/sp
Produits et services: Ensembles de câbles blindés & harnais conduits, tuyaux blindés blindé

EMC GLOBAL SOLUTIONS



EMI RECEIVERS & ANALYZERS
RF IMMUNITY SYSTEMS
FIELD PROBES
ANCILLARIES



Narda Safety Test Solutions srl

Via Leonardo da Vinci, 21/23, 20090 Segrate (MI) ITALY
Phone: +39 02 26 998 71 - Fax: +39 02 26 998 700
E-Mail: nardait.support@L-3com.com - Website: www.narda-sts.it

G

GETELEC

375 rue Morane Saulnier, 78530 Buc- France
 +33(0)1 39 20 42 42; Fax: +33(0)1 39 20 43 43
 info@getelec.com; www.getelec.com
Produits et services: Matériaux conducteurs, Protection

Gowanda Electronics

ACAL BFI; ZI De La Petite Montagne Sud, 4 Allée Du
 Cantal, CE 1834 Lisses, Evry Cedex, France, 91018
 +33 01 60 79 59 00; 33 01 60 79 89 01
 info@bfiptilas.com; www.bfiptilas.com
Produits et services: Inducteurs

I



RF/Microwave Amplifiers

IFI - Instruments for Industry

AMETEK SAS, TESEQ, 50, Rond Point de l'Épine des
 Champs , Buroplus, Bât D; 78990 Elancourt; + 33 (0)1
 30 68 89 56; +33 (0)1 30 68 89 99 francesales@teseq.
 com; www.ametek-cts.com
Produits et services: High Power Microwave and RF
 Amplifiers (Tetrode Tubes, Solid State and TWT) up
 to 40 GHz

K



Kemtron SARL

9, Avenue du Bois de l'Épine, Z.A. du bois de l'épine
 91080 Courcouronnes, France
 01.60.77.83.16; Fax : 09.72.38.81.33
 Pascal Malblanc, info@kemtron.fr; www.kemtron.fr
Produits et services: Matériaux conducteurs, Protec-
 tion CEM

L

Langer EMV-Technik GmbH

M2S SARL, 3 rue des Martins Pêcheurs, F-66700
 Argelès sur Mer France
 04-68-81-49-52; Fax: 04-68-81-62-16
 m2s@wanadoo.fr; www.langer-emv.de
Produits et services: Instrument de contrôle

M



RF/Microwave Amplifiers

MILMEGA

AMETEK SAS, TESEQ, 50, Rond Point de l'Épine des

Champs , Buroplus, Bât D; 78990 Elancourt; + 33 (0)1
 30 68 89 56; +33 (0)1 30 68 89 99 francesales@teseq.
 com; www.ametek-cts.com
Produits et services: High Power RF and Microwave solid
 state amplifiers. Frequency range 80MHz up to 6GHz,
 with output powers to 1kW

M2S

3 Rues Des Martins Pêcheurs, 66700
 Argeles Sur Mer, France; +04 68 81 49 52;
 contact@m2s-argeles.fr; www.m2s-argeles.fr
Produits et services: EMC test; distributeur d' CPI,
 ETS Lindgren, Langer, Solar Electronics; Service
 d'étalonnage par un laboratoire accrédité

N



**Narda Safety Test Solutions S.r.l.
 EM TEST S.A.**

Le Trident - Parc des Collines, Immeuble B 1 – Etage 3
 36, rue Paul Cézanne, 68200 MULHOUSE
 Tel: +33 3 89 31 23 50, Fax: +33 3 89 31 23 55
 Web: http://www.emtest-france.com
 email info@emtest.fr
Produits et services: Tests de RF, étalonnage, EMC, de
 la sécurité



Nexio

46 Avenue du General de Crouette, Toulouse, 31100 France
 +33(0)5 61 44 02 47; Fax: +33(0)5 61 44 05 67

FEBRUARY 18, 2015



NOVEMBER 12, 2015



**LEARN HOW TO DESIGN & TEST FOR EMC
 ~ FOR FREE ~
 FROM THE COMFORT OF YOUR OWN CHAIR
 emclive2015.com**

Spectrum Analyzer



1Hz - 9.4GHz



Handheld Spectrum Analyzer

- Based on a patented spectrum analyzer method
- Very high sensitivity and low sample time
- WORLDRECORD: -170dBm DANL (1Hz)
- Integrated 3D (isotropic) magnetic sensor
- RF exposure limit calculation
- Real-time remote control via USB
- Internal Data Logger for continuous storage of measurement results
- LogPer Antenna and Analyzer-Software included in delivery
- Warranty: 10 years

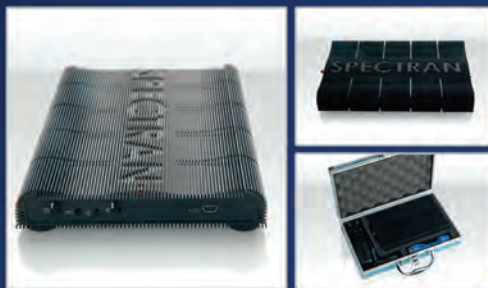

USB Spectrum Analyzer

- Wide frequency range starting from 1Hz up to 9,4GHz (EMF & RF)
- Based on a patented spectrum analyzer method
- Different EMF and RF versions available
- Powerful desktop measurement solution
- Very high sensitivity and low sample time
- Real-time remote control via USB
- Very thick (3mm) aluminum housing offers very good screening
- Pro Analyzer Software included in delivery
- Warranty: 10 years



Remote Spectrum Analyser (19")

- Full remote control from any location with any device
- Continuously streaming and storing from any spectrum of interest
- Allows the monitoring of multiple sites from one centralized location
- Integrated Celeron or i5 PC and huge HDD for continuous data logging
- 19" standard module with one height unit only (1U)
- PC/MAC/LINUX Analyzer Software included
- Extremely high Sensitivity (max. -170dBm/Hz)
- Wide frequency range starting from 1Hz up to 9,4GHz (EMF & RF)
- Customizable Alarm-, Trigger- and Limits-Function

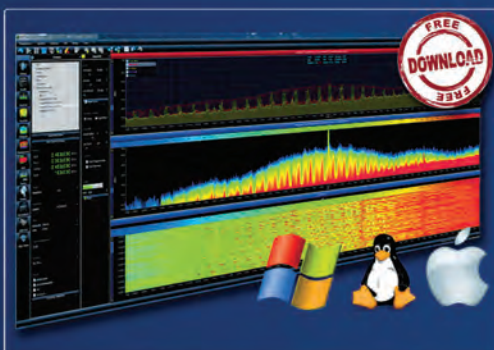

Analyzer-Software included with all
Analyzers for **FREE!**

MADE IN GERMANY

AARONIA AG
WWW.AARONIA.DE

Frederic Amoros, President; frederic.amoros-routie@nexio.fr; www.nexio-online.com
Produits et services: Instrument de contrôle, Divers

P

Prana

Z.I. La Marquisie, Avenue du 4 Juillet 1776, Brive Cedex 19101 France
 +33(0)5 55 86 49 33; Fax: +33(0)5 55 86 49 45
 Dennis Dumont, ddumont@prana-rd.com
 www.prana-rd.com
Produits et services: Amplificateurs

R



Rohde & Schwarz France

9 – 11, rue Jeanne Braconnier, 92366 Meudon-la-Forêt Cedex, France
 +33 (0) 6 89 09 29 65; Fax: +33 (0) 1 41 36-1111
 Vincent Lascoste, Vincent.Lascoste@rohde-schwarz.com; www.rohde-schwarz.fr
Produits et Services: EMC Test Equipment et Accessoires, amplificateurs à large bande, logiciel de mesure de CEM, clé en main de tester des solutions de système

S



Schlegel Electronic Materials

Yelloz Component - MILMEGA, 4 Rue de Mayotte Z.I. de Courtaboeuf, FR- 91940 Les Ulis, France
 +33(0)1 64 46 04 42; Fax: +33(0)1 64 46 92 70
 Eric Stunault; estunault@yellozgroup.com
 www.yellozgroup.com
Produits et services: Matériaux conducteurs, Protection

Schurter S.A.S.

Route de Châteauevillain, 52210 Arc en Barrios, France
 +33 3 2502 5049
 contact@schurter.fr; www.schurter.fr
Produits et services: Filtrés, Protection

T

TDK Electronics France

41 rue Delizy, F-93500 Pantin, France
 +33-(0)1-49466789
 info@tdkrf.com; www.tdkrfolutions.com
Produits et services: Antennes, filtres, logiciels, services de test

Tech-Etch, Inc.

Yelloz Components
 Za de Courtaboeuf, 4 Rue de Mayotte, F-91940 Les Ulis, France
 +33 164 46968; Fax: +33 160 923801
 yellozcomponents@yellowzgroup.com;
 www.tech-etch.com
Produits et services: Matériaux conducteurs, Protection



Advanced Test Solutions for EMC

Teseq Sarl

AMETEK SAS, TESEQ, 50, Rond Point de l'Épine des Champs, Buroplus, Bât D; 78990 Elancourt; + 33 (0)1 30 68 89 56; +33 (0)1 30 68 89 99 francesales@teseq.com; www.ametek-cts.com
Produits et services: Amplifiers (RF & Microwave), Antennas, Automotive Systems, Conducted RF immunity,

Conducted Surge & Transients, ESD, Harmonics & Flicker, GTEM cells, RF Immunity Systems, RF Emission Systems, RF Testsoftware, Calibration & Service

W



Würth Elektronik France

1861 Avenue Henri Schneider CS 70029, 69881 Meyzieu CedexTel., France
 +33 (0) 427 86 11 00; eiSos-france@we-online.com
Produits et services: Ferrites, câble et fiche

ASSOCIATIONS

ASSOCIATION FRANÇAISE DE LA COMPATIBILITÉ ELECTROMAGNÉTIQUE

Pour la promotion et le développement de la Compatibilité ElectroMagnétique
 Association régie par la loi du 1er juillet 1901, 86 rue de la Liberté – 38180 SEYSSINS
 01 43 86 13 96; Fax: 01 43 86 09 40
 contact@afcem.org; www.afcem.org/index.asp

IEEE EMC SOCIETY CHAPTER FRANCE

André Berthon, Admittance, 11 rue Bertron, F-92330 Sceaux, France
 +331 433 45231; aberthon@club-internet.fr

NOTIFIED BODIES

AEMC LAB

19 rue François Blumet, ZI de l'Argentière F38360, Sassenage, France
 +33 04 76 27 83 83; Fax: +33 04 76 27 77 00
 aemc.lab@wanadoo.fr

ASEFA

33 avenue du Général Leclerc 92260 Fontenay-aux-Roses, France
 +33 1 40 95 63 34; Fax: +33 1 40 95 88 18
 asefa@lclie.fr

ASEFA - PLATE FORME F 03 - SCHNEIDER ELECTRIC INDUSTRIES

37 quai Paul Louis Merlin, 38050 Grenoble cedex 9, France
 +33 4 76 39 85 51; Fax: +33 4 76 57 99 38
 william.magnon@schneider-electric.com
 www.schneider-electric.com

ASEFA - PLATE FORME P 01 - LEGRAND

128 avenue du Maréchal de Lattre de Tassigny, F87045 Limoges cedex, France
 +33 5 55 06 87 87; Fax: +33 5 55 06 88 88
 didier.leblanc@legrand.fr

ASEFA - PLATE FORME V 01 - ALSTOM TRANSPORT

11-13 Avenue de Bel Air 69627 Villeurbanne Cedex, France
 +33 4 72 81 46 27
 carlos-queiros-de-oliveira@transport.alstom.com
 www.alstom.transport.com

CENTRE TECHNIQUE DES INDUSTRIES MECANIQUES

52 Avenue Felix Louat - BP 80067, F60304 Senlis Cedex,
 +33 3 44 67 30 00; Fax: +33 3 44 67 34 00
 sqr@cetim.fr; www.cetim.fr

EMITECH ATLANTIQUE

Rue de la Claire 15, ZI Angers-Beaucouzé, 49070 Beaucouze, France
 +33 2 41 732627; Fax: +33 241 7326.40
 atlantique@emitech.fr; www.emitech.fr

EMITECH - CHASSIEU

7, rue Georges Méliès, F 69680 Chassieu, France;
 +33 478 406655; Fax: +33 472 470039; chassieu@emitech.fr; www.emitech.fr

EMITECH GRAND SUD

Rue du Massacan 145, ZI Vallée du Salaison, BP 25, 34741 Vendargues Cedex, France
 +33 467 871102; Fax: +33 467 709455
 grand-sud@emitech.fr; www.emitech.fr

EMITECH ILE DE FRANCE

Z.A. de l'Observatoire 3 rue des Coudriers, 78180 Montigny Le Bretonneux, France
 +33 1 30 57 55 55; Fax: +33 1 30 43 74 48
 contact@emitech.fr; www.emitech.fr

EMITECH - LE RHEU

2 allée du Chêne Vert F35650 Le Rheu, Le Rheu, France
 +33 299 14 5914; +33 299 146454
 lerheu@emitech.fr; www.emitech.fr

EUROCEM

364, rue Armand Japy Technoland, 25460 Etupes, Cedex, France
 +33 381 907590; Fax: +33 381 3236 28
 s.afflard@eurocem.fr; commercial@eurocem.fr;
 www.eurocem.fr

GYL TECHNOLOGIES

Parc d'activités de Lanserrie 21 rue de la Fuye F49610 Juigne sur Loire, Juigne sur Loire, France
 +33 241 575740; Fax: +33 2414525 77; gyl@gyl.fr

GROUPE D'ETUDES ET DE RECHERCHES APPLIQUÉES À LA COMPATIBILITÉ

105 avenue du Général Eisenhower BP 23705 F 31037 Toulouse cedex 01, Toulouse, France
 +33 561 1946 50; Fax: +33 561 194668
 toulouse@gerac.com

INSTITUT NATIONAL DE L'ENVIRONNEMENT INDUSTRIEL ET DES RISQUES

Parc Technologique Alata BP 2, F60550 Verneuil-en-Halatte, France
 +33 344 556677; Fax: +33 344 556699
 pierre.gruet@ineris.fr; www.ineris.fr

LABORATOIRE CENTRAL DES INDUSTRIES ELECTRIQUES

33 avenue du Général Leclerc BP 8, F92266 Fontenay-aux-Roses cedex, France
 +33 140 956060; Fax: +33 140 955407
 contact@lclie.fr; www.lclie.fr

LABORATOIRE NATIONAL DE MÉTROLOGIE ET D'ESSAIS

1, rue Gaston Boissier, 75724 PARIS CEDEX 15, France
 +33 140 433700; Fax: +33 140 433737
 info@lne.fr; www.lne.fr

LABORATOIRE CENTRAL DES INDUSTRIES ELECTRIQUES - ETABLISSEMENT SUD-EST

ZI Centr'Alp 170 rue de Chatagnon F38430 Moirans, France
 +33 476 073636; Fax: +33 476 559088
 contact@lclie.fr; www.lclie.fr

UNION TECHNIQUE DE L'AUTOMOBILE

Autodrome de Linas-Monthéry BP 20212 91311 Monthéry Cedex, France
 +33 169 801700; Fax: +33 169 801717
 christian.pichon@utac.com; www.utac.com

OTHER

MINISTÈRE DE L'ECONOMIE, DES FINANCES ET DE L'INDUSTRIE DIGITIP/ SPIC/SQUALPI DIGITIP 5

Le Bervil, 12 rue Villiot, F-75572 Paris Cedex 12
 +33 015 3449703; Fax: + 33 015 3449888
 Michel Berger, michel.berger@finances.gouv.fr



**Amplifiers...
For Every Application!**

**Solid State • TWT • Tetrode Tube
DC - 40 GHz • up to 10 kW**



RF/Microwave Amplifiers

Represented by
AMETEK S.A.S., Compliance Test Solutions • 78990 ELANCOURT • France
Tel: +33 (0)1 30 68 89 56 • sales.cts@ametek.com • www.cts.ametek.com

IFI - Instruments For Industry • 903 South Second Street • Ronkonkama, NY 11779
Tel: +1 631 467 8400 • Fax: +1 631 467 8558 • sales@ifi.com • www.ifi.com

AMETEK®
COMPLIANCE TEST SOLUTIONS

Nouvelles Exigences et Méthodes de Tests de l'UE pour l'Équipement de Transmission de Données ISM 2,4 GHz

DAVID ZHANG¹, NIMA MOLAEI¹, LESLIE BAI²

Compliance Engineers¹; President and CEO²
SIEMIC Laboratories

Résumé—De nouvelles exigences de la Directive de l'Union Européenne ont été introduites pour l'équipement de transmissions de données ISM 2,4 GHz, qui seront mises en application à partir du 1er janvier 2015. Cet article présente un aperçu des exigences de conformité et fournit une analyse détaillée des différences entre la norme actuelle ETSI EN 300 328 V1.7.1 (2006) et la nouvelle norme ETSI EN 300 328 V1.8.1 (2012). Une introduction des méthodes de test nouvellement requises est également comprise, ainsi que certains montages de test uniques.

Mots clés – UE, Union européenne, R&TTE, ISM, ETSI, EN 300 328, SIEMIC

New European Union Directive requirements have been introduced for 2.4GHz ISM Data Transmission Equipment, which will be in effect starting January 1, 2015. This article presents an overview of the regulatory compliance requirements, and provides a detailed analysis on the differences between the current standard ETSI EN 300 328 V1.7.1 (2006) and the new standard ETSI EN 300 328 V1.8.1 (2012). Also included is an introduction to the new required test methods, as well as some of the unique test setups. To read this article in English, visit our website www.interferencetechnology.com.

I. INTRODUCTION

POUR RÉGULARISER le marché des consommateurs et protéger les résidents de l'Union européenne (UE), des règlements, directives, décisions recommandations et opinions sont développées et négociées parmi les pays membres. Ces obligations légales couvrent divers aspects des produits, y compris la sécurité, la santé et la protection de l'environnement, ainsi que la protection des infrastructures publiques telles que les systèmes de télécommunication et le spectre des fréquences. En mai 1985, la « Nouvelle approche de l'harmonisation technique et des normes » de l'UE a été définie, et elle représentait une manière innovante de réaliser l'harmonisation technique. Cette approche a clairement introduit la séparation des responsabilités entre les législateurs de la Commission européenne (CE) et les organismes de normalisation européens dans le cadre légal, comprenant le Comité Européen de la Normalisation (CEN), le Comité Européen de la Normalisation Électrotechnique (CENELEC) et L'Institut des Normes de Télécommunications Européennes (ETSI).

En gros, les directives de la CE définissent les exigences essentielles, et les organismes de normalisation de l'EU ont la responsabilité de développer les spécifications techniques correspondantes nécessaires pour se conformer aux exigences essentielles des directives, que l'on appelle les normes. Ces normes approuvées sont

publiées dans le Journal Officiel (JO) de la CE et deviennent les normes harmonisées de l'UE. La conformité à ces normes assure une présomption de conformité aux exigences pertinentes de la législation harmonisée. En conséquence les fabricants, les organismes d'évaluation de la conformité et les autres acteurs économiques participants peuvent utiliser ces normes harmonisées pour démontrer que les produits, services et processus sont conformes à la législation pertinente de l'UE.

Les trois organismes de normalisation qui sont le CEN, le CENELEC et l'ETSI sont responsables de la préparation de normes harmonisées selon la directive de la CE dite « Radio and Telecommunications Terminal Equipment » (R&TTE) (1999/5/EC), qui a été publiée au JO de la CE le 7 avril 1999. La directive couvre tous les équipements de radio et de télécommunication destinés à être connectés aux réseaux de communication et de radio publics dans l'UE.

En juin 2012, l'ETSI a mis à jour deux normes qui ont été ajoutées au JO de la CE en octobre 2012 et qui seront mises en application le 1er janvier 2015, devenant les normes de l'UE harmonisées et officielles à cette date. Ces deux normes sont :

- ETSI EN 300 328 V1.8.1- Équipement de transmission de données fonctionnant dans la bande 2, 4 GHz ISM et utilisant les techniques de modulation large bande ;
- ETSI EN 301 893 V1.7.1- RLAN à haute performance 5 GHz ;

Ces deux normes concernent une vaste gamme de produits, dont WLAN, Bluetooth, ZigBee, télécommandes 2,4 GHz, et produits PTP fixes. Les deux normes ETSI fournissent une présomption de conformité à l'Article 3.2 de la Directive R&TTE. Toutefois, les versions actuelles de ces normes cesseront de fournir une présomption de conformité le 31 décembre 2014, donc les Déclarations de conformité UE (DOC) pour la Directive R&TTE basées sur la norme EN 300 328, V1.7.1 devront être réévaluées avant la fin de 2014 par rapport à la nouvelle norme V1.8.1.

Dans cet article, nous allons nous concentrer sur la norme EN 300 328 V1.8.1, qui comporte des changements importants par rapport à la version actuelle V1.7.1, à la fois dans les exigences techniques et les méthodes de test à utiliser pour évaluer la conformité.

II. ANALYSE DÉTAILLÉE DE EN 300 328: V1.7.1 CONTRE V1.8.1

Comme nous l'avons dit, il y a de nombreuses mises à jour dans la version V1.8.1 de ETSI EN 300 328. Les raisons données pour la mise à jour de cette norme sont l'amélioration de l'usage et de la qualité de l'équipement de transmission de données fonctionnant dans la bande ISM 2,4 GHz, et de rendre la norme plus générique, de manière à couvrir tous les différents types de produits possibles.

ETSI EN 300 328 V1.7.1 a été ajoutée au Journal Officiel en tant que norme harmonisée en décembre 2009.

Cette version a ajouté une exigence de partage du spectre en stipulant qu'un protocole d'accès à un média doit être implémenté et ciblé pour des conceptions d'équipements basées sur un protocole standard international tel que IEEE (Institute of Electrical and Electronics Engineers) 802.11, IEEE 802.11n, ou IEEE 802.15.4.

Il n'y avait aucune méthodologie de test clairement définie pour le partage du spectre dans V1.7.1, ce qui a causé de nombreux malentendus et beaucoup de confusion. Les tests en laboratoire ne sont pas toujours certains de la manière d'effectuer une évaluation pour ces exigences de conformité, et doivent en général se fier à une déclaration du fabricant selon laquelle l'équipement est muni d'un mécanisme pour utiliser le partage du spectre. Mais certains fabricants ne veulent pas fournir de déclaration de cette sorte, parce qu'ils considèrent que le laboratoire de tests doit effectuer l'évaluation et fournir les conclusions en matière de conformité.

Ceci crée des difficultés lorsque l'équipement doit être testé à cette norme, et nous n'avons pas une bonne solution. Pour les appareils Wi-Fi, Bluetooth, et ZigBee, qui ont été conçus avec des mécanismes spécifiques de partage du spectre implémentés selon le protocole IEEE, la conformité peut être obtenue en se basant sur la déclaration. Mais dans les cas où l'équipement n'est pas conçu selon un protocole IEEE standard, comment peut-on évaluer la capacité à partager le spectre ?

Cette situation sera traitée avec l'adoption de la nouvelle version V1.8.1 de la norme. Le Protocole d'accès au média sera remplacé par des exigences de tests d'adaptabilité, et la nouvelle version comporte des exigences techniques détaillées sur le seuil et la relation temporelle de détection d'interférences. Elle fournira aussi des procédures de tests pas à pas permettant de s'assurer que les nouvelles exigences seront suivies de manière plus efficace.

Les options suivantes pour le mécanisme de partage du spectre sont comprises dans la version V1.8.1 :

- Pour les systèmes à Étalement de spectre par saut de fréquence (Frequency Hopping Spread Spectrum, FHSS)
 - o Systèmes adaptatifs
 - Détecter et éviter (Detect and Avoid, DAA) basé sur Écouter avant de parler (Listen Before Talk, LBT)
 - Autres formes de DAA (non LBT)
 - o Systèmes non adaptatifs
 - Utilisation d'un média (Medium Utilisation, MU)
- Pour les systèmes non FHSS (tous les autres)
 - o Systèmes adaptatifs
 - DAA basé sur LBT
 - Autres formes de DAA (non LBT)
 - o Systèmes non adaptatifs
 - Utilisation d'un média (Medium Utilisation,

MU)

Des changements supplémentaires ont été faits sur d'autres tests requis dans le but de rendre la norme plus générique, afin de couvrir les différents types d'équipements qui fonctionnent dans la bande de fréquences de 2,4 GHz. Les exigences techniques ont été séparées en deux types principaux d'équipements de large bande. Le premier est l'équipement FHSS (Étalement de spectre par saut de fréquence), et le second est l'équipement de Modulation de large bande autre que FHSS.

Dans le Tableau 1 vous trouverez un bref résumé des principales différences au niveau des exigences techniques entre EN 300 328 V1.7.1 et EN 300 328 V1.8.1. Les principaux changements dans la version V1.8.1 sont :

- Puissance de sortie RF : De nouvelles exigences pour les instruments de test et de nouvelles procédures de tests sont ajoutées, plus la considération pour les MIMO (Multiple Input-Multiple Output, Entrées multiples-sorties multiples), mais les limites restent les mêmes.
- Émissions indésirables des émetteurs : Ajoute les exigences pour les émissions dans le domaine hors bande (Out Of Band, OOB), et définit une gamme de fréquences qui s'étend à une zone éloignée de deux bandes passantes de la fréquence opérationnelle. La procédure de test associée est également définie. Pour les domaines d'émissions parasites, le détecteur de mesure est changé, et il exige l'utilisation de points à haute résolution lors du balayage afin d'obtenir des données de test précises. Enfin, les mesures pré-balayage et finales sont définies séparément.
- Densité spectrale de puissance : Ceci a été normalisé aux résultats de mesure de puissance obtenus, et la nouvelle procédure de test exige des calculs considérables, mais les limites restent inchangées.
- Gamme de fréquences : La procédure des tests a changé pour utiliser une mesure de 99 pour cent de la bande passante, à effectuer uniquement dans les conditions normales.
- Adaptabilité et blocage du récepteur : Les appareils adaptatifs et non-adaptatifs fonctionnant à plus de 10 dBm PIRE, (Puissance isotrope rayonnée équivalente) sont maintenant soumis à de nouvelles restrictions en matière de relation temporelle. De plus, l'équipement adaptatif devra être capable de détecter une interférence, et de cesser l'émission lorsqu'une interférence est détectée.

III. MÉTHODES DE TESTS POUR PRENDRE EN CHARGE ETSI EN 300 328 V1.8.1

Avec les changements aux exigences techniques, les procédures de test sont également redéfinies pour fournir des méthodes plus appropriées pour évaluer la conformité des produits. Les procédures de tests deviennent également plus génériques pour utilisation dans

différents types d'équipement.

Conditions ambiantes

Les conditions des tests ont changé depuis V1.7.1 où les conditions ambiantes extrêmes et les critères des alimentations devaient suivre les exigences décrites dans la clause 5.3, mais dans V1.8.1 elles sont déclarées par le fabricant, en se basant sur les conditions d'utilisation réelles de l'équipement.

Conditions d'utilisation de l'Unité sous test (UUT, Unit Under Test)

Pour les conditions d'utilisation de l'UUT selon V1.8.1, l'unité doit être configurée pour le mode d'utilisation normale, ce qui signifie que l'UUT peut avoir un facteur d'utilisation irrégulier et différentes caractéristiques d'émission, selon le type d'équipement et le mode d'utilisation spécifique. Dans la version actuelle V1.7.1, l'UUT doit être configurée en mode d'émission de test continu (facteur d'utilisation de 100%). Le problème, c'est que ce type de mode exige l'utilisation par le fabricant d'outils ou de logiciels spéciaux qui sont parfois difficiles à obtenir ; et la performance RF réelle de l'équipement peut ne pas être à la hauteur des attentes lors d'un mode d'utilisation normal utilisé lors des tests de conformité. Il existe aussi un potentiel de « déformation » des résultats en utilisant un mode de tests spécial préparé délibérément par un fabricant dans le seul but de faire passer les tests à l'UUT. La nouvelle règle dans V1.8.1 traite effectivement ce problème et exige que toutes les mesures soient effectuées dans le mode d'utilisation normal, ce qui rend les mesures cohérentes et plus précises.

Mesure de la puissance de sortie RF

Pour la mesure de puissance de sortie RF, un capteur de puissance rapide adéquat pour 2,4 GHz et capable de 1 MS/s (million d'échantillons par seconde) doit être utilisé. L'échantillon mesuré doit représenter la puissance du signal. La durée de la mesure est définie pour l'équipement adaptatif ainsi que non-adaptatif, afin d'améliorer la précision. Alors que des méthodes de mesure par radiation ou par conduction peuvent être utilisées, elles doivent toutes suivre le même cheminement d'acquisition des données pour obtenir les résultats.

- Pour des mesures par conduction sur des appareils ayant une seule chaîne d'émission, échantillonnez le signal d'émission et enregistrez les données brutes.
- Pour les mesures par conduction sur des appareils ayant de multiples chaînes d'émission, des mesures doivent être effectuées sur tous les ports d'émission simultanément. La puissance des échantillons individuels sur tous les ports doit être enregistrée et vous devez faire la somme.
- Pour les mesures par radiation, l'UUT doit être configurée et l'(les) antenne(s) positionnées pour des niveaux de PIRE maximum en direction de l'antenne de

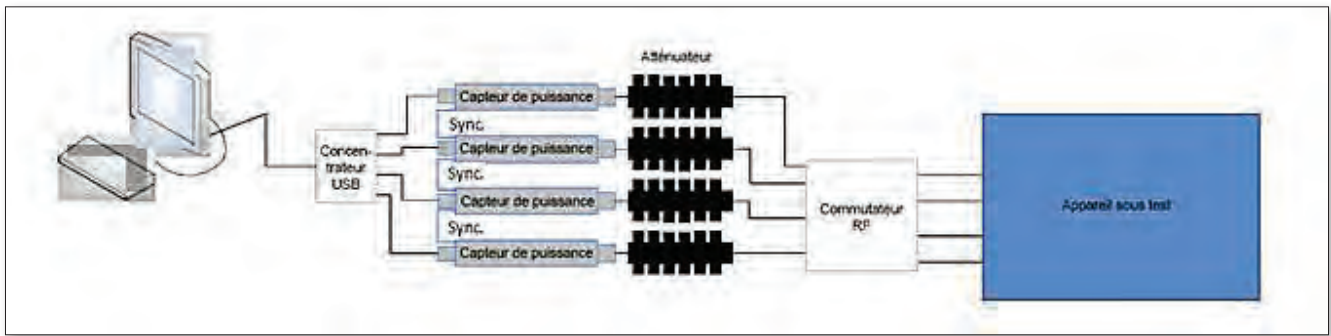

FIGURE 1: Montage de test pour le test de puissance de sortie RF

mesure, y compris les systèmes d'antenne intelligente et les systèmes capables de former un faisceau. Le capteur de puissance rapide est également requis pour la mesure ; un analyseur de spectre ne doit pas être utilisé.

Les temps de démarrage et d'arrêt de chaque rafale sont enregistrés et doivent être utilisés pour calculer la valeur RMS (efficace) sur la période de la rafale. Le calcul de la PIRE maximum pour déterminer la puissance de sortie RF (P) fait la somme de trois valeurs mesurées, la plus haute valeur de rafale (A), le gain du montage d'antenne (G) et le gain supplémentaire de formation de faisceau (Y) selon la formule :

$$P = A + G + Y$$

L'utilisation de capteurs de puissance rapides et de mesures simultanées pour les chaînes MIMO élimine la possibilité d'utiliser une méthode alternative pour la mesure de puissance. Les capteurs de puissance spéciaux et uniques qui peuvent être conformes aux exigences de V1.8.1 sont en train de devenir très recherchés sur le marché des équipements de test. Nous allons maintenant aborder la méthode pour les principaux éléments de test.

Le test de la puissance de sortie RF sera basé sur l'utilisation de capteurs de puissance rapides, et peut exiger l'utilisation de 4 capteurs de puissance simultanément pour des appareils MIMO 4x4. Un montage de test suggéré est montré en Figure 1.

Densité spectrale de puissance

La densité spectrale de puissance (PSD) peut être mesurée au moyen d'un analyseur de spectre de haute résolution. Le détecteur à utiliser peut être défini de manière spécifique comme un détecteur RMS, plutôt qu'un détecteur de puissance moyenne référencé dans la version V1.7.1. Les points de balayage dans la gamme de fréquences de mesure sont définis pour assurer que la précision nécessaire est atteinte. Si l'analyseur de spectre utilisé ne prend pas en charge assez de points de balayage, la bande des fréquences peut être segmentée.

Selon la procédure définie dans V1.8.1, la mesure de la PSD ne se limite pas à faire un balayage à l'analyseur de spectre et à marquer l'amplitude la plus haute. Un balayage est effectué avec une bande passante de résolution

(RBW, Resolution Bandwidth) de 10 kHz et une bande passante de vidéo (VBW, Video Bandwidth) de 30 kHz, en utilisant un détecteur RMS, tout en capturant plus de 8350 points de balayage. Ensuite, toutes les valeurs dans le balayage sont ajoutées et normalisées à la puissance PIRE de sortie RF pour obtenir le facteur de normalisation, qui incorporera toutes les valeurs individuelles pour produire l'amplitude normalisée. Cette mesure s'effectue en partant du premier échantillon du fichier (la plus basse fréquence), puis en ajoutant la puissance des échantillons suivants en segments de 1 MHz, et en enregistrant les résultats pour la puissance et la position (c.-à-d. échantillon no 1 à no 100), puis en répétant les mesures en décalant le point de départ des échantillons de 1, puis en répétant la procédure pour toutes les valeurs individuelles jusqu'à ce que toutes les valeurs aient été couvertes. L'échantillon du segment de 1 MHz le plus élevé sera la valeur de PSD maximale.

Émissions parasites de l'émetteur dans le domaine hors bande

C'est un nouvel élément ajouté dans la version V1.8.1. Le but est de limiter les émissions indésirables de l'émetteur dans le domaine hors bande (OOB, Out Of Band) sur les fréquences immédiatement à l'extérieur de la bande passante requise, qui résultent du processus de modulation, mais exclut les émissions parasites. Cette mesure s'effectue en utilisant la fonction de Mesure de la puissance dans le domaine temporel avec un analyseur de spectre. Le détecteur de mesure est en mode RMS, et au moins 5000 points de balayage sont requis. La gamme de fréquence mesurée dépend de la bande passante de fonctionnement de l'UUT (Operating Bandwidth, OBW), de (2400 MHz – 2BW) à (2483.5 MHz + 2BW). Avec une bande passante de résolution (Resolution Bandwidth, RBW) de 1 MHz et SPAN (Plage) réglé à 0 Hz, la mesure de Puissance dans le domaine temporel doit être répétée à chaque fréquence centrale qui se trouve à 1 MHz de la limite de chaque gamme de fréquence de la bande ISM (Industrielle, Scientifique et Médicale) définie. Semblable à la mesure de puissance de sortie RF, le gain déclaré du montage d'antenne « G » en dBi doit être ajouté aux résultats pour chacun des segments de 1 MHz. Pour les équipements ayant des chaînes d'émission multiples, les mesures doivent être répétées pour chacune des chaînes d'émission actives. La

TABLEAU 1

Élément de test	EN 300 328 V1.7.1(2006-10)	EN 300 328 V1.8.1(2012-07)
Types d'équipement	FHSS et DSSS	FHSS, autres modulation de large bande, équipement adaptatif et non-adaptatif.
Puissance de sortie RF	PIRE maximum 100mW	PIRE moyenne 100mW (il est nécessaire de considérer le gain de formation de faisceau)
Densité spectrale de puissance (non-FHSS seulement)	Densité spectrale de PIRE 10dBm/MHz maximum	Densité spectrale de PIRE moyenne 10dBm/MHz
Facteur d'utilisation, séquence d'émission, trou d'émission	Non définis	Le facteur d'utilisation doit être inférieur ou égal à la valeur maximale déclarée. - Pour FHSS : temps de séquence d'émission max ≤ 5 ms, temps d'interruption d'émission min ≥ 5 ms - Pour non-FHSS : temps de séquence d'émission = Min. Temps d'interruption d'émission = M (Note : $3,5\text{ms} < M < 10\text{ms}$)
Temps de pause, occupation de fréquence minimum et séquence de saut (FHSS uniquement)	Exigence de saut de fréquence : Temps de pause $< 0,4$ s Canal de saut, séquence de saut	Temps de pause, occupation de fréquence minimum et séquence de saut Séparation de la fréquence de saut : nouvelles limites ;
Protocole d'accès au média	Un protocole d'accès au média doit être implémenté	Un protocole d'accès au média doit être implémenté Facteur d'utilisation du média pour l'équipement non-adaptatif avec PIRE > 10 mW ; Limite : $\leq 10\%$
Adaptabilité	Pas de spécification	Uniquement pour l'équipement adaptatif avec PIRE > 10 mW
Bande passante occupée	Pas de spécification	99% de l'OBW doit être comprise dans la bande utilisée. Équipement FHSS et non-AFH (PIRE > 10 dBm) : bande passante du canal occupé ≤ 5 MHz Équipement non-FHSS et non-AFH (PIRE > 10 dBm) : bande passante du canal occupé < 20 MHz
Émission indésirable de l'émetteur dans le domaine hors bande	Pas de spécification	Spécifie le masque limite pour les émissions indésirables hors bande.
Émission parasite de l'émetteur	Définie	Limite inchangée, mais le réglage de mesure du RBW et du détecteur a changé.
Émissions parasites du récepteur	Définie	Limite inchangée, mais le réglage de mesure du RBW et du détecteur a changé.
Blocage du récepteur	Pas de spécification	uniquement pour l'équipement adaptatif avec PIRE > 10 mW

ETSI EN 300 328 versions V1.7.1 et V1.8.1

plus haute valeur dans chacun des segments de 1 MHz est la plus haute émission parasite de l'émetteur dans le domaine OOB.

Adaptabilité et blocage du récepteur

Un des changements les plus importants dans la version V1.8.1 est l'ajout d'une exigence de test d'Adaptabilité et de blocage du récepteur, qui teste la manière dont l'équipement s'adapte à son environnement en identifiant les autres émissions présentes dans la gamme, puis en « adaptant » par l'exclusion de ses fréquences et canaux de fonctionnement sélectionnés. L'adaptabilité fait partie des exigences pour le partage du spectre. On l'appelle le « Mécanisme du protocole d'accès au média » et il se fait essentiellement à la déclaration du fabricant. Les produits WLAN ou ZigBee sont conçus selon des normes telles que IEEE 802.11 ou IEEE Std. 802.15.4, et ils ont un mécanisme de partage du spectre LBT basé sur le mode de l'évaluation du canal libre (CCA, Clear Channel Assessment) qui détecte l'énergie RF de manière à pouvoir se conformer aux exigences de partage du spectre. Toutefois, il existe des exigences techniques détaillées et des procédures de tests définies dans V1.8.1 dans le but d'évaluer les appareils

qui ne sont pas munis de ce type de mécanisme de partage du spectre standardisé. Le concept d'adaptabilité est aussi compliqué par la profondeur des détails nécessaires dans la norme pour qu'elle soit suffisamment générique pour couvrir les divers types d'équipements adaptatifs qui pourraient être introduits.

Pendant le test, un signal de bruit de bande large est injecté dans le port d'antenne de l'UUT, tel qu'un signal d'interférence centré sur la fréquence de saut ou la fréquence de fonctionnement sous test. Le signal d'interférence doit être un signal de bruit d'une bande limitée ayant une PSD plate. En général ce type de signal est généré par la fonction de génération de « bruit blanc gaussien adaptatif (AWGN, Adaptive White Gaussian Noise) sur un générateur de signal vectoriel.

Les tests d'adaptabilité et de blocage du récepteur sont combinés et effectués ensemble, et une configuration de test typique est montrée en Figure 2. La procédure de test contient les étapes basiques suivantes :

Étape 1 : Connecter l'UUT et les appareils auxiliaires, puis connecter le générateur de signal d'interférence, le générateur de signal de blocage et l'analyseur de spectre. L'analyseur de spectre est utilisé pour mesurer les émis-

sions de l'UUT en réponse aux signaux d'interférence et de blocage.

Étape 2 : Configurer l'UUT pour des émissions normales

avec une charge suffisante qui permette de démontrer la conformité du mécanisme d'adaptation sur les fréquences de saut testées. Puis vérifier le temps d'occupation du canal par l'UUT et la période d'attente minimale.

Étape 3 : Ajouter le signal d'interférence.

Étape 4 : Vérifier la réaction du mécanisme de partage du spectre au signal d'interférence.

Étape 5 : Ajouter le signal de blocage, et vérifier la réaction de l'UUT.

Étape 6 : Retirer les signaux d'interférence et de blocage, puis vérifier la réaction de l'UUT.

Noter que l'UUT est autorisée à émettre des signaux de contrôle après la détection du signal d'interférence, à condition que le facteur d'utilisation du signal de contrôle ne dépasse pas la limite donnée dans la norme.

Un montage de test typique pour le test d'adaptabilité et de blocage du récepteur est montré en Figure 2.

IV. CHANGEMENTS UNIQUES DU MONTAGE DE TEST DANS ETSI EN 300 328 V1.8.1

La norme EN 300 328 V1.8.1 spécifie les exigences pour les mesures, les fonctions, performances et réglages des instruments de test, qui sont très différentes des exigences de V1.7.1. Certaines des exigences les plus uniques de l'équipement de test comprennent :

- Capteurs de puissance rapides pour 2,4 GHz, et capables 1 MS/s (1 million d'échantillons par seconde) pour la mesure de puissance de sortie RF, et la nécessité de prendre en charge des mesures simultanées sur les appareils MIMO.
- Des analyseurs de spectre à haute performance avec
 - plus de 30 000 points d'échantillonnage de balayage pour le temps de latence, l'occupation de fréquence minimum et la mesure de séquence de saut
- Des analyseurs de spectre avec détecteurs RMS pour
 - la plupart des mesures
- Des fonctions de mesure de la puissance dans le domaine temporel pour les émissions parasites de l'émetteur dans le domaine hors bande (OOB).
- Les sources de bruit en large bande doivent avoir moins de 1,5 dB d'ondulation résiduelle pour les tests d'adaptabilité

Noter aussi qu'un générateur de bruit blanc gaussien adaptatif (AWGN, Adaptive White Gaussian Noise) pour soutenir des bandes passantes de bruit à plus de 160 MHz sera requis si le test est effectué sur un appareil CA 802.11 ayant une bande passante de 160 MHz.

Le Tableau 1 compare les changements pour douze critères de test principaux entre la norme actuelle ETSI EN 300 328 V1.7.1 et la norme ETSI EN 300 328 V1.8.1

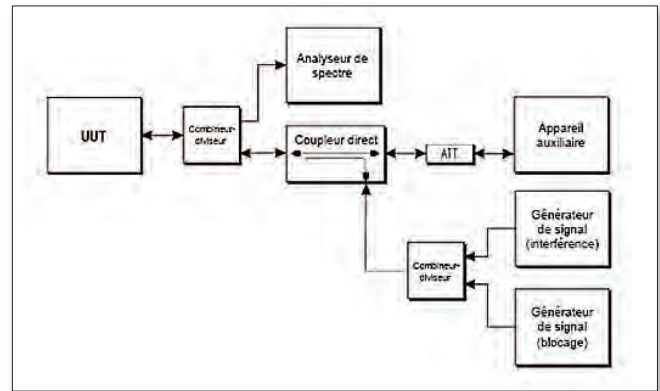

FIGURE 2 : Montage de test pour le test d'adaptabilité et de blocage du récepteur

qui sera bientôt implémentée.

V. DÉVELOPPEMENTS FUTURS POUR ETSI EN 300 328

Alors que les fabricants et les laboratoires de test font actuellement la transition vers la norme EN 300 328 V1.8.1, ETSI a déjà publié une version préliminaire de EN 300 328 V1.8.2. Cette version est actuellement soumise au processus d'approbation pour les Normes européennes, avec une réunion de résolution prévue en septembre 2014, suivie d'un vote national supplémentaire sur la version modifiée, s'il y a des commentaires. La version finale qui réussira le vote national sera publiée sous le nom de EN 300 328 V1.9.1, ce qui est prévu dans le courant de 2015.

Certains des changements possibles dans la version future V1.8.2 pourraient inclure :

- Pour FHSS, il y a des changements proposés pour certaines définitions, comme le temps de pause, ainsi que certaines exigences techniques et les méthodes de test correspondantes.
- Pour les systèmes adaptatifs non-FHSS et basés sur LBT tels que IEEE 802.15.4 et IEEE 802.11, les exigences et méthodes de test pour l'adaptabilité seront clarifiées. Les formules pour calculer le « temps CCA étendu » et le « temps d'occupation du canal » ont été supprimées et remplacées par des valeurs fixes, ou une gamme de valeurs fixes.
- Des changements pour les tests d'émission parasite pour le réglage d'instruments type détecteur, y compris une clarification selon laquelle le test par radiation doit être effectué sur l'UUT, même si le test RF par conduction est effectué.

RÉFÉRENCES

- URL: www.siemic.com
- URL: www.etsi.org
- ETSI EN 300 328 V1.8.1: 2012
- ETSI EN 300 328 V1.8.2: 2014 (Version préliminaire)
- Présentation sur EN 300 328 & EN 301 893, réunion CA sur R&TTE – Amsterdam – mai 2014
- Article 288 sur le Traité sur le fonctionnement de l'Union européenne

ITALIA



86 PRODOTTI E SERVIZI

88 RISORSE

90 ARTICLES

Il Primo Approccio Pratico All'Emc per la Sicurezza Funzionale

KEITH ARMSTRONG, Cherry Clough Consultants

Perdere tempo è perdere denaro.

Test di immunità radiata ridotti da giorni ad ore ...



utilizzando il nostro nuovo tester Multistar Multi-Tone

L'accuratezza dei test EMC è fondamentale, ma impiegare troppo tempo per il test, può essere costoso e ritarda i tempi di commercializzazione. Con la velocità del rivoluzionario tester Multistar Multi-Tone, non ti devi più dilungare in tediosi tests per immunità irradiata.

Ottimizza la tua attività durante il tempo di misura, testando frequenze multiple simultaneamente. In questo modo rendi più veloce la prova ed immetti il tuo prodotto rapidamente sul mercato, oltre ad aver eliminato i costosi colli di bottiglia.

Simulare gli effetti elettromagnetici del mondo reale è possibile sottoponendo l'EUT a più di una frequenza alla volta. Il tester Multistar Multi-Tone è conforme ai requisiti della norma IEC 61000-4-3 ed a tutte le norme collegate.

Così, se pensi che perdere tempo significhi perdere denaro, non indugiare.

Chiedi informazioni del nostro nuovo tester Multistar Multi-Tone e del nuovo ricevitore EMI DSP-based. Velocità incredibile, incredibile accuratezza. www.ar-europe.ie/multiTone

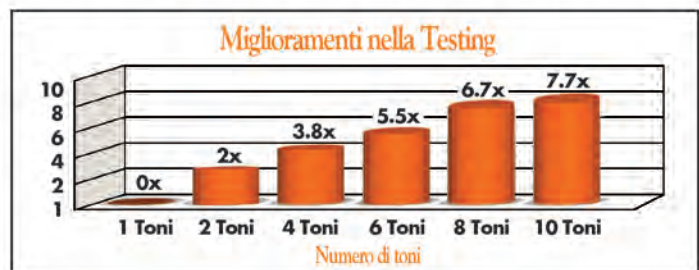

IEC 61000-4-3 1% di step durante il tempo di test

sales@teseo.net

+39 01 19941911

ISO 9001:2008
Certified

ar europe

National Technology Park, Ashling Building, Limerick, Ireland • +353 61 504300 • www.ar-europe.ie

In Europe, call ar United Kingdom +44 1908 282766 • ar France +33147917530 • ar Deutschland +49 6101 802700 • ar Benelux +31 172 423000

www.arworld.us

Copyright © 2014 AR. The orange stripe on AR products is Reg. U.S. Pat. & TM. Off.

PRODOTTI e SERVIZI

A



A.H. Systems, Inc.

NARDA Safety Test Solutions s.r.l., Via Leonardo Da Vinci 2½3, 20090, Segrate (MI), Italia
+39-02-22699871; Fax: +39-02-26998700
support@narda-sts.it; www.AHSystems.com
TESEO S.p.A., C.so Alexander Fleming, 25/27/29, 10040, Druento, Italia
+39-011-9941911; Fax: +011 39-011-9941900
f.chinalgia@teseo.clemessy.com
www.AHSystems.com
Prodotti e servizi: Antenne, Strumentazione per test, Test



AR / RF Microwave Instrumentation

Teseo S.p.A., C.so Alexander Fleming, 25/27/29, Druento, Italia 10040
+39 01 19941911; Fax: +39 01 19941900
Stefano Serra, sales@teseo.net.; www.teseo.net
Prodotti e servizi: Amplificatori, Antenne, Cavi e connettori, Stanze e spazi schermati, Oscillazioni di tensione e sovratensioni temporanee, Strumentazione per test

AFJ INTERNATIONAL Srl

Via G. Watt, Milano, 12 -20143 Italia
+39 02 89159140; Fax: +39 02 89159226
info@afj.it; www.afj.it
Prodotti e servizi: Filtri, Strumentazione per test

Arrow Europe

viale F.testi 280 20126 Milano, Italia
+39 02 66 12 51; Fax: +39 02 66 10 5156
www.arroweurope.com
Prodotti e servizi: Ferriti, Cavi e connettori, applicazioni di potenza

C

Carlisle Interconnect Technologies

United Kingdom; +44-7817-731-000
Andy Bowne, Andy.Bowne@carlisleit.com
www.CarlisleIT.com
Prodotti e servizi: Filtri

Comtest Engineering bv

Industrieweg 12, 2382 NV Zoeterwoude
The Netherlands
+31-71 5417531; Info@comtest.eu; www.comtest.eu
Prodotti e servizi: Camere anecoiche, camere di riverbero, RF schermati stanze e porte, microonde assorbitori

CST Italy Srl

Viale Alcide De Gasperi, 14, I-24047 Treviglio (BG), Italy
+39 0363 3512 42; Fax: +39 0363 3532 11
Emmanuel.Leroux@cst.com; www.cst.com
Prodotti e servizi: Test, antenne, schermatura, cavo, software, spine

E



EM Test AG

Volta S.p.A., Via del Vigneto 23, 39100 Bozen, Italia; +39 0471 56 11 20; Fax: +39 0471 56 11 00; gba@volta.it; www.volta.it
Prodotti e servizi: Innovative test- and measurement-systems für conducted immunity tests, ESD, transients, automotive, harmonics & flicker, AC/DC-sources, safetytest systems, accredited calibrations, seminars, workshops, consulting

EMC Partner

AFJ Instruments Srl, Mr. Marco Mozzi, Via Corno di Cavento 5; IT - 20148 Milano, Italia
+39 02 91434850; Fax: +39 02 91434877
info@afj-instruments.com; www.afj-instruments.com
Prodotti e servizi: Oscillazioni di tensione e sovratensioni temporanee, Strumentazione per test



ETS - Lindgren

Unit 4, Eastman Way, Pin Green Industrial Area, Stevenage, Hertfordshire, SG1 4UH, United Kingdom

+44(0)1438 730700; Fax: +44(0)1438 730750
uk@ets-lindgren.com; www.ets-lindgren.com
Prodotti e servizi: Antenne, Cavi e connettori, Filtri, Stanze e spazi schermati, Schermatura, Strumentazione per test, Test

F



Fair-Rite Products Corp.

Schaffner EMC Srl, Via Galileo Galilei, 471-20092 Cinisello Balsamo (MI), Italia
+39 02 66043045; Fax: +39 02 6123943;
italysales@schaffner.com
Technopartner, Via Delle Imprese, 44/46 Ang Murari, Brembate Sotto 24041, Italia
+39 03 54874010; Fax: +39 03 54826473
marketing@technopartner.it; www.fair-rite.com
Prodotti e servizi: Ferritici, Filtri, Stanze e spazi schermati, Stanze e spazi schermati

Federal-Mogul Corporation

Via Reiss Romoli 122/11, 10148 Torino, Italia
+39 011 22 63 016; Fax: +39 011 22 63 016; systems-protection@federalmogul.com; www.federalmogul.com/sp
Prodotti e servizi: Schermatura; Cavi

Finmotor Srl

Via Edison, 217, 20019 Settimo Milanese, Milano, Italia
+39 02 48910020; Fax: +39 02 48910053
info@finmotor.com; http://finmotor.com
Prodotti e servizi: Filtri

G

Ghiringhelli Mario

Via Luigi Riva, 10 - 21013 Gallarate Varese, Italia
+39 03 31 70 05 25; Fax: +39 03 31 70 05 26;
info@ghiringhellimario.com; www.ghiringhellimario.com
Prodotti e servizi: Schermatura

Gowanda Electronics

Sincron SRL; Via Aldo Moro 55, Gessate (MI), Italia, 20060
+39 02 95384218; Fax: +39 02 95384210
sincron@sincron.it; www.sincron.it
Prodotti e servizi: induttori

H

Haefely EMC Division

Insittec Elettronica S.r.l., Via del parco degli Scout 7, 20091 - Bresso - Milano, Italia
 +39 02 66501075; +39 02 66501096;
 Roberto Landriscina, insittec@insittec.it; www.insittec.it
Prodotti e servizi: Oscillazioni di tensione e sovratensioni temporanee, Strumentazione per test

I



RF/Microwave Amplifiers

IFI - Instruments for Industry

AMETEK CTS GmbH, Lünener Str. 211, 59174 Kamen, Germany; +49 2307 26070-0, Fax: +49 2307 17050, sales.cts@ametek.com, www.ametek-cts.com
Prodotti e servizi: Amplificatori a RF e microonde ad alta potenza (Tetrode Tubes, Solid State and TWT)

Instec Filters

Milano Brothers; Via Enrico Fermi 79, Roma, Italia, 00146 +39 (0) 6888 16531; Fax: +39 (0) 33849 69298
 Uriel Perugia, perugia@milanobro.com; www.milanobro.com.
Prodotti e servizi: Filtri

International Business Development

Via San Rocco, 8/a, 25032 Chieri (BS), Italia
 +39 03 07100618; Fax: +39 03 07002803
 ibd@iol.it; www.ibdonline.it
Prodotti e servizi: Test

L

LP Instruments

Milano: Via Via Leonardo Da Vinci, 255A, 20090 Trezzano sul Naviglio (MI) Italia
 +39 02 48401713; Fax: +39 02 48401852;
 info@lpinstruments.it; www.lpinstruments.it
 Roma: Viale Battista Bardanzellu, 46, 00155 Roma Italia
 +39 06 40800491; Fax: +39 06 40800493
 info@lpinstruments.it; www.lpinstruments.it
Prodotti e servizi: Test

M



RF/Microwave Amplifiers

MILMEGA

Volta S.p.A., Via del Vigneto 23, 39100 Bozen, Italia; +39 0471 56 11 20; Fax: +39 0471 56 11 00; gba@volta.it; www.volta.it
Prodotti e servizi: High Power RF and Microwave solid state amplifiers. Frequency range 80MHz up to 6GHz, with output powers to 1kW

R



Rohde & Schwarz Italia S.p.A.

Via Tiburtina 1095, 00156 Roma, Italia
 +39 (0) 06 415 98.1; Fax +39 (0) 06 415 98 308
 rsi.info@rohde-schwarz.com; www.rohde-schwarz.it
 Web Store: www.rohde-schwarz.it/surf-in
Prodotti e Servizi: EMC Test Equipment e accessori, amplificatori a banda larga, EMC del software di prova, chiavi in mano di test System Solutions

S



Schlegel Electronic Materials

Sirces Srl, Via C. Boncompagni 3/B, 20139 Milano Italia;
 +39 02 55231395; Fax: +39-0256816112; Mario Crippa, mario.crippa@sirces.it; www.sirces.it
Prodotti e servizi: Materiali conduttivi, Schermatura

Soliani EMC SRL

Via Varesina 122, 22100 Como, Italia; +39 03 15001112;
 Fax: +39 03 1505467; info@solianiemc.com;

www.solianiemc.com

Prodotti e servizi: Materiali conduttivi, Stanze e spazi schermati, Schermatura

T

TDK-EPC Italy S.r.l.

Via Mecenate, 90, I-20138 Milan, Italy
 +39-02-5099 54 25
 info@tdkrf.com; www.tdkrfolutions.com
Prodotti e servizi: Antenne, Filtri, Software, Servizi di collaudo

Tech-Etch, Inc.

Sirces Srl, Italia, Via C. Boncompagni 3/B, 20139 Milano - MI, Italia
 +39 02 55231395; Fax: +39 02 56816112
 nicola.iacovino@sirces.it; www.tech-etch.com
Prodotti e servizi: Materiali conduttivi, Schermatura

Technopartner Srl

Via Delle Imprese, 44/46, 24041, Brembate Sotto (BG), Italia
 +39 035 4874010; Fax: +39 035 4826473
 marketing@technopartner.it; www.technopartner.it
Prodotti e servizi: Schermatura

TEMAS Engineering

Via Milano 72, 22070 Bregnano CO, Italia
 +39 031 772348; Fax: +39 031 773897
 info@temas.it; www.temas.it
Prodotti e servizi: Schermatura

A.H. Systems, inc.

 DRG Horns 120 MHz - 40 GHz 8 Models	 Log Periodics 20 MHz - 7 GHz 13 Models	 Preamplifiers 50 MHz - 40 GHz 8 Models	 Low Loss Cables DC - 40 GHz 4 Models
 Biconicals 70 MHz - 330 MHz 5 Models	 BiLogicals 25 MHz - 7 MHz 6 Models	 Monopoles 100 Hz - 50 MHz 6 Models	 Probes 20 Hz - 1 GHz 16 Models
 Standard Gain Horns 1 GHz - 40 GHz 8 Models	 Loops 30 Hz - 20 MHz 7 Models	 H-Field Rods 100 Hz - 30 MHz 4 Models	 Antenna Kits 30 Hz - 40 GHz 16 Models

Represented by



narda
Safety Test Solutions®
an iB Communications Company

TEL: 39 02 269987.02
 FAX: 39 02 269987.00
 http://www.narda-sts.it/
 support@narda-sts.it

TESEO

TEL: 39 011 99.41.911
 FAX: 39 011 99.41.900
 http://www.teseo.net/
 fchinaglia@teseo.net

Italy







A.H. Systems
http://www.AHSystems.com

TESEO S.p.A.

Corso Alexander Fleming, 25/27/29 10040 Druento (TO), Italia; +39 011 9941911; Fax: +39 011 9941900; info@teseo.net; S.Serra@teseo.clemessy.com www.teseo.net
Prodotti e servizi: Test



Advanced Test Solutions for EMC

Teseq Ltd.

Narda Safety Test Solutions S.r.l.

Via Leonardo da Vinci, 2½3, 20090 Segrate, Milano, Italia +39 02 2699871; Fax: +39 02 26998700; roberto.grego@narda-sts.it; www.narda-sts.it
Prodotti e servizi: Amplifiers (RF & Microwave), Antenne, sistemi automotive, Immunità RF, Picco di e transistori, ESD, Armoniche e Flicker, GTEM-celle, sistemi di immunità RF, RF Emission Systems, RF Testsoftware, Taratura e Servizi

W



Würth Elektronik Italia srl

Via Fabio Filzi, 54 IT-20032 Cormano (MI), Italia +39 0266 281710; eiSos-italy@we-online.com
Prodotti e servizi: Ferriti, cavo e spina

RISORSE

IEE EMC SOCIETY ITALIA CHAPTER

Università degli Studi dell'Aquila, Via G. Gronchi 18, 67100, L'Aquila, Italia +39 320-923116, Fax: +39 0862-701979
Chairman Giulio Antonini, g.antonini@iee.org; ing.univaq.it/emc-chap-it

CEI - COMITATO ELETTROTECNICO ITALIANO

Via Saccardo, 9- 20134, Milano, Italia; +02 21006 226 Fax: +02 21006 222
Punto Vendita, puntovendita@ceiweb.it; www.ceiweb.it

MINISTERO DELLO SVILUPPO ECONOMICO

Via Molise 2, 00187 Roma, Italia; +39 06 4705 1; Fax: +39 06 4788 7748; www.sviluppoeconomico.gov.it/index.php



NSG 3040 MULTIFUNCTION GENERATOR – GOOD THINGS COME IN SMALL PACKAGES

Small and smart, the NSG 3040 features a high-contrast 7" touchscreen color display and rotary wheel for quick input with appealing ease of operation. With its open modular architecture, the NSG 3040 is the ideal immunity test system for smaller engineering labs – with amazing capacities for demanding EMC testing companies and for easy integration into the production process. The electromagnetic pulses generated from this multipurpose unit are especially tailored for CE marking requirements and other national and international standards. Like its big brother, NSG 3060 (6.6 kV), the NSG 3040 also has a SD memory card where test files can be saved easily and expanded at any time.

NSG 3040 at a glance:

- Modular, expandable system
- Surge voltage to 4.4 kV
- EFT/Burst to 4.8 kV/1 MHz
- Dip/Interrupt to 16 A/260 VAC & DC
- Easy-to-operate 7" touchscreen color display
- Quickly launch tests from extensive Standards Library or User Test folders
- Parameters can be changed during test

Represented by Narda Safety Test Solutions Segrate
T+39 02 2699871 www.narda-sts.it
www.teseq.com



EXHIBITION - CONFERENCES - ANIMATIONS

4th
edition

Microwave & RF

The Trade show
of radiofrequencies,
microwaves, wireless, EMC
and optical fibre.

April 1 & 2, 2015

**CNIT
Paris la Défense**

www.microwave-rf.com

Organization



Il Primo Approccio Pratico all'EMC Per la Sicurezza Funzionale (Gestione del Rischio EMC)

KEITH ARMSTRONG

President

Cherry Clough Consultants Ltd.

ATTUALMENTE VI SONO numerose norme per la sicurezza funzionale (gestione del rischio) che si applicano ai sistemi elettronici pertinenti, ivi comprese IEC 61508 [1] e gli standard derivati dalla stessa, elencati alla sezione II di [2], e l'ISO 14971 [3].

In tutti i casi sono previsti requisiti per le interferenze elettromagnetiche (EMI), ma è risaputo da lungo tempo che la conformità alle norme in relazione alle prove EMC di immunità ed emissioni è insufficiente per garantire la sicurezza funzionale, anche incrementando i livelli di immunità. Purtroppo, ad oggi non sono state pubblicate norme alternative che forniscano parametri e metodi per valutare se tali requisiti siano stati soddisfatti.

Nel 2008 tutte le guide, i progetti di norme e le specifiche tecniche IEC (ad es. [4] [5]) sulla EMC per la sicurezza funzionale presumevano che se non si utilizzavano i grandi, pesanti e costosi "armadi grigi con schermatura" il problema poteva essere risolto con una progettazione EMC e relativa verifica e convalida pensate in modo intelligente.

Tuttavia, numerose società hanno tentato di mettere in pratica questo "approccio EMC intelligente" che si è rivelato impraticabile per vari motivi (descritti in [2] [6]). Gli scambi di opinioni tra queste società e altri professionisti della sicurezza funzionale hanno portato a un approccio alternativo e pratico basato su "tecniche e misure" di validità comprovata per la progettazione di software e hardware, oltre a una valutazione indipendente.

La conversione del concetto iniziale in un documento che fosse ampiamente condiviso per essere pubblicato da IET [7] ha richiesto una grande mole di lavoro da parte dei professionisti specializzati in EMC e degli esperti di sicurezza funzionale del Gruppo di lavoro IET. Sono stati inoltre tenuti in considerazione oltre 160 commenti di alto livello sulla prima bozza, espressi da una vasta platea di esperti in sicurezza funzionale ed EMC, comprese le autorità per la sicurezza britanniche.

Questo nuovo approccio si articola in tre parti, come indicato in Figura 1.

This article discusses the first practical approach to EMC for functional safety (EMC Risk Management). There are now many standards on Functional Safety (Risk Management) that apply to relevant electronics, including IEC 61508 and the standards developed from it listed in Section II of "Cost-effective Risk Management of EMC without special EMC design expertise or testing," IEEE 2013 Int'l EMC Symposium, Denver, CO, and ISO 14971. They all require that EMI be dealt with, but complying with emissions and immunity EMC test standards, even using increased levels of immunity testing, has long been known to be insufficient for Functional Safety. This article discusses these issues and the new approach. To read this article in English, visit our website www.interferencetechnology.com.



FIGURA 1: Approccio seguito dalla nuova guida IET.



FIGURA 2: Sistema relativo alla sicurezza e relative parti costituenti (nei riquadri gialli).

Eventuali disturbi elettromagnetici inusuali o estremi che superino il livello di protezione ottenuto conformandosi alle norme sulle prove di immunità causano interferenze elettromagnetiche nell'apparecchiatura. Le interferenze elettromagnetiche provocano errori, anomalie o avarie nei segnali dell'apparecchio e/o nell'alimentazione.

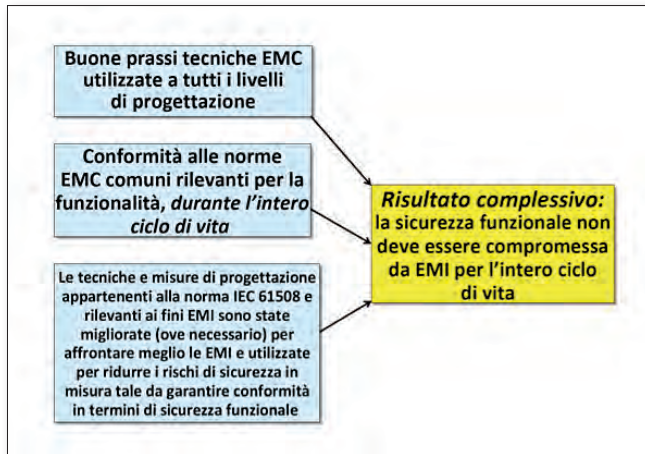
A partire dal 2000 la norma IEC 61508 [1] raccomanda decine di tecniche e misure per la progettazione di sistemi, hardware, software e alimentazione elettrica per la rilevazione e/o la risoluzione di errori, anomalie o avarie che interessano i segnali e l'alimentazione.

Attorno all'utilizzo di tali tecniche e misure è sorta un'industria per garantire la conformità ai requisiti di sicurezza funzionale sia nella progettazione sia nella valutazione indipendente. Tutti gli enti internazionali di certificazione della sicurezza (Intertek, TÜV Rheinland/Nord/Süd, SGS, e molti altri ancora) offrono servizi di valutazione; senza l'approvazione di un perito indipendente non è possibile vendere o installare un nuovo progetto.

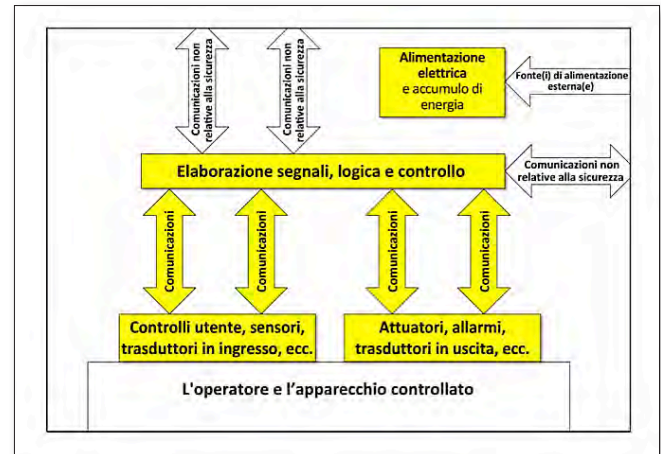
La nuova guida IET raccomanda le tecniche e misure della norma IEC 61508, efficaci soprattutto per le interferenze elettromagnetiche, consigliando in alcuni casi come applicarle per migliorarne l'efficacia.

Per utilizzare la nuova guida IET, gli ingegneri che si occupano di EMC devono progettare e realizzare apparecchi che continuino a essere conformi alle norme per le prove di EMC pertinenti per l'intero ciclo di vita nei rispettivi ambienti reali (non solo quando sono nuovi e in un laboratorio EMC).

Inoltre i progettisti e periti indipendenti che operano nell'ambito della sicurezza funzionale devono applicare le tecniche e misure che già conoscono molto bene in modi leggermente diversi, affinché le interferenze elettromagnetiche non causino rischi inaccettabili durante il ciclo di vita dell'apparecchio.

Le nuove linee guida IET [7] possono essere applicate per completare i sistemi relativi alla sicurezza o loro componenti, come indicato nella Figura 2. Ad esempio, il tradizionale approccio del "grande armadio grigio" può essere usato per alcune parti di un sistema di sicurezza, ricorrendo alle tecniche e misure per altre [7].

RIFERIMENTI

- [1] IEC 61508 Ed.2:2010, "Functional Safety of Electrical/Electronic/Programmable Electronic Safety-Related Systems", pubblicazione IEC sulla sicurezza di base in sette parti.
- [2] Keith Armstrong, "Cost-effective Risk Management of EMC without special EMC design expertise or testing", IEEE 2013 Int'l EMC Symp., Denver, CO, USA, agosto 5-9, 2013, ISBN: 978-1-4799-0409-9
- [3] ISO 14971 "Dispositivi medici: la gestione del rischio applicata ai dispositivi medici"
- [4] IEC TS 61000-1-2, Ed.2.0, 2008-11, "Methodology for the achievement of the functional safety of electrical and electronic equipment with regard to electromagnetic phenomena", pubblicazione IEC sulla sicurezza di base.
- [5] IET, "EMC for Functional Safety", agosto 2008, da www.theiet.org/factfiles/emc/emc-factfile.cfm, o www.emcacademy.org/books.asp
- [6] Keith Armstrong, "The first practical techniques for achieving EMC for Functional Safety (without using big grey boxes)", The EMC Journal, n. 108, settembre 2013, www.theemcjournal.com
- [7] IET, "Overview of techniques and measures related to EMC and Functional Safety", agosto 2013, download gratuito: www.theiet.org/factfiles/emc/emc-overview.cfm.

BIOGRAFIA

Keith Armstrong si è laureato con lode presso l'Imperial College di Londra nel 1972 con una laurea in Ingegneria Elettrica, specializzata nella progettazione di circuiti analogici e teoria del campo elettromagnetico.

Tra il 1972 e il 1990 Keith ha lavorato per diverse aziende di elettronica, come progettista elettronico, poi project manager e design manager.

Nel 1990 si recò indipendente con Cherry Clough Consultants Ltd, che fornisce servizi di progettazione per contribuire a realizzare la conformità con EMC, e con sicurezza, mentre allo stesso tempo contribuendo a ridurre il time-to-market, i costi di progettazione, costi unitari di produzione e costi di garanzia.

ESPAÑA



94 PRODUCTOS Y SERVICIOS

98 LOS RECURSOS

Nueva Banda Dual Clase A Modelos de Amplificadores de Estado Sólido

Desde 700 MHz hasta 18 GHz



AR ahora ofrece un amplificador de estado sólido Clase A en un sólo equipo, cubriendo el más amplio rango de frecuencia. Ahora nuestros diseños de mayor ancho de banda cubren un rango de frecuencia desde 700 MHz hasta 18GHz en configuración de banda dual. Estos amplificadores están disponibles en dos distintas configuraciones de bandas, desde 700 MHz hasta 4.2 GHz y 4 hasta 18 GHz con potencia hasta 80 vatios o desde 700 MHz hasta 6 GHz y 6 a 18 GHz con potencia hasta 50 vatios. Otras bandas de frecuencias desde 700 MHz hasta 8 o 10.6 GHz también están disponibles.

Ahora tienes muchas más opciones. Simplemente elige la potencia que necesitas en cada banda de nuestros 40 modelos disponibles. Construimos nuestros amplificadores de banda dual de menor potencia con flexibilidad con el fin de incrementar los niveles de potencia con posterioridad, dado que tus necesidades cambian constantemente.

Nuestros amplificadores de banda dual pueden ser utilizados para muchas aplicaciones tales como EMC, EW y sustitución de TWTA, porque son lineales, muy fiables, con gran rechazo de armónicos y son extremadamente tolerantes a las cargas. www.ar-europe.ie/dualBand

sales@spantech.es

+34 95 241 7024

ISO 9001:2008
Certified

ar europe

National Technology Park, Ashling Building, Limerick, Ireland • +353 61 504300 • www.ar-europe.ie

In Europe, call ar United Kingdom +44 1908 282766 • ar France +33147917530 • ar Deutschland +49 6101 80270 0 • ar Benelux +31 172 423000

www.arworld.us

Copyright © 2014 AR. The orange stripe on AR products is Reg. U.S. Pat. & TM. Off.



PRODUCTOS Y SERVICIOS

A



A.H. Systems

WAVECONTROL, S.L.

C/Pallars 65-71, Barcelona, ES-08018, España

+34 933 208 055, ext 3; Fax: +34 933 208 056

Raimon Gomez, raimon-gomez@wavecontrol.com

www.wavecontrol.es; www.AHSystems.com

Productos y servicios: Antenas EMI calibradas individualmente, preamplificadores, sondas de corriente

Adler Instrumentos

C/Antonio de Cabezón, 83 2ª planta,

28034 Madrid, España

+34 913 584 046; Fax: +34 913 581 383

info@adler-instrumentos.es; www.adler-instrumentos.es

Productos y servicios: Instrumentación para pruebas

AFJ INSTRUMENTS SRL

WAVECONTROL, S.L.

Pallars, 65-71 Barcelona, 08018 España

+34 933 208 055; Fax: +34 933 208 056

Raimon Gómez, raimon-gomez@wavecontrol.com

www.wavecontrol.es

Productos y servicios: Receptores EMI, LISN, Analizadores de click, accesorios para CISPR 14 y 15, sondas de tensión, limitadores de pulsos, pinzas de absorción, etc.

APPLUS

LGAI Technological Center, S.A. / Catalunya, Campus

UAB Carretera acceso a la Facultad de Medicina, s/n,

Bellaterra 08193, Barcelona, España

+34 93-567 20 00; www.appluscorp.com

Productos y servicios: Pruebas



AR RF/Microwave Instrumentation

Spantech Microwave Technology S.A.

Nave 6, Polígono La Moraga, 29130 Alhaurín

de la Torre, Málaga, Spain; +34-95-241-7024

Desirée Them, sales@spantech.es

Productos y servicios: Amplificadores, Antenas, Cables y conectores, Habitaciones y recintos aislados, Sobrecargas y transitorios, Instrumentación para pruebas

Arrow Europe

Albasanz 75 28037 Madrid, España

+34 91 304 30 40; www.arroweurope.com

Productos y servicios: Ferritas, cables y conectores

AST - Advanced Shielding Technologies

Albert Einstein, 43 E-08940

Cornellà de Llob. (BCN) España

+34 934 751 481; +34 616 081 176; Fax: +34 933 772 880

Jordi Ferri, Shielding Division Manager

info@ast-global.com; http://ast-global.com

Productos y servicios: Aislamiento

B

BONN Elektronik GmbH

WAVECONTROL, S.L.

Pallars, 65-71 Barcelona, E-08018 España

+34 933 208 055; Fax: +34 933 208 056

raimon-gomez@wavecontrol.com; www.wavecontrol.es

Productos y servicios: Amplificadores de potencia de banda ancha.

C

CEMITEC

Polígono Mocholí, Plaza Cein 4, 31110, Noain, España

+34 848 420 800; Fax: +34 948 317 754

info@cemitec.com; www.cemitec.com

Productos y servicios: Pruebas

Alava Ingenieros

Madrid, Spain.

+34-915679720/26; Maxi Herrera

mherrera@alava-ing.es; www.comtest.eu

Productos and servicios: Cámaras anecoicas, cámaras de reverberación, RF blindados salas y puertas, absorbentes de microondas.

D

D.A.R.E.!! Consultancy

WAVECONTROL, S.L.

Pallars, 65-71 Barcelona, 08018 España

+34 933 208 055; Fax: +34 933 208 056

Raimon Gómez, raimon-gomez@wavecontrol.com

www.wavecontrol.es

Productos y servicios: Instrumentación EMC, software EMC, generadores, sondas de campo, medidores de potencia, mástiles y platos giratorios automáticos, accesorios, etc.

Eldonvasa AB

Pº de la Finca, 1 Edificio 13, Madrid 28223, España

+34 953 551 000; Fax: +34 953 551 539

eldon.es@eldon.com; www.eldon.com

Productos y servicios: Habitaciones y recintos aislados

E



EM Test AG

ALAVA Ingenieros S.A., C/ Albasanz 16 - Edificio Antalia,

28037 Madrid; +34 91 567 97 00 Fax: +34 91 570 26 61;

alava@alava-ing.com; www.alava-ing.com

Productos y servicios: Sistemas de Ensayo y Medida innovadores para inmunidad conducida, ESD, Transitorios, Automoción, Armónicos y Flicker, Fuentes AC/DC, seguridad, calibraciones acreditadas, seminarios, workshops, consultoría

EMC Partner AG

WAVECONTROL, S.L.

Pallars, 65 - 71 ES - 08018 Barcelona, España

Raimon Gómez, raimon-gomez@wavecontrol.com

+34933208055; Fax: +34933208056; www.wavecontrol.es

Productos y servicios: generadores impulsionales, ensayos de inmunidad conducida, ESD (descargas electrostáticas), transitorios, ondas oscilatorias, ensayos de rayos para aplicaciones aeronáuticas y militares, ensayos de componentes

ETS Lindgren

WAVECONTROL, S.L.

Pallars, 65-71 Barcelona, E-08018 España

+34 933 208 055; Fax: +34 933 208 056

Raimon Gómez, raimon-gomez@wavecontrol.com

www.wavecontrol.es

Productos y servicios: Cámaras de Faraday y Anecoicas, antenas EMC, sondas de campo, instrumentación EMC.

F



Fair-Rite Products Corp.

Redislogar, Anabel Segura, 11 Centro de Negocios

Albatros, Edificio B28108 - Alcobendas Madrid, España;

+34 902 509 980; Fax: +34 916 591 436

redislogar@redislogar.es; www.fair-rite.com

Productos y servicios: Artículos con ferrita, Filtros, Habitaciones y recintos aislados, Aislamiento

Federal-Mogul Corporation

C/Progres, 394, Barcelona 08918

+34 93 460 24 70; Fax: +34 93 460 18 16

Our expertise takes you to the top. EMC solutions from Rohde & Schwarz.

We provide everything you need for development, precompliance and compliance measurements to ensure successful EMC certification.

- | Exceptionally fast EMI test receivers
- | Efficient diagnostic tools for detecting EMI
- | EMC software packages for interactive and fully automatic measurements
- | Wide range of accessories for performing EMI measurements
- | Compact and modular broadband amplifiers
- | RF shielded chambers
- | Complete EMC test systems

For more information, visit:
www.rohde-schwarz.com/ad/emc



ROHDE & SCHWARZ

systems.protection@federalmogul.com
www.federalmogul.com/sp

Productos y servicios: Conjuntos de cables apantallados y blindados Arneses, Conductos, tuberías blindado

G

GCEM

UPC Campus Nord. Building C4,
c/ Jordi Girona 1-3., 08034, Barcelona, España
+34 934 011 021

info.gcem@upc.edu; www.upc.edu/web/gcem
Productos y servicios: Pruebas

Gowanda Electronics

ACAL BFI Iberia; C/Anabel Segura 7, Planta Acceso,
Alcobendas (Madrid), España, 28108

+34 914531160; Fax: +34 916626837; www.acalbfi.com.
Productos y servicios: Inductores

I

Ibertest International SA

C/ Ramon y Cajal, 35. Pol. Ind Gitesa I,
Daganzo de Arriba, Madrid, 28814, España
+34 91 884 53 85; Fax: +34 91 884 50 02

info@ibertest.es; www.ibertestint.com
Productos y servicios: Pruebas



RF/Microwave Amplifiers

IFI - Instruments for Industry

Adler Instrumentos, S.L., C/Antonio de Cabezon, 83,
28034 Madrid Espana

+34 913 584 046; Fax: +34 913 581 383
www.adler-instrumentos.es

Productos y servicios: Diseñadores y Fabricantes de Amplificadores de Alta Potencia para RF y Microondas (Tetrode Tubes, Solid State and TWT)

INTA

Ctra. Ajalvir, Km. 4 28850,
Torrejón de Ardoz, Madrid, España
+34 915 201 200; www.inta.es

Productos y servicios: Pruebas

ITE

Parque Tecnológico de Valencia, Avenida Juan de la
Cierva 24, 46980 Paterna, Valencia, España

+34 961 366 670; Fax: +34 96 136 66 80
www.ite.es

Productos y servicios: Pruebas

K

Kemtron Ltd.

WAVECONTROL, S.L.

Pallars, 65-71 Barcelona, E-08018 España
+34 933 208 055; Fax: +34 933 208 056

Raimon Gómez; raimon-gomez@wavecontrol.com
www.wavecontrol.es

Productos y servicios: juntas y todo tipo de elementos de apantallamiento.

L

Labien Tecnalia

Parque Tecnológico de Bizkaia, Edificio 700, C/Geldo,
48160, Derio, España

+34 946 073 300; Fax: +34 946 073 349
www.labein.es

Productos y servicios: Pruebas

LACECAL

E.T.S. Ingenieros Industriales, Paseo del Cauce,
59, 47011 Valladolid, España

+34 983 423 343; Fax: 983 423 996
emc@lacecal.es; www.lacecal.es

Productos y servicios: Pruebas

Langer EMV-Technik GmbH

WAVECOTROL S.L.,

Pallars, 65-71 E-08018 Barcelona, España
+34 933 208 055; Fax: +34 933 208 056

Raimon Gómez; raimon-gomez@wavecontrol.com;
www.wavecontrol.es"

Productos y servicios: sondas de campo cercano

LCOE

Laboratorio Central Oficial de Electrotecnia,
c/ José Gutiérrez Abascal, 2, 28006, Madrid, España

+34 915 625 116; Fax: +34 915 618 818
www.ffii.es/lcoe/lcoe_portada.asp

Productos y servicios: Pruebas

Lifasa International Capacitors

c/. Vallès, 32 - Polígono Urvasa, 08130, Santa Perpètua
De Mogoda, Barcelona, España

+34 935 747 017; Fax: +34 935 448 433
info@lifasa.com; www.lifasa.com

Productos y servicios: Filtros

M



RF/Microwave Amplifiers

MILMEGA

Adler Instrumentos, S.L., C/Antonide Cabexon,
83-2, 28034 Madrid, España

+34 91 358 40 46; Fax: +34 91 358 13 83
millan@adler-instrumentos.es

www.adler-instrumentos.es

Productos y servicios: High Power RF and Microwave solid state amplifiers.

Frequency range 80MHz up to 6GHz, with output powers to 1kW

P

Premo Group

Grupo Premo C/. Conchita Supervía, 13 - 08028,
Barcelona, España

+34 934 098 980; Fax: +34 934 906 682
info@grupopremo.com; www.grupopremo.com

A.H. Systems, inc.



DRG Horns
120 MHz - 40 GHz
6 Models



Log Periodics
30 MHz - 7 GHz
23 Models



Preamplifiers
20 MHz - 40 GHz
6 Models



Low Loss Cables
DC - 40 GHz
4 Models



Biconicals
20 MHz - 330 MHz
5 Models



BiLogicals
25 MHz - 7 MHz
6 Models



Monopoles
100 Hz - 50 MHz
5 Models



Probes
30 Hz - 1 GHz
18 Models



Standard Gain Horns
1 GHz - 40 GHz
9 Models



Loops
20 Hz - 30 MHz
7 Models



H-Field Rods
100 Hz - 30 MHz
4 Models



Antenna Kits
30 Hz - 40 GHz
16 Models

Represented by



TEL: +34 93 320 80 55
FAX: +34 93 320 80 56
http://www.wavecontrol.com
info@wavecontrol.com

Spain



A.H. Systems
http://www.AHSystems.com

WAVECONTROL

EMC & RF

Test systems, equipment and components



Wavecontrol, nuevo distribuidor en España de **BONN Elektronik**, la mejor y más amplia gama de amplificadores RF



Cámaras y sistemas



Generadores de pulsos



Amplificadores de potencia



Antenas de ensayo



Sondas de campo



Seguridad eléctrica



Apantallamiento

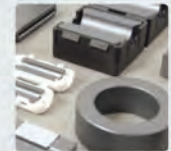

Inductancias Ferritas, etc

RF Safety

Hand-held instruments and monitoring systems

SMP2

FIELD METER

WORKER'S SAFETY
European Directive
2013/35/EU

Unparalleled combination of spectrum analysis and broadband measurements on a single device



1 Hz - 18 GHz
Broadband



LF Spectrum
analysis (FFT)



Weighted
Peak Exposure



R



ROHDE & SCHWARZ

Rohde & Schwarz España, S. A.

C/ Salcedo, 11, 28034 Madrid, España
 +34 (0) 91 334 1070; Fax +34 (0) 91 334 1063
 rses@rohde-schwarz.com; www.rohde-schwarz.es
 Web Store: www.rohde-schwarz.es/surf-in
Productos y Servicios: EMC Equipos de Prueba y Accesorios, amplificadores de banda ancha, EMC Software Test, Test Solutions llave en mano del sistema

S



SCHLEGEL
 electronic materials

Schlegel Electronic Materials

RC Microelectrónica S.A., c/ Francesc Moragas 72, nave 3, 08907 L' Hospitalet de Llobregat, Barcelona España;
 +34 932 602 166; Fax: +34 933 383 602
 Jordi Nogué, Ventas@rcmicro.es; www.rcmicro.es
Productos y servicios: Materiales conductores, Aislamiento

SGS TECNOS

Trespaderne, Edificio Barajas 1,
 28042 Madrid, España
 +34 913 138 000; Fax: +34 913 138 080
 www.sgs.es
Productos y servicios: Pruebas

Salicru S.A.

Avda de la Serra, 100, 08460 Santa María de Palautordera, España
 +34 902 482 400; Fax +34 938 481 151
 salicru@salicru.com; www.salicru.com
Productos y servicios: Filtros

T

Tecnologica

C/ La Majada, 3, 28760, Tres Cantos, Madrid, España
 +34 918 041 893
 www.alter-spain.com
Productos y servicios: Pruebas

T E S E O

Advanced Test Solutions for EMC

Teseq Ltd.

Adler Instrumentos, S.L., C/Antionide Cabexon, 83-2,
 28034 Madrid; España
 +34 91 358 40 46; Fax: +34 91 358 13 83
 millan@adler-instrumentos.es; www.adler-instrumentos.es
Productos y servicios: Amplificadores (RF y Microondas), Antenas, Sistemas Automotrices, de inmunidad conducida RF, sobretensiones conducidas y Transitorios, ESD, Armónicos y Flicker, las células GTEM, Sistemas de Inmunidad a la RF, RF Sistemas de Emisión, Test-software RF, Calibración y Servicio

W

WAVECONTROL

Wavecontrol

Pallars 65-71 Barcelona, E-08018, España
 +34 933 208 055; Fax: +34 933 208 056;
 Raimon Gomez, Raimon-Gomez@wavecontrol.com
 Ernest Cid, ernest-cid@wavecontrol.com;
 www.wavecontrol.es
Productos y servicios: Instrumentación, accesorios y sistemas para EMC, RF, Seguridad Eléctrica y Medida de antenas



Würth Elektronik Spain

Regus Barcelona – Gran Vía de les Corts Catalanes
 583, 5a pl, ES-08011 Barcelona, Spain
 +34 933 063 400; eiSos-spain@we-online.de
Productos y servicios: Cables y Conectores, ferrita

**Amplifiers...
 For Every Application!**

**Solid State
 TWT • Tetrode Tube
 DC - 40 GHz • up to 10 kW**

Represented by Adler-Instrumentos
 Tel: +34 913 584 046 • Fax: +34 913 581 383
 millan@adler-instrumentos.es • www.adler-instrumentos.es

IFI - Instruments For Industry • 903 South Second Street • Ronkonkama, NY 11779
 Tel: +1 631 467 8400 • Fax: +1 631 467 8558 • sales@ifi.com • www.ifi.com

AMETEK®
 COMPLIANCE TEST SOLUTIONS

RF/Microwave Amplifiers

Y

York EMC Services Ltd.

WAVECONTROL, S.L.
Pallars, 65-71 Barcelona, 08018 España
+34 933 208 055; Fax: +34 933 208 056
raimon-gomez@wavecontrol.com; www.wavecontrol.es
Productos y servicios: generadores de ruido de banda ancha, generadores de peine, generadores de armónicos y flicker, para comprobaciones de cámaras de Faraday y set-ups de ensayo

ASSOCIATION**IEEE EMC SOCIETY CHAPTER SPAIN**

Universitat Politècnica de Catalunya, Campus Nord. Edifici C4, C. Jordi Girona 1-3, Barcelona 08034, España
+34 93 401 7826; +34 93 401 1021; Ferran.silva@upc.edu

NOTIFIED BODIES**ALTER TECHNOLOGY GROUP SPAIN C/DE LA MAJADA, Nº 3 28760 TRES CANTOS**

Madrid, España +34 91 8043292
Fax: +34 91 8041664; www.alter-spain.com

APPLUS/LGAI TECHNOLOGICAL CENTER

Campus UAB, Apto Correos 18, 08193 Bellaterra (Barcelona), España +34 935 672 000; Fax: +34 935 672 001' ctc@appluscorp.com; www.appluscorp.com

AT4 WIRELESS CENTRO DE TECNOLOGIA**DE LAS COMUNICACIONES S.A.**

Parque Tecnológico de Andalucía Calle Severo Ochoa, 2, 29590 Campanillas (Málaga), España
+34 952 619100; Fax: +34 952 619112
info@at4wireless.com; www.at4wireless.com

FUNDACION TECNALIA RESEARCH & INNOVATION

Parque Tecnológico de Vizcaya, Ed. 700, 48160 Derio (Vizcaya), España
+34 90 276 00 00; Fax: +34 94 607 33 49
javier.nunez@tecnalia.com; www.tecnalia.com

INSTITUTO NACIONAL DE TECNICA AEROSPAZIAL

Carretera de Ajalvir, km. 4, 28850 Torrejon De Ardoz (Madrid), España
+34 91 5201396; Fax: +34 91 5202021
dejuancr@inta.es

LABORATORIO CENTRAL OFICIAL DE ELECTROTECNIA

Calle José Gutiérrez Abascal, 2, 28006 Madrid, España;
+34 91 5625116; Fax: +34 91 5618818
rguirado@lcoe.etsii.upm.es; www.ffii.es

LABORATORIO ICEM. ASOCIACION ITACA

Universidad Politécnica de Valencia Camino de la Vera, s/n Edificio 8G. Acceso C. Nivel 3 46022, Valencia, España
+34 963879306; Fax: +34 963877279
icem@itaca.upv.es; www.itaca.upv.es

SGS, TECNOS, S.A.

C/ Trespaderne, 29, 28042 Madrid, España
+34 91 3138000; Fax: +34 9131380 90
miguelangel.fernandez@sgs.com



Weekly Newsletter

Subscribe today at www.interferencetechnology.com

interference^{ITEM™}
THE INTERNATIONAL JOURNAL OF
ELECTROMAGNETIC COMPATIBILITY | **technology**

POLSKA



102 PRODUKTY I USŁUGI

104 ZASOBY

106 ARTYKUŁ

Nowiny Cispr-owskie

JAN SROKA, Politechnika Warszawska

Rewolucyjne rozwiązanie pomiaru pola elektromagnetycznego (EM) zasilane laserem



Pomiary modulowanego i CW pola elektromagnetycznego są szybsze, mniej skomplikowane i bardziej dokładne

Nowa seria zasilanych laserem analizatorów pola elektrycznego produkcji AR posiada ekstremalnie wysoką częstość próbkowania i może precyzyjnie mierzyć impulsy pola elektrycznego w zakresie mikrosekund.

Nie znaczy to, że urządzenia są tylko szybkie: to znaczy, że pomiary są dużo bardziej dokładne w porównaniu z pomiarami wykonanymi innymi miernikami pola elektromagnetycznego.

Seria analizatorów pola FA7000 bazuje na innowacyjnym podejściu gdzie wykorzystuje się izotropowe czujniki pola EM do pomiarów składowych tego pola i przesyłania ich amplitud cyfrowo za pomocą światłowodu do procesora.

Reprezentują one całkowicie nową drogę do bardziej dokładnych pomiarów elektrycznego pola modulowanego i pola CW w konwencjonalnych i rewerberacyjnych komorach oraz pozwalają użytkownikowi zobaczyć ewolucję modulacji.

Uzyskano dokładność i szybkość jeszcze niedawno niemożliwą do wyobrażenia. www.ar-europe.ie/fieldAnalyzer

uei_war@uei.com.pl

+48 22 313 17 35

ISO 9001:2008
Certified

ar europe

National Technology Park, Ashling Building, Limerick, Ireland • +353 61 504300 • www.ar-europe.ie

In Europe, call ar United Kingdom +44 1908 282766 • ar France +33147917530 • ar Deutschland +49 6101 80270 0 • ar Benelux +31 172 423000

www.arworld.us

Copyright © 2014 AR. The orange stripe on AR products is Reg. U.S. Pat. & TM. Off.



PRODUKTY i USŁUGI

A



A.H. Systems

AM Technologies Polska SP z o.o., Jerozolimskie 146C,
02-305 Warszawa, Polska
+48 22 532 28 00; Fax: +48 22 532 28 28
info@amt.pl; www.amt.pl; www.AHSystems.com
Produkty i usługi: Anteny, Przyrządy pomiarowe, Testowanie

ABC Elektronik Sp. z o.o.

38-300 Gorlice, ul. Kolejowa 10, Polska
+48 18 35 36 665; Fax: +48 18 35 36 833
info@abcpol.pl; www.abcpol.pl

Produkty i usługi: Anteny, Filtry, Rdzenie ferrytowe, Ekranowanie



AR RF/Microwave Instrumentation

Urządzenia Elektroniczne Import, ul. Kierbedzia 4 pok. 203,
Warszawa, Polska 00-728
+48 22 31 31 735; Fax: +48 22 31 31 736
Dr. inż. Marek Synowiec, uei_war@uei.com.pl; arworld.us
Produkty i usługi: Wzmacniacze, Anteny, Kable i złącza, Ekranowane pomieszczenia i obudowy, Zabezpieczenia przepięciowe i przebiegu przejściowego, Przyrządy pomiarowe

ASTAT

ASTAT Sp. z o.o.

60-451 Poznań, ul. Dąbrowskiego 441, Polska;
Tel: +48 61 848 88 71; Fax: +48 61 848 82 76
emc@astat.com.pl; www.astat.com.pl

Produkty i usługi: Komory i systemy pomiarowe, Pomiary, Szkolenia, Elementy EMI

Arrow Europe

Warszawa - ul. W. Rzymowskiego 53 02-697 Warszawa;
+48 22 55 88 28 2; Fax: +48 22 55 88 28 3; arroweurope.com
Katowice - ul. Ligocka 103 40-568 Katowice
+48 32 416 09 24; www.arroweurope.com
Produkty i usługi: Ferryty, kable i złącza, Aplikacje zasilające

C

AP-Flyer Sp. z o.o.

ul. Alzacka 5, 03-972 Warszawa, Polska
Artur Przygoda; A.przygoda@ap-flyer.pl; www.comtest.eu
www.ap-flyer.pl; emc@ap-flyer.pl
+48 22 613 0487; +48 22 613 0612

Produkty i usługi: Komory i systemy pomiarowe, RF drzwi i pomieszczenia. Aparatura pomiarowa

E



EM TEST Polska

AMETEK CTS GmbH, Lünener Str. 211, 59174 Kamen,
Germany; +49 2307 26070-0, Fax: +49 2307 17050, sales.
cts@ametek.com, www.ametek-cts.com

Produkty i usługi: Zabezpieczenia przepięciowe i przebiegu przejściowego, Przyrządy pomiarowe, Testowanie

EMC Partner

ASTAT sp. zo.o, ul. Dabrowskiego 441, PL - 60 451 Poznan
+48 61 849 80 61; Fax: +48 61 848 82 76;
Grzegorz Urbaniak, g.urbania@astat.com.pl,
mobile: +48 660 515 934; www.astat.com.pl
Produkty i usługi: Zabezpieczenia przepięciowe i przebiegu przejściowego, Przyrządy pomiarowe

F



Fair-Rite Products Corp.

Industrial Electronics, Hauptstr.
71 - 79 D-65760 Eschborn, Polska;
+49 61 96 92 79 00; Fax: +49 6196-927929
w.uhlig@industrialelectronics.de; www.fair-rite.com
Produkty i usługi: Rdzenie ferrytowe, Filtry, Ekranowane pomieszczenia i obudowy, Ekranowanie

I



RF/Microwave Amplifiers

IFI - Instruments for Industry

ASTAT Sp. Z o.o.; ul. Dabrowskiego 441, 60-451 Poznan
+48 (0) 61 848 88 71; Fax: +48 (0) 61 848 82 76
emc@astat.com.pl; www.astat-emc.com.pl
Produkty i usługi: Projektantów i producentów wysokiej mikrofal i wzmacniaczy (rurki Tetroda, Solid State i TWT)

Industrial Electronics

Rudolf-Diesel-Str. 2a D-65719 Hofheim-Wallau
+49 (0) 6122 / 7 26 60-0; Fax: +49 (0) 6122 / 7 26 60-29;
a.keenan@ie4u.de; w.uhlig@ie4u.de; www.ie4u.de
Produkty i usługi: Ferryty, kable i złącza, Aplikacje zasilające

Instytut Logistyki i Magazynowania

ul E. Estkowskiego 6, 61-755 Poznań, Polska
+48 061 85 049 34; Fax: +48 61 85 26 376
la@ilim.poznan.pl; www.ilim.poznan.pl
Produkty i usługi: Testowanie

K



Kemtron

ASTAT sp z o.o, Dabrowskiego 441, 60-451 Poznan, Polska
+48 61 84 88 871; Fax: +48 61 84 88 276
emc@astat-emc.com.pl; www.astat-emc.com.pl
Produkty i usługi: Materiały przewodzące, Ekranowanie, Uszczelka

M

Meratronik S.A.

Ul. Indry Gandhi 19, 02-776 Warszawa,
Mazowieckie, Polska
+48 22 855 34 32; Fax: +48 22 644 25 56
Janusz Rzyško, jrzyško@meratronik.pl
www.meratronik.pl
Produkty i usługi: Przyrządy pomiarowe



RF/Microwave Amplifiers

Milmega

ASTAT Sp. Z o.o.; ul. Dabrowskiego 441, 60-451 Poznan;
+48 (0) 61 848 88 71; Fax: +48 (0) 61 848 82 76
emc@astat.com.pl; www.astat-emc.com.pl
Produkty i usługi: Projektantów i producentów wysokiej mikrofal i Wzmacniacze RF

N

National Institute of Telecommunications

Szachowa 1, 04-894 Warszawa, Polska
+48 22 51 28 100; Fax: +48 22 51 28 625
info@itl.waw.pl; www.itl.waw.pl
Produkty i usługi: Testowanie

O

OMICROM Dacpol Sp. z o.o.

ul. Pulawska 34, 05-500 Piaseczno Polska
+48 22 70 35 230; dacpol@dacpol.com.pl
www.dacpol.com.pl
Produkty i usługi: Wielofunkcyjne zestawy testowe i systemy akwizycji danych

P

Popek Elektronik

ul. Jasminowa 28, 22-400 Zamosc Polska
+48 84 63 94 984; Fax: +48 84 63 94 136
info@popek-elektronik.com; www.popek-elektronik.com
Produkty i usługi: Wzmacniacze

R

Radius Power

Eurocomp Elektronik GmbH
Nöerdlicher Park 17, D-61231 Bad Nauheim Germany
+49 7146 860660 Fax: +49 7146 860662
Mobile: +49 171 3584554
Dieter Kunick; d.kunick@eurocomp.de
Produkty i usługi: EMI/EMC/RFI filtrówac

Radiotechnika Marketing

ul. Fabryczna 20, Pietrzykowice, 55-080 Kały Wrocławskie, Polska
+48 71 32 70 700; Fax: +48 71 32 70 800
office@radiotechnika.com.pl; http://radiotechnika.com.pl
Produkty i usługi: Filtry, Kable i złącza



Rohde & Schwarz Österreich Sp. z o.o.

Przedstawicielstwo w Polsce
00-807 Warszawa, Al. Jerozolimskie 92
+48 (0) 22 337 64 90-98; Fax +48 (0) 22 465 29 65
rs-Polska@rohde-schwarz.com; www.rohde-schwarz.pl
Web Store: www.rohde-schwarz.pl/surf-in
Produkty i Usługi: EMC urządzenia pomiarowe i akceso-

ria, wzmacniacze szerokopasmowe, EMC testów oprogramowania, gotowe rozwiązania systemowe testowe

S



Schlegel Electronic Materials

Domar Mariusz Dowbor Sp.J., ul. Botaniczna 54/56, 04-543 Warsaw Polska;
+48 22 87 21 200; Fax: +48 22 87 21 205;
Jakub Wójcik; domar@domar.waw.pl; www.domar.waw.pl
Produkty i usługi: Materiały przewodzące, Ekranowanie

T



Advanced Test Solutions for EMC

Teseq Ltd.

ASTAT Sp. Z o.o.; ul. Dabrowskiego 441, 60-451 Poznan;
+48 (0) 61 848 88 71; Fax: +48 (0) 61 848 82 76
emc@astat.com.pl; www.astat-emc.com.pl
Produkty i usługi: Wzmacniacze (RF & Microwave), anteny, Automotive Systems, prowadzone odporność RF, przeprowad-

zone przed przepięciami i nieustalonych, ESD, harmonicznyc i migotania, komórki, GTEM Radiowe systemy odporności, RF Emission Systems, RF Testsoftware, kalibracja i serwis

Tespol Sp. z o.o.

ul. Klecinska 125, 54-413 Wrocław, Polska;
+48 71 78 36 360; Fax: +48 71 78 36 361
tespol@tespol.com.pl; www.tespol.com.pl
Produkty i usługi: Przyrządy pomiarowe

W



Würth Elektronik Polska

ul. Ogrodowa 64 m. 1, PL-55040 Bielany Wrocławskie, Polska Kable i złącza, Ferryty
Tel. +48 (0) 71 346 21 74; eiSos-Polska@we-online.com
Produkty i usługi: Kable i złącza, Ferryty

ASSOCIATION

IEEE EMC SOCIETY CHAPTER

Fryderyk Lewicki, Orange Labs, Telekomunikacja Polska S.A. ul. B. Prusa, 9, 50-319 Wrocław, Polska;
+48 71 321 0924; Fax: +48 71 321 0952; fryderyk.lewicki@telekomunikacja.pl

A.H. Systems, inc.

DRG Horns 119 MHz - 40 GHz, 6 Models
Log Periodics 30 MHz - 7 GHz, 22 Models
Preamplifiers 20 MHz - 40 GHz, 3 Models
Low Loss Cables DC - 40 GHz, 4 Models
Biconicals 20 MHz - 120 MHz, 5 Models
BiLogicals 25 MHz - 7 MHz, 5 Models
Monopoles 100 MHz - 40 MHz, 5 Models
Probes 20 Hz - 1 GHz, 16 Models
Standard Gain Horns 1 GHz - 40 GHz, 8 Models
Loops 20 Hz - 20 MHz, 7 Models
H-Field Rods 100 Hz - 20 MHz, 4 Models
Antenna Kits 30 Hz - 40 GHz, 19 Models

Represented by

AM Technologies

TEL: 48 22 532 28 00
FAX: 48 22 532 28 28
http://www.amt.pl/
info@amt.pl

Poland

NOTIFIED BODIES**ELTEST M. JEWTUCH SPOLKA JAWNA**

ul. Ratuszowa 11, 03-450 WARSZAWA, Polska; +48 22 619 39 66; Fax: +48 22 619 39 66; sekretariat@eltest.com.pl; www.eltest.com.pl

INSTYTUT ELEKTROTECHNIKI

ul. Pozaryskiego 28, 04-703 WARSZAWA, Polska; +48 22 812 00 21; Fax: +48 22 615 75 35; iel@iel.waw.pl; www.iel.waw.pl

INSTYTUT LOGISTYKI I MAGAZYNOWANIA

ul. E. Estkowskiego 6, 61-755 POZNAŃ, Polska; +48 61 850 4900; Fax: +48 61 852 63 76; office@ilim.poznan.pl; www.ilim.poznan.pl

INSTYTUT MECHANIZACJI**BUDOWNICTWA I GORNICICTWA SKALNEGO**

ul. Racjonalizacji 6/8, 02-673 Warszawa, Polska; +48 22 843 27 03; Fax: +48 22 843 27 03; imb@imbigs.org.pl; www.imbigs.org.pl

INSTYTUT ZAAWANSOWANYCH**TECHNOLOGII WYTWARZANIA**

Ul. Wroclawska 37 A, 30-011 KRAKOW, Polska; +48 12 63 17 100; Fax: +48 12 63 39 490; ios@ios.krakow.pl; www.iztw.krakow.pl

INSTYTUT TELE- I RADIOTECHNICZNY

ul. Ratuszowa 11, 03-450 Warszawa, Polska; +48 22 619 22 41; Fax: +48 22 619 29 47; itr@itr.org.pl; www.itr.org.pl

JEDNOSTKA OPINIUJACA, ATESTUJACA I CERTYFIKUJACA WYROBY TEST SP. Z O.O.

ul. Wyzwolenia 14, 41-103 Siemianowice Slaskie, Polska; +48 32 73 08 200; Fax: +48 32 73 08 200; sekretariat@joac-test.pl; www.joac-test.pl

OSRODEK BADAN ATESTACJI I CERTYFIKACJI OBAC SP. Z O.O.

ul. Jasna 31, 44-122 Gliwice, Polska; +48 32 239 44 82; Fax: +48 32 239 44 87; biuro@obac.com.pl; obac.com.pl

OSRODEK BADAWCZO-ROZWOJOWY CENTRUM TECHNIKI MORSKIEJ S.A.

ul. Dickmana 62, 81-109 Gdynia, Polska; +48 58 66 65 300; Fax: +48 58 66 65 304; sekretariat@ctm.gdynia.pl; www.ctm.gdynia.pl

OSRODEK BADAWCZO-ROZWOJOWY PREDOM-OBR

ul. Krakowiakow 53, 02-255 Warszawa, Polska; +48 22 846 19 51; Fax: +48 22 846 19 51; obr@predom.com.pl; www.predom.com.pl

POLSKIE CENTRUM BADAN I CERTYFIKACJI S.A.

ul. Klobucka 23A, 02-699 Warszawa, Polska; +48 22 464 52 00; Fax: +48 22 647 12 22; pcbc@pcbc.gov.pl; www.pcbc.gov.pl

POLSKI REJESTR STATKOW S.A.

Al. Gen. Jozefa Hallera 126, 80-416 Gdansk, Polska; +48 58 346 17 00; Fax: +48 58 346 03 92; mailbox@prs.pl; www.prs.pl

PRZEMYSLOWY INSTYTUT AUTOMATYKI I POMIAROW

Al. Jerozolimskie 202, 02-486 Warszawa, Polska; +48 22 8740 164; Fax: +48 22 8740 216; tmissala@piap.pl; www.piap.pl

URZAD DOZORU TECHNICZNEGO

ul. Szczesliwicka 34, 02-353 Warszawa, Polska; +48 22 57 22 101, +48 22 57 22 110; Fax: +48 22 822 72 09, +48 22 57 22 129; udt@udt.gov.pl; www.udt.gov.pl

ZAKLADY BADAN I ATESTACJI "ZETOM" IM. PROF. F. STAUBA W KATOWICACH SP. Z O.O.

ul. Ks. Bpa Herberta Bednorza 17, 40-384 Katowice, Polska; +48 32 256 92 57; Fax: +48 32 256 93 05; zetom@zetomkatowice.com.pl; www.zetomkatowice.com.pl



KOMORY POMIAROWE

projektowanie, instalacja i weryfikacja komór bezodbiciowych, GTEM, rewerberacyjnych, klatek Faraday'a wraz z umową dotyczącą konserwacji i rozbudowy obiektu.

SYSTEMY POMIAROWE

Kompleksowa integracja systemów pomiarowych wraz ze stanowiskiem do badań EMC (emisja, odporność). Całość zarządzana przez odpowiednie oprogramowanie pomiarowe i wsparta wieloetapowym szkoleniem.



SZKOLENIA

Profesjonalne szkolenia, seminaria, wykłady, prezentacje oraz zajęcia praktyczne z zakresu EMC, organizowane przy współpracy z najlepszymi specjalistami z renomowanych instytucji w kraju i za granicą.

ASTAT

KOMPATYBILNOŚĆ ELEKTROMAGNETYCZNA

PROFESJONALIZM I DOŚWIADCZENIE W EMC

ASTAT Sp. z o.o.

ul. Dąbrowskiego 441,
60-451 Poznań
tel.: 61 848 88 71
fax: 61 848 82 76
www.astat.com.pl
e-mail: info@astat.com.pl



ELEMENTY EMI

- uszczelnianie elektromagnetyczne,
- filtry i dławiki,
- absorbery,
- rdzenie ferrytowe.

POMIARY INŻYNIERSKIE

parametrów jakości energii (zgodnie z EN 50160), zaburzeń o częstotliwościach radiowych (RF), automatyczny pomiar poziomu emisji EM w polu bliskim za pomocą skanera, EMC troubleshooting - rozwiązywanie problemów EMC w urządzeniu klienta.



Nowiny CISPR-owskie

JAN SROKA

Profesor

Politechnika Warszawska

S **TRESZCZENIE.** Obiektywność wyników pomiarów w EMC jest kwestią, w której drzemie jeszcze duży potencjał udoskonalania. Grupy robocze CISPR pracują nad tym nieustannie. Obowiązujący dokument CISPR 11 + A1 wydany został w roku 2010. W przygotowaniu jest jego generalna rewizja, która ma wejść w życie w roku 2015. Omawiany w niej obowiązek stosowania cęgów absorbcyjnych, precyzyjne definicje skrajni EUT oraz małego EUT na pewno wpłyną na poprawę powtarzalności pomiarów emisji promieniowanej. Temu na pewno też będzie służyć sposób traktowania dodatkowego przyłącza uziemienia w badaniach emisji przewodzonej, jeśli w dokumencie zostanie wyeliminowana dwuznaczność, która jest ewidentnym niedopatrzeniem.

WSTĘP

Obecnie obowiązujący dokument CISPR 11 + A1 pochodzi z roku 2010 [1]. W przygotowaniu jest już jego generalna rewizja [4]. Przewiduje się, że wejdzie ona w życie w roku 2015. Jest w niej szereg nowych rozwiązań, mających na celu poprawienie powtarzalności wyników pomiarów emisji promieniowanej. Należą do nich:

- wymóg używania cęgów absorbcyjnych,
- zdefiniowanie skrajni EUT,
- ustalenie dotyczące przyłącza uziemienia.

Artykuł ma na celu przybliżyć te wymogi czytelnikom, aby za wczasu przygotować się do ich wdrożenia.

Po wieloletnich dyskusjach na gremiach CISPR zgodzono się, że na wynik badań emisji promieniowanej w komorze w pół bezodbiciowej, w przedziale częstotliwości poniżej 1GHz istotny wpływ ma impedancja asymetryczna przewodów dołączonych do EUT. Dotyczy to zwłaszcza EUT o małych gabarytach, umieszczonych na stole. Dlatego wprowadzono wymóg stosowania cęgów absorbcyjnych Common Mode Absorbing Device CMAD, na wszystkich przewodach: doprowadzających i odprowadzających energię oraz przewodach komunikacyjnych. CMAD ma stabilizować

There is still big improvement potential in reproducibility by EMC testing. CISPR groups permanently work on it. The document CISPR 11 + A1 in act is issued in 2010. It is already in general maintenance revision which will supersede the existing one in 2015. New regulations included in this document such as: mandatory application of the Common Mode Absorbing Devices, precise definitions of the EUT volume and the small EUT surely will improve reproducibility of the radiated emission. The same concerns the treatment of the special earthing terminal by conducted emission if ambiguity, which is evidently an oversight, will be eliminated. To read this article in English, visit our website www.interferencetechnology.com.

impedancję asymetryczną przewodów.

W dokumencie [2] opisano wymagania techniczne dotyczące CMAD. W dokumencie [3] wprowadzono po raz pierwszy wymóg ich stosowania.

Z dokumentu [4] wynika jeszcze jedna funkcja CMAD. Mogą one, choć nie muszą, decydować o wielkości tzw. przestrzeni EUT, lub inaczej skrajni EUT. Konsekwencją wprowadzenia pojęcia przestrzeni EUT jest inny sposób rozumienia odległości anteny pomiarowej od EUT.

Pojęcie małych EUT które mogą być badane w komorach z trzy-metrowym stanowiskiem pomiarowym zostało wprowadzone już w dokumencie [1]. Dopiero jednak precyzyjne określenie w dokumencie [4] skrajni EUT nie pozostawia wątpliwości interpretacyjnych tego pojęcia.

W wielu przypadkach EUT mają dodatkowe przyłącze uziemienia, niezależnie od żyły uziemiającej PE w przewodzie zasilającym. Dotyczy to zwłaszcza EUT o dużych mocach i gabarytach, w zastosowaniach przemysłowych. W dotychczasowych dokumentach nie było wytycznych jak to przyłącze traktować, co prowadziło do różnorodnych praktyk stosowanych w laboratoriach. Dokument [4] kończy tę dowolność w przypadku emisji promieniowanej, choć w przypadku pomiarów emisji przewodzonej nadal pozostaje dwuznaczność.

h = 30 mm	ZC = 204 Ω
h = 65 mm	ZC = 248 Ω
h = 90 mm	ZC = 270 Ω

Tabela 1. Typowe wartości impedancji charakterystycznej przewodów.

CĘGI ABSORBUJĄCE ZABURZENIA ASYMETRYCZNE CMAD

Zgodnie z dokumentem [2] współczynnik odbicia S11 CMAD musi zawierać się między liniami (czerwone linie na Rys. 1):

- górna, ciągła: przybierająca wartość 0,75 dla 30 MHz opadająca liniowo z logarytmem częstotliwości do wartości 0,55 przy 200 MHz
- dolna, przerywana: przybierająca wartość 0,6 dla 30MHz opadająca liniowo z logarytmem częstotliwości do wartości 0,4 przy 200MHz.

Współczynnik transmisji S21 musi być mniejszy niż 0,25 w całym przedziale częstotliwości (linia niebieska na Rys. 1). Współczynniki te odniesione są do impedancji charakterystycznej ZC przewodu kołowego o średnicy d, umieszczonego na wysokości h nad idealnie przewodzącą

THE BEST EMC-TEST-EQUIPMENT
FOR ANY APPLICATION:

emtest
the benchmark for emc

Automotive + Telecom +
Consumer Products + Military +
Industrial + Medical + Avionics



Your **direct** line to EM TEST Polska is **+48 (0) 518 643 512**

AMETEK[®]

Poland
EM TEST Polska > ul. Ogrodowa 31/35 > 00-893 Warszawa (PL)
> Fax + 48 518 643 512 > E-mail infopolska.emtest@ametek.com

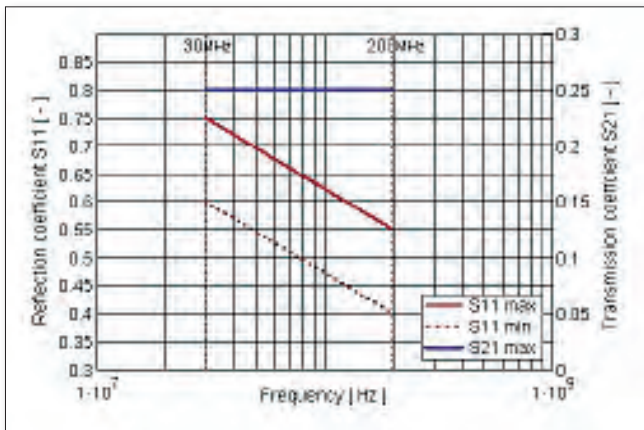

Rys.1. Dopuszczalne wartości parametrów rozproseniowych cęgów absorbcyjnych.

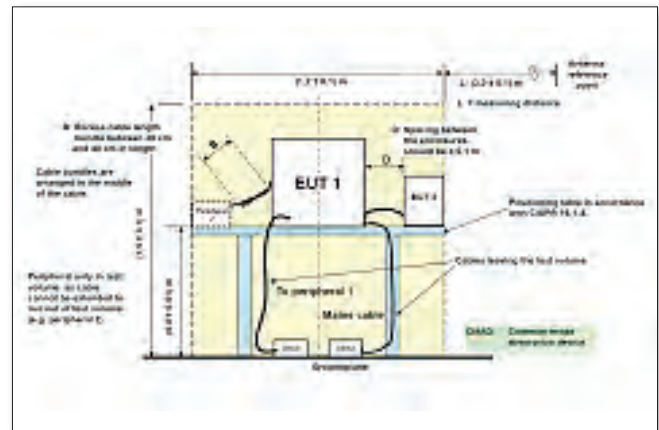

Rys.2. Stanowisko pomiarowe dla urządzeń stojących z [4].

płaszczyzną odniesienia. Wyraża się ona wzorem

$$(1) Z_c = \frac{Z_0}{2 \cdot \pi} \operatorname{ar} \cosh \left(\frac{2 \cdot h}{d} \right)$$

przy czym: Z_0 – impedancja falowa próżni, h – wysokość osi przewodu nad płaszczyzną masy odniesienia, d – średnica obrysu przewodu (typowa wartość $d=4$ mm). Wysokość h wynika z wielkości cęgów, a konkretnie z wysokości osi otworu, w którym umieszczany jest przewód. Wartości impedancji Z_c dla typowych cęgów przedstawione są w Tabeli 1.

Asymetryczna impedancja przewodu umieszczonego w CMAD, widziana od strony EUT wyraża się wzorem [5]

$$(2) Z_1 = \frac{(1 + S_{11} \Gamma_L) \cdot (1 - S_{22} \Gamma_L) + S_{12} \Gamma_L S_{21}}{(1 - S_{11} \Gamma_L) \cdot (1 - S_{22} \Gamma_L) - S_{12} \Gamma_L S_{21}} \cdot Z_C$$

przy czym: Γ_L – współczynnik odbicia za cęgami, patrząc od strony EUT, wynikający z niedopasowania impedancji przewodu do impedancji charakterystycznej Z_C .

Dla pomijalnie małych współczynników transmisji S_{12} i S_{21} wzór ten upraszcza się do postaci

$$(3) Z_1 = \frac{1 + S_{11} \Gamma_L}{1 - S_{11} \Gamma_L} \cdot Z_C$$

Z analizy wzorów (2) i (3) wynika wniosek, że potrzebne są oba wymogi dotyczące CMAD. Parametr S_{11} zapewnia pożądaną wartość impedancji przewodu, natomiast małe wartości parametrów $S_{21} = S_{12}$ zapewniają brak wrażliwości impedancji Z_1 na impedancję przewodu za cęgami, patrząc od strony EUT.

Ani dodatkowe cęgi, używane w pomiarze emisji mocy zgodnie z dokumentem CISPR 16-1-3, zwane tam Secondary Absorbing Device SAD, ani cęgi odsprężające zalecane w normie EN 61000-4-6 nie spełniają wymogów narzuconych na CMAD. Dla laboratoriów badawczych oznacza to nowy zakup.

Stanowisko w pomiarach emisji promieniowanej w przedziale do 1GHz.

Dokument [4] narzuca obowiązek stosowania CMAD w pomiarach emisji promieniowanej w przedziale do 1GHz. Pomiar ten przeprowadza się na podłodze obrotowej. Obracające się EUT wyznacza swoimi skrajnymi elementami cylinder, któremu w dokumencie [4] nadaje się nazwę objętości EUT. Powierzchnia tego cylindra (boczna i podstaw) jest skrajnią EUT. Przykład stanowiska pomiarowego dla urządzenia pracującego na stole z możliwym okablowaniem, zgodnie z dokumentem [4] przedstawiono na Rys. 2, natomiast dla urządzenia pracującego na podłodze na Rys. 3. Na Rys. 3 widać, że usytuowanie CMAD może decydować o skrajni EUT.

Dokument [4] jest pierwszym dokumentem, który precyzuje pojęcie odległości anteny od EUT.

Odległość ta jest jednoznacznie określona pomiędzy punktem odniesienia anteny logarytmiczno-periodycznej (phase centre [5]), a powierzchnią boczną walca, będącego skrajnią EUT (odległość L na Rys. 4). Ma to następujące konsekwencje dla stanowiska pomiarowego:

- określenie stanowiska pomiarowego jako trzy-metrowego lub dziesięcio-metrowego przestaje wystarczać do scharakteryzowania możliwości pomiarowych komory. Potrzebna jest dodatkowa informacja o maksymalnej objętości EUT, którą można mierzyć. Dla tej objętości komora musi spełniać wymagania narzucone na znormalizowane tłumienie środowiska Normalized Site Attenuation NSA [6]. Zwykle jest to średnica równa lub mniejsza od średnicy podłogi obrotowej.
- Usytuowanie anteny w komorze przestaje być stałe. Zmienia się wraz ze średnicą skrajni EUT.

UZIEMIENIE EUT

Dokument [4] jest pierwszym, w którym wprowadzono pojęcie specjalnego przyłącza uziemienia special earthing terminal (rozdział 8.1, 8.2, Rys. 3). Jeżeli EUT w

¹Doświadczenia autora w pracy w laboratorium badawczym potwierdzają tęzę.

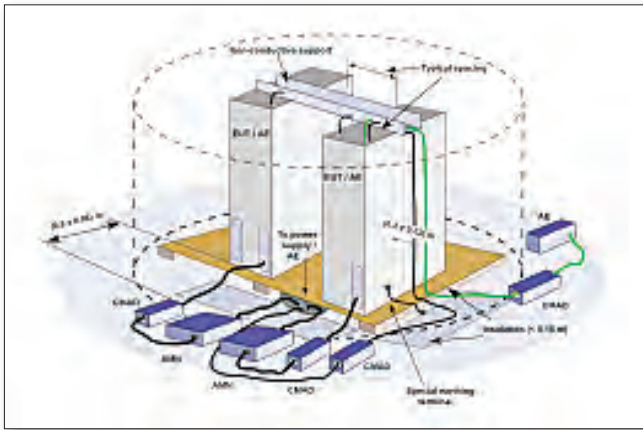

Rys.3. Stanowisko pomiarowe dla urządzeń podłogowych z [4].

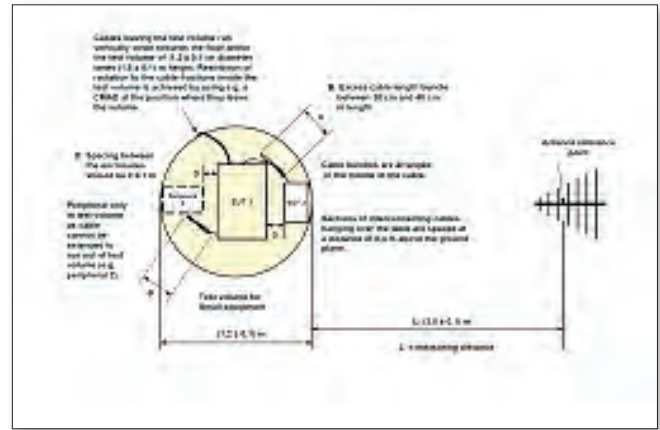

Rys.4. Stanowisko pomiarowe wraz z anteną z [4].

warunkach normalnej eksploatacji musi mieć dodatkowe uziemienie, oprócz żyły PE w przewodzie zasilającym, to w trakcie pomiarów emisji promieniowanej i przewodzonej przyłączyć to ma być połączone z masą odniesienia możliwie krótkim i niskiindukcyjnym przewodem.

Problem polega na tym, że w tym samym dokumencie, w rozdziale 7.5.3.2, w którym opisane jest stanowisko pomiarowe do pomiarów emisji przewodzonej mówi się o:

- przyłączy uziemienia dla celów bezpieczeństwa,
- innym przyłączy uziemienia np. dla celów EMC.

W odniesieniu do tych uziemień wymaga się, aby były one podłączone do punktu uziemiającego sieci sztucznej przewodem o takiej samej długości co przewód zasilający, prowadzonym równolegle z nim.

WNIOSKI

Przygotowywany dokument [4] wprowadza wiele nowych rozwiązań precyzujących stanowisko pomiarowe do badań emisji promieniowanej. Na pewno poprawi to obiektywność wyników pomiarów.

Wprawdzie dokument [1] określa kryterium umożliwiające badanie EUT na trzy-metrowym stanowisku pomiarowym. Jest to możliwe dla małych EUT. Jednak dopiero wprowadzone w dokumencie [4] pojęcia skrajni EUT nie pozostawia wątpliwości interpretacyjnych tego pojęcia. Kończy to definitywnie dotychczasową praktykę nadużywanie małych komór trzy-metrowych do pomiarów nie małych EUT. Ponadto pojęcie skrajni EUT różnicuje możliwości stosowania komór, również dziesięcio-metrowych ze względu na przestrzeń ze zweryfikowanym NSA.

Dokument [4] podaje dwa wykluczające się sposoby traktowania przyłącza uziemienia w trakcie badań emisji przewodzonej. Jest to ewidentne niedopatrzenie, które może mieć znaczny wpływ na wyniki pomiarów. Miejmy nadzieję, że narodowe komitety CISPR dostrzegą to i spowodują jego korektę.

LITERATURA

- [1] CISPR 11 + A1: Industrial, scientific and medical equipment – Radio frequency disturbance characteristics – Limits and methods of measurement: 2010.
- [2] CISPR 16-1-4: Specification for radio disturbance and immunity measuring apparatus and methods - Part 1-4: Radio disturbance and immunity measuring apparatus - Antennas and test sites for radiated disturbance measurements. 2010.
- [3] CISPR 16-2-3: Specification for radio disturbance and immunity measuring apparatus and methods - Part 2-3: Methods of measurement of disturbances and immunity - Radiated disturbance measurements. 2010.
- [4] CISPR/B/598/CDV: Industrial, scientific and medical equipment – Radio frequency disturbance characteristics – Limits and methods of measurement: 2014.
- [5] Jan Sroka: Niepewność pomiarowa w badaniach EMC, pomiary emisyjności radioelektrycznej OWPW, Warszawa, 2009.
- [6] Jan Sroka: $|\Delta NSASAC| > 4dB$. - co dalej? Przegląd Elektrotechniczny R. 90 NR 7/2014, ss. 14 -17, 2014.

AUTOR

Prof. dr hab. inż. Jan Sroka jest pracownikiem Politechniki Warszawskiej, IETiSIP, Koszykowa 75, 00-662 Warszawa, e-mail: J.Sroka@iem.pw.edu.pl oraz EMC-Testcenter AG, Moosäckerstr. 77, CH-8105 Regensdorf, Szwajcaria, e-mail: jsroka@emc-testcenter.com.

Jest równocześnie doradcą w zakresie kompatybilności elektromagnetycznej firmy ASTAT Sp. z o. o. Poznań, www.astat.com.pl.

NEDERLAND



112 **PRODUCTEN EN SERVICES**

114 **MIDDELEN**

116 **AETIKEL**

Zaaien en Oogsten
MART COENEN, EMC/MCC

Uitvinden Blijft Een Kunst

Van **700 MHz** tot **6 GHz** in één versterker zonder band-omschakeling
als aanvulling op de bestaande 4 tot 18 GHz modellen



Uitgangsvermogen tot 200 Watt CW

De nieuwe familie solid state Hybride Power Modules (HPM's) en versterkers van AR bieden niet alleen waar voor hun geld in een compacte behuizing, maar vallen in het bijzonder op door de prestaties die zij leveren.

Naast onze solid state 4 - 18 GHz modules en versterkers, introduceren wij nu een serie hoog vermogen versterkers die het gehele frequentiebereik van 700 MHz tot 6 GHz in één keer bestrijken. Onze modules leveren uitgangsvermogens tot maximaal 30 Watt CW in een klasse A configuratie en tot 50 Watt in klasse AB.

De klasse A 19" rack modellen zijn verkrijgbaar als complete zelfstandige luchtgekoelde systemen met uitgangsvermogens tot 200 Watt CW met de volgende functionaliteit:

- 0 dBm ingangsevoeligheid
- geïntegreerde voeding
- digitaal bedieningspaneel
- vermogensregeling
- geïntegreerde software
- RF-ingangsbescherming

Zowel de Klasse A-modules als de benchtop modellen hebben een zeer vlakke uitgangskarakteristiek, een laag ruisgetal en kunnen een oneindige uitgangs-mismatch probleemloos overleven. Toepassingen voor deze high performance versterkers zijn legio, zoals Jammers, Radars, ECM, ECCM, Data Links, EMC, Wireless, TWTA vervangers/drivers en communicatie. www.ar-europe.ie/stateOfTheArt

arbeneluxinfo@arworld.us

+31 172 423000

ISO 9001:2008
Certified



ar europe

National Technology Park, Ashling Building, Limerick, Ireland • +353 61 504300 • www.ar-europe.ie

In Europe, call ar United Kingdom +44 1908 282766 • ar France +33147917530 • ar Deutschland +49 6101 80270 0 • ar Benelux +31 172 423000

www.arworld.us

Copyright © 2014 AR. The orange stripe on AR products is Reg. U.S. Pat. & TM. Off.

PRODUCTEN EN SERVICES

A



A.H. Systems, Inc.

EEMCCOIMEX, Apolloweg 80,
8239 Da Lelystad, Nederland
+31 320 295 395; Fax: +31 320 413 133
info@eemc.nl; www.eemccoimex.nl;
www.AHSystems.com

Producten en services: Antennes, Testinstrumenten, Testen

Acal Nederland bv

Eindhoven Airport, Beatrix de Rijkweg12, 5657EG
Eindhoven, Nederland
+31(0)40 250 7400; Fax: +31(0)40 250 7409
sales@acaltechnology.nl; www.acaltechnology.com

Producten en services: Ferrieten, Filters

Accelonix bv

Postbus 7044, NL-5605 JA Eindhoven, Nederland;
+31(0)40 750 1651
sales@accelonix.nl; www.accelonix.nl

Producten en services: Versterkers, Antennes, Filters, Testen



AR Benelux bv

Frankrijklaan 7, ITC Boskoop, NL-2391 PX,
Hazerswoude-Dorp, Nederland
+31(0)17 242 3000; Fax: +31(0)17 242 3009
Stuart Mulhall, arbeneluxinfo@arworld.us;
www.arbenelux.com

Producten en services: Versterkers, Antennes, Spanning en overgangen, Testinstrumenten

Arrow Europe

Eizenkade 3 3992 AD Houten, Nederland
+31 (0) 30 6 39 12 34; www.arroweurope.com
Producten en services: Ferrieten, Kabels & Connectoren, Vermogen Toepassingen

B

Bal Seal Engineering Europe bv

Jollemanhof 16, 5th floor
1019 GW Amsterdam, Nederland
+31-20-638-65-23; Fax: +31-20-625-60-18
W. Young; wyoung@balseal.com;
www.balseal.com

Products and Services: Shielding

Bicon Laboratories

Waterdijk 3a, 5705 CW Helmond, Nederland
+31(0)49 239 0911; Fax: +31(0)49 239 0433
bicon@bicon.nl; www.bicon.nl

Producten en services: Consultants, Testen

C

Carlisle Interconnect Technologies

United Kingdom; +44-7817-731-000
Andy Bowne, Andy.Bowne@carlisleit.com
www.CarlisleIT.com

Producten en services: Filtres

CE-Test

CE-Test, Qualified Testing bv, Kiotoweg 363, 3047
BG Rotterdam, Nederland
+31(0)10 415 2426; Fax +31(0)10 415 4953
cetest@cetest.nl; www.cetest.nl

Producten en services: Testen

CN Rood bv

C.N. Rood B.V., Blauw-roodlaan 280,
2718 SK Zoetermeer, Nederland
+31(0)79 360 0018; Fax +31(0)79 362 8190
info.netherlands@cnrood.com; www.cnrood.com

Producten en services: Testinstrumenten

Comtest Engineering

Industrieweg 12, 2382NV Zoeterwoude, Nederland
+31(0)71 541 7531; Fax +31(0)71 542 0375
info@comtest.eu; www.comtestnl.com

Producten en services: Anechoic chambers, Reverberation chambers, RF shielded rooms & doors, microwave absorbers

CPI International Europe

PO Box 2704, 1000CS Amsterdam, Nederland
+31(0)20 638 0597; Fax: +31(0)20 420 2836
GovaertW@cpiinternational.com
www.cpiinternational.com

Producten en services: Testinstrumenten

D

D.A.R.E.!! Consultancy

Vijzelmolenlaan 7, 3447 GX Woerden, Nederland
+31(0)34 843 0979; Fax: +31(0)34 843 0645
consultancy@dare.nl; www.dare.nl

Producten en services: Testinstrumenten

utch Microwave Absorber Solutions

Industrieweg 12, Zoeterwoude, 2382 NV NL
+31-71-5012526
Bas de Groot; BkdeGroot@dmass.eu; www.dmass.eu
Producten en services: EMC Hybrid and Microwave absorbers

E

EEMCCOIMEX

Apolloweg 80, 8239 Da Lelystad, Nederland
+31(0)32 029 5395; Fax: +31(0)32 041 3133
info@eemc.nl; www.eemc.nl

Producten en services: Afdichtingen, afschermmen, geleidende materialen, filters, ferrieten, versterkers, antennes, test apparatuur en afgeschermdde ruimtes



EM Test GmbH

Accelonix BV, Postbus 7044, 5605 JA Eindhoven, Netherlands; +31 40 750 1650; Fax: +31 40 293 0722; sales@accelonix.nl; www.accelonix.nl
Producten en services: Innovative test- and measurement systems for conducted immunity tests, ESD, transients, automotive, harmonics & flicker, AC/DC-sources, safetytest systems, accredited calibrations, seminars, workshops, consulting

EMC Partner

Rimarck, Mr. Jan Heeroms, Oosterleek 3, NL - 1609 GA Oosterleek Nederland
 +31(0)22 950 3478; Fax: +31(0)22 950 3479
 info@rimarck.nl; www.rimarck.nl
 Producten en services: Spanning en overgangen, Testinstrumenten



EMCMCC

Sedanlaan 13a, 5627MS Eindhoven, Nederland
 +31 6 53811267; Fax: +31(0)40 292 7481
 Mart Coenen; mart.coenen@emcmcc.nl; emcmcc.nl
 Producten en services: Testen, Consultants

European Test Services

Keplerlaan 1, PO Box 299, Noordwijk, 2200 AG, Nederland
 +31(0)71 565 5969; Fax: +31(0)71 565 5659
 www.european-test-services.net
 Producten en services: Testen

F



Fair-Rite Products Corp.

HF Technology, Atalanta 5 1562 LC Krommenie Holland, Nederland
 (0031) (0)75 - 628 37 17; (0031) (0)75 - 621 11 20
 info@hftechnology.nl; www.fair-rite.com
 Producten en services: Ferrieten, Filters, Afgeschermdde ruimtes en afsluitingen, Afscherming

G

Gowanda Electronics

ACAL BFI Nederland bv; Luchthavenweg 53, 5657 EA Eindhoven, Nederland
 + 31 40 2507 400; + 31 40 2507 409
 sales@acalbfi.nl; www.acalbfi.nl
 Producten en services: Inductoren

H

Holland Shielding Systems

Jacobus Lipsweg 124, 3316BP Dordrechf, Nederland
 +31(0)78 613 1366; Fax: +31(0)78 614 9585
 info@hollandshielding.com; www.hollandshielding.com
 Producten en services: Geleidende materialen, Filters, Afgeschermdde ruimtes en afsluitingen, Afscherming, Testen



RF/Microwave Amplifiers

IFI - Instruments for Industry

AMETEK CTS GmbH, Lünener Str. 211, 59174 Kamen, Germany; + 49 2307 26070-0, Fax: +49 2307 17050, sales.cts@ametek.com, www.ametek-cts.com
 Producten en services: High Power Microwave and RF Amplifiers (Tetrode Tubes, Solid State and TWT) up to 40 GHz

M



RF/Microwave Amplifiers

MILMEGA

Accelonix BV, Croy 7, 5653 LC Eindhoven, +31 40

750 1650; Fax: +31 40 293 0722; sales@accelonix.nl; www.accelonix.nl
 Producten en services: High Power RF and Microwave solid state amplifiers. Frequency range 80MHz up to 6GHz, with output powers to 1kW

N



Nexio

EEMC Coimex, Apolloweg 808239 Da Lelystad, Nederland
 +31(0)32 029 5395; Fax : +31(0)32 041 3133
 info@eemc.nl; www.eemc.nl/eng
 Producten en services: Testinstrumenten

P

Philips Applied Technologies EMC

High Tech Campus 26, 5656 AE Eindhoven, Nederland
 +31(0)40 274 6214; Fax: +31(0)40 274 2224
 www.innovationservices.philips.com/contact-us
 Producten en services: Testen

A.H. Systems, inc.



Represented by



TEL: 31 320 295 395
 FAX: 31 320 413 133
 http://www.eemccoimex.nl
 info@eemc.nl

Belgium Luxembourg Netherlands



R



Radius Power

Eurocomp Elektronik GmbH
Nöerdlicher Park 17 , D-61231 Bad Nauheim,
Deutschland
+49 7146 860660 Fax: +49 7146 860662; +49 171
3584554
Dieter Kunick; d.kunick@eurocomp.de
Producten en services: EMI/EMC/RFI filteren



Rohde & Schwarz Nederland bv

Perkinsbaan 1, 3439 ND Nieuwegein, Nederland
+31 (0) 30 60017-00; Fax: +31 (0) 30 60017-99
info.nl@rohde-schwarz.com,
www.rohde-schwarz.nl

Web Store: www.testenmeetwinkel.nl
Producten en Services: EMC Test Equipment en accessoires, breedband versterkers, Test Software, Turnkey Test System Solutions

S



Schlegel Electronic Materials

SHIELDINX
De Ploegschaar 135, 5056 MC Berkel-Enschot,
Netherlands
Tel: +31-6-12049820
Paul Jansen, paul.jansen@shieldinx.com
Producten en services: Geleidende materialen, Testen

T

Tech-Etch, Inc.

HF Technology, Atalanta 5,
1562 LC Krommenie, Nederland
31 75-628 37 17; Fax: 31 75-621 11 20
info@hftechnology.nl; www.tech-etch.com
Producten en services: Geleidende materialen, Afscherming



Advanced Test Solutions for EMC

Teseq Ltd.

Accelonix BV, Croy 7, 5653 LC Eindhoven, Nederland
+31 40 750 1650; Fax: +31 40 293 0722
sales@accelonix.nl; www.accelonix.nl
Producten en services: Versterkers (RF & Microwave), Antennes, Automotive Systems, Geleide RF immuniteit, geleide Surge & transiënten, ESD, harmonischen en Flicker, GTEM cellen, RF immuniteit Systems, RF Emissie Systems, RF testsoftware, Kalibratie & Service

Thales Nederland bv

Vieugelboot 32b, NL-3991 CL Houten, Nederland
+31 (0) 88 499 9900
info@nl.thalesgroup.com; www.thalesgroup.com
Producten en services: Testen

W

Würth Elektronik Nederland

Het Sterrenbeeld 35, NL-5215 MK's-Hertogenbosch, Nederland
Tel. +31 (0) 73 629 1570; eiSos-netherlands@we-online.com
Producten en services: EMC-, nductieve- en elektromechanische-oplossingen

ASSOCIATION

DUTCH EMC-ESD SOCIETY

Postbus 366, 3830 AK Leusden, Nederland
033 465 75 07, Fax: +33 461 66 38, www.emvt.nl, Leusden, Paul Petersen, p.petersen@fhi.nl; emc-esd@fhi.nl

IEEE EMC SOCIETY CHAPTER BENELUX

Frank Leferink, Thales Nederland B.V., P.O. Box 42, 7550 GD, Hengelo, Nederland
+31 74-248-3132; Fax: +31 74-248-4037
leferink@ieee.org

NEDERLANDSE EMC-ESD VERENIGING

Postbus 366, 3830 AK Leusden, Nederland
033 - 465 75 07; Fax: +33 - 461 66 38;
Bezoekadres, Dodeweg 6, gebouw B, 3832 RC Leusden, Nederland
Paul Petersen, p.petersen@fhi.nl

OTHER

AGENTSCHAP TELECOM

Emmasingel 1, 9700 Al Groningen, Nederland
+31 5 050 587 74 44; Fax: +31 50 587 7400
Jean Paul van Assche, jean-paul.vassche@at-ez.nl info@agentschaptelecom.nl

NOTIFIED BODIES

D.A.R.E.!! CONSULTANCY

Vijzelmolenlaan 7, NL-3447 GX Woerden, Nederland
+31(0)348 430 979; Fax: +31(0)348 430 645
consultancy@dare.nl; www.dare.nl

DEKRA CERTIFICATION bv

Utrechtseweg 310, Postbus 5185, 6802 Ed Arnhem, Nederland
+31:(0)26:356 20 00; Fax: +31:(0)26:352 58 00
customer@dekra.com; www.dekra-certification.com

KIWA NEDERLAND bv

Wilmersdorf, 50 (PO Box 137, 7300 AC), 7327 AC Apeldoorn, Nederland
+31 55 539 33 55; Fax : +31 55 539 36 85
gas@kiwa.nl; www.kiwa.nl/netherlands

TELEFICATION bv

Edisonstraat 12A, 6902 PK Zevenaar, Nederland
+31 316 583 180; Fax: +31 316 583 189
info@telefication.com; www.telefication.com

THALES NEDERLAND bv

Surface Radar, Environmental Competence Centre P.O. Box 42, 7550 GD Hengelo, Nederland
+31 74 2488111; Fax: + 31 74 2425936
info@nl.thalesgroup.com; www.thales-nederland.nl

TÜV RHEINLAND EPS bv

Eiberkamp 10, 9351 VT Leek; Postbus 37, 9350 AA Leek, Nederland +31 594 505005;
Fax: +31 594 504804
info@tuv-eps.com; www.tuv-eps.com



Follow Us on Facebook

MILMEGA

Introduces their range of Solid State Amplifier kits & modules

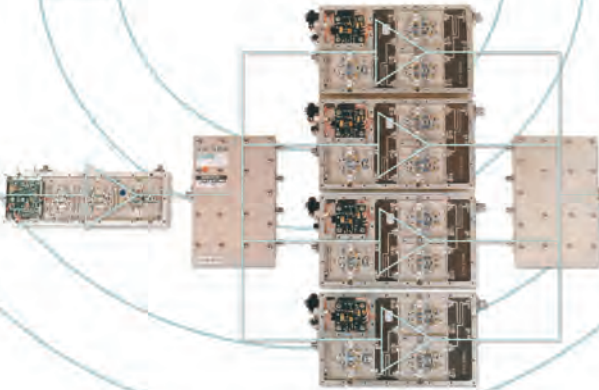

High reliability combined with compact size and low weight also make the family suitable for use in commercial applications where space is at a premium and portability can be used to advantage.

- Available in a range of bandwidths from 800MHz - 6GHz with power outputs from 1W - 230W
- Class Leading Linearity and Noise Specifications
- Customised to suit your power needs
- Backed by the MILMEGA fully expensed warranty



We promise only what we can deliver...
then deliver more than we promise

AMETEK[®]
COMPLIANCE TEST SOLUTIONS

Designers and Manufacturers
of High Power Microwave
and RF Amplifiers



RF/Microwave Amplifiers

MILMEGA Limited Park Road, Ryde, Isle of Wight, PO33 2BE United Kingdom
Tel. +44 (0) 1983 618004 Fax. +44 (0) 1983 811521 sales@milmega.co.uk www.milmega.co.uk

Zaaien en Oogsten

MART COENEN

Owner
EMCMCC

Al vele jaren zijn er nationale en internationale normen en standaarden opgesteld om het apparaat- en productontwerp en fabricage hiervan gemakkelijker te maken of op zijn minst gedefinieerd, binnen de perken te houden. In de meeste gevallen is er zelfs een life-cycle proces voor de normen en standaarden. Oude normen verdwijnen en nieuwe komen tot bloei, maar sommige lijken eeuwig te blijven bestaan al blijken nieuwe inzichten anders te hebben bewezen. De standaardisatie processen dienen als referentie om stabiliteit te creëren of om langdurige handelsbelemmeringen op te werpen. Fabrikanten van testapparatuur, testinstituten en de industrie willen een economisch rendement op hun investeringen m.b.t. internationale standaard ontwikkeling, testapparatuur ontwikkeling, en de bijbehorende beperkingen die al deze eisen hebben op de producten en apparaten die aan deze gevestigde normen en standaarden moeten voldoen.

For many years national and international norms and standards have been established to make device and product design and manufacturing life easier or at least defined within bounds. In most cases, there is even a life-cycle process for the norms and standards themselves. Old ones fade away and new ones flourish, but some remain everlasting though new insights have proven otherwise. The standardization processes are to create references and stability or to set long lasting trade barriers. Test equipment manufacturers, test houses and industry want an economic return on their investments w.r.t. international standard development, test equipment development, and the accompanying constraints all these requirements have on the products and devices that have to adhere these established norms and standards. To read this article in English, visit our website www.interferencetechnology.com.

SAMENVATTING

VERANDERING VAN de ontwerp-eisen heeft een enorme impact op de product- en de apparaat-ontwikkelingen in de elektronische industrie. Maar wat als de standaardisatie achter blijft en de eisen die gesteld worden niet meer geschikt zijn voor de problemen die zich voordoen in het speelveld van de eindgebruiker. Het is waar, elke behoefte of pakket van eisenverandering op de product en de apparaat ontwikkelingen heeft een impact op de gekozen productieprocessen, de ontwerpinspanningen, de verificatiemethodes en alle andere eisen aan de ontwikkelketen tot aan de eindgebruikers-omgeving (die nauwelijks kan worden veranderd en gezien moet worden als ultieme eindgebruiker eis).

Volgens het Systeem-Efficiënt ESD Design (SEED, zie ESDA 3rd White Book), moeten de ESD prestaties van nanoschaal ICs worden aangevuld met bijkomende beschermingsmaatregelen om in een eindgebruikers omgeving te kunnen voldoen. Op het niveau van het IC wordt het Human Body Model (HBM) of opgeladen Device Model (CDM) wordt gebruikt. Het Machine Model (MM)

Figuur 2: De I/V-gegevens na 70% van de TLP pulsbreedte met toenemende testspanning.

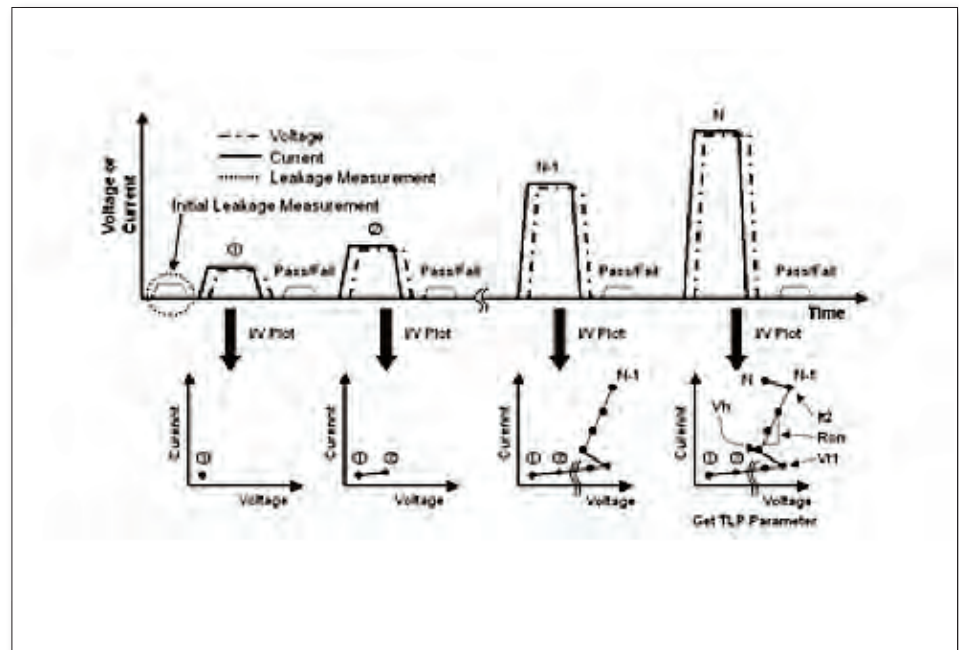

is officieel los gelaten. De Transmissie-Line test Methode (ANSI / ESD STM5.5.1-2008, IEC 60749-26TLM), met een pulsduur van 100 ns of zelfs de zeer snelle (very fast: vf) Transmissie-Line test Methode (ANSI / ESD SP5.5.2-2007, vf-TLM), meestal met een tijdsduur minder dan 10 ns, wordt zwaar gepromoot, maar er zijn (nog) geen kwantitatieve eisen gesteld die vergelijkbaar zijn met de HBM en CDM of de eindgebruiker niveaus (IEC 61000-4-2).

Vanwege de verdere miniaturisatie en de steeds dunnere gate en isolatie oxides in ICs, worden de ESD eisen die gesteld kunnen worden aan deze ICs minder Dienovereenkomstig, als de fysieke grenzen niet worden vermindert m.b.t. de stroomdichtheden en maximale veldsterkteniveaus die in isolerende materialen worden toegelaten, dan wordt het 'hot electron effect' in die regio overschreden. Als zodanig, gaan er aanvullende ESD-bescherming eisen gelden voor de productie, de IC processing, en verdere verwerking en assemblage gebieden. De ESD Protected Area (EPA) vereisten moeten aangehaald worden met twee of meer klassen: IEC 61340-xy of ANSI / ESD S20.20.

Een integrale aanpak is nodig over de gehele halfgeleider productieketen, van wafers zagen en polijsten, het belichten, processen tot het in blokjes snijden, lijmen/solderen, bonden, monteren, testen, tot opslag aan die nieuwe ESD-bescherming eisen die verder moeten gaan dan de huidige ANSI/ESD S20.20 eisen. Om deze EPA maatregelen over de gehele productieketen te verifiëren tot aan de eindgebruiker omgeving, dienen nieuwe eisen en testmethoden worden vastgesteld en dienen nieuwe referentie-databases met bewijzen te worden gebouwd (en daar is waar het opstent (= minder defecten) kan worden gestart).

INLEIDING

De 'oude' ESD testmethoden voor ICs komen voort uit de 'oude' MIL-STD 883 met multi-ns stijgtijd. De eisen waren in die dagen beperkt door de bandbreedte beperkingen van oscilloscopen en transient recorders. Deze waren vergelijkbaar met de 'oude' product eisen van de IEC 801-2

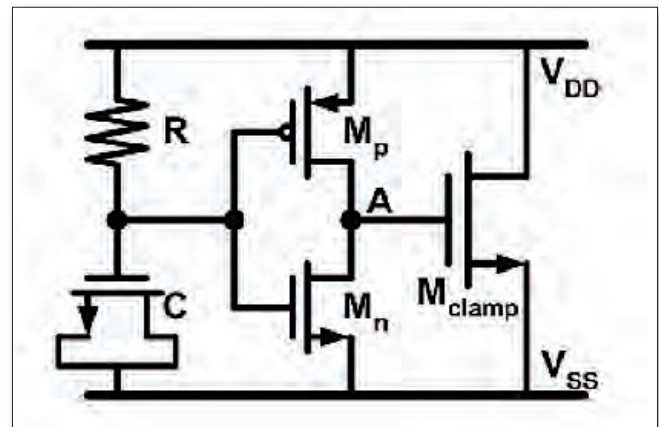

Figuur 1: Een voorbeeld van een vereenvoudigde puls getriggerd ESD beschermingscircuit.

(1984). In de tussentijd zijn de eindgebruiker ESD eisen bijgesteld naar de IEC 61000-4-2, 2008, wat neerkomt op de aanraking met een vinger van een staande persoon. De stijgtijd voor de eindgebruiker ESD pulsen zijn in het sub-nanoseconden bereik: 0,7 - 1 ns, gevolgd door een meer energieke ontlading tussen 30 - 60 ns na het eerste aanraken. Verdere onderzoeken zijn gaande waaruit blijkt dat metaal op metaal ontladingen al met tientallen picoseconden stijgtijd plaatsvinden. Het op IC niveau testen is opgewaarderd met de CDM-test (het laten vallen van statisch opgeladen ICs op een geaard metalen tafelblad), ook met sub-nanoseconden stijgtijd en korte pulsduur.

Het TLP testen werd in 1985 geïntroduceerd en wordt nu gepromoot als een Panacea tool die alle ESD-impulsen tot die van de eindgebruiker-eisen kan vervangen. De TLP methode kan dit theoretisch met enkele golfvorm 'shaping' netwerken, maar de commerciële verkrijgbare meetsystemen voldoen meestal niet. Vooral het feit dat alleen de I/V-punten genomen worden na 70% van de pulsbreedte heeft een mogelijke 'SEED' benadering onderuit gehaald.

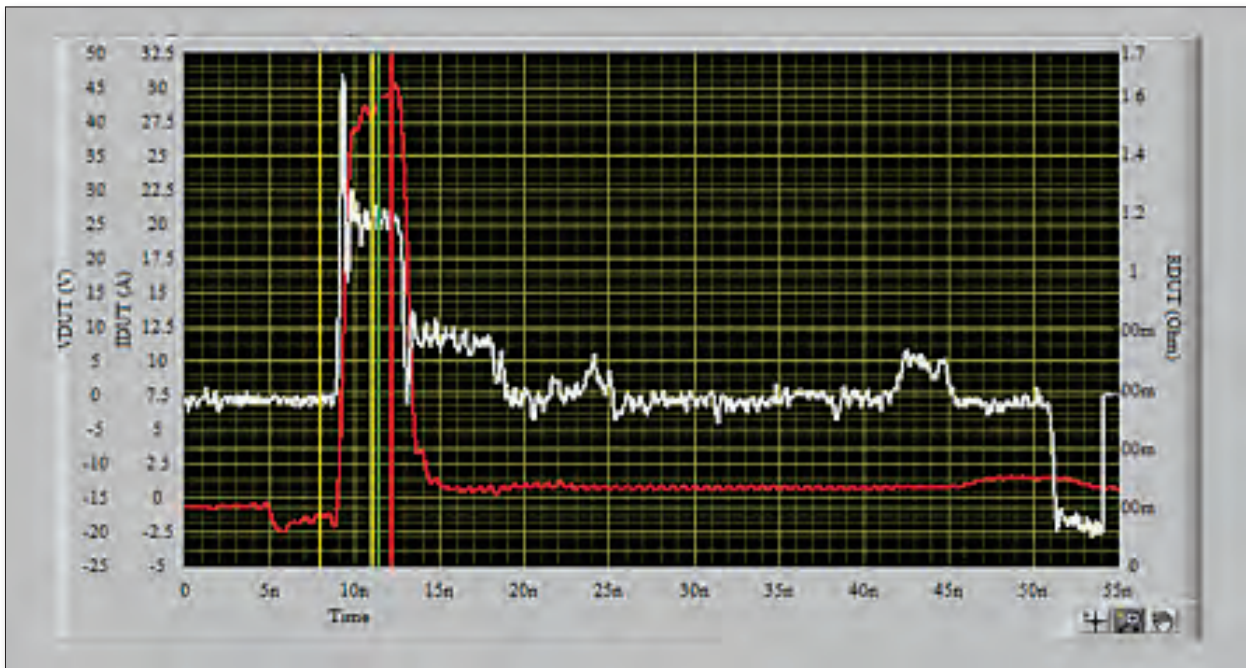

Figuur 3: Volledige TLP I/V reactie golfvorm op een enkele puls. Let op de eerste overspanning ten opzichte van de 70%-waarden.

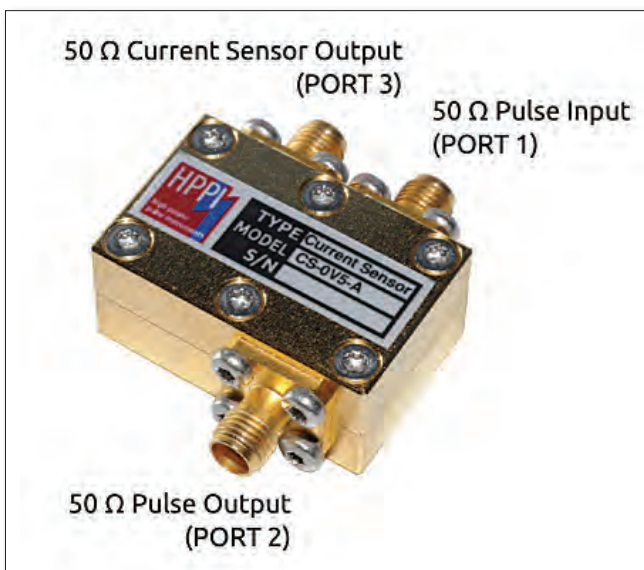

Figuur 4: Voorbeeld van een hoge bandbreedte (< 150 ps) stroomsensor.

SYSTEEM-EFFICIËNT ESD DESIGN (SEED)

Zoals gedefinieerd in de 3e White Book van de ESDA, is het de bedoeling om een integraal ESD-beschermingsnetwerk op te bouwen op een zodanige wijze dat de uiteindelijke interne functionele circuit is beschermd. Dit principe gaat ook op bij het IC-niveau waarbij de I/O of voedingssysteem moet worden beschermd door een extra beveiligingscircuit on-chip. Tegenwoordig worden de functionele I/O's en voedingcircuits afzonderlijk ontwikkeld en gekwalificeerd door verschillende designgroepen en uiteindelijk samen met de IC-pad beveiliging op het 'IC' geplaatst.

De meeste ESD beveiligingen zijn doorgaans dV/dt of drempelspanning geactiveerd, zie Figuur 1. Maar wat ge-

beurt er als het dV/dt getriggerde ESD-bescherming circuit wordt gebruikt parallel aan een voeding van een processor-core met een grote equivalente ontkoppelingscapaciteit? Het ESD-bescherming circuit is afzonderlijk gekwalificeerd voordat het in een IP-bibliotheek werd toegevoegd, dit vaak zonder overweging van de verdere toepassing. Door de parallelle capaciteit van de processor-core wordt de dV/dt op het ESD-bescherming circuit verminderd en als de dV/dt in die toepassing te laag is geworden, dan is de dV/dt getriggerd bescherming niet langer effectief. Als zodanig zal de ontladestroom, die optreedt bij de ESD event, de interne processor-core capaciteit opladen tot er een overspanning optreedt.

Als een externe drempelspanning-schakeling wordt gebruikt die refereert aan b.v. de +5 volt spanningsrail, terwijl de interne voedingsspanning van de te beschermen schakeling minder is, dan wordt geacht dat beide beveiligingen formeel werken zoals de bedoeling is, maar als deze circuits parallel worden gebruikt dan zal de externe beveiliging geen functie hebben als het eerste spanningsniveau wordt bereikt, gerefereerd aan de interne (lagere) voeding. Weer waar, het is als bij een tsunami; het externe beveiligingscircuit zal wel iets doen, maar alleen wanneer het op tijd wordt geactiveerd en zijn triggerspanning bereikt voordat het interne beveiligingscircuit het overneemt.

Het nemen van de spanning en stroom gegevens van de interne en externe beveiligingscircuits na 70% van de puls heeft geen zin, zie Figuur 2 en 3. Het nemen van de triggering spanning van beide beveiligingscircuits ook niet. Van beide beveiligingscircuits zijn de I/V-gegevens versus tijd nodig om uit te vinden welk pad de ontladestroom neemt. Als zodanig zijn de I/V-gegevens na 70% van de TLP puls niet zinvol. De gehele overgang versus tijd bevat cruciale informatie, zie Figuur 3. Alle TLP systemen genereren pulsen met stijgtijden in de orde van 100 ps of zelfs minder (≈ 3 GHz bandbreedte), de bemonsteringstijd

voor de stroom en spanning moet nog sneller worden genomen volgens Nyquist. Bovendien, de stroom en spanning meetdata, moet tegelijkertijd worden ingenomen met voldoende bandbreedte, zowel voor de oscilloscoop, als voor de gebruikte sensoren, zie Figuur 4.

Omdat de test met (vf-) TLP kunstmatig is t.o.v. de echte ESD verschijnselen, is het nog de vraag of de complete meetdata: I/V versus tijd, geschikt genoeg is om een SEED voorspelling mogelijk te maken. Nogmaals, waar ... alleen door het hebben van de gehele I/V versus tijd meetdata zal een juiste invoer voor analoge circuit simulaties mogelijk zijn. Ook de invoeren van specifieke gediscrèteerde en geëxtraheerde 3D-lay-out informatie van de PCB en IC-behuizingen is in deze vergelijking mogelijk.

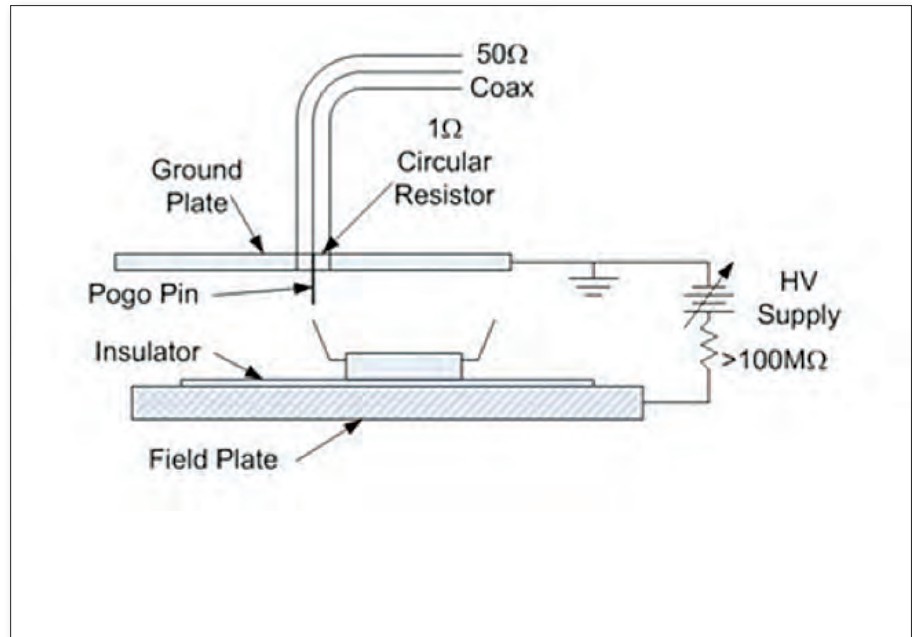

Figuur 5: Vereenvoudigde CDM testopstelling.

CDM

Het opladen van een IC m.b.v. een geladen plaat bij de CDM testmethode is RF-matig niet goed gedefinieerd. Het referentievlak met de $1\ \Omega$ meetweerstand heeft geen RF-ontkoppeling naar de geladen plaat, zie Figuur 5. Theoretisch is de maximale di/dt bepaald door de geladen spanning van het IC (in de richting van de meetweerstand referentievlak, niet de laadplaat!) gedeeld door $1\ \Omega$. In werkelijkheid, bij de commercieel aangeboden CDM testsystemen wordt de di/dt direct beperkt door de lengte van de gebruikte test (pogo) pin. Als de CDM standaard update wordt uitgevoerd tussen ANSI/JEDEC en ESDA, dan zouden de kritische factoren voor het testen d.w.z. voor kwalificatie en kwantificering moeten worden geïdentificeerd en zouden de beperkingen op die parameters moeten worden gegeven. Anders wordt de gehele CDM testmethode reduceert tot een uniforme testmethode die, zolang iedereen dezelfde fouten maakt, wordt gedegradeerd tot een gemeenschappelijk relatieve testmethode in plaats van een absolute.

CONCLUSIES

Voordat men kan beginnen met het zaaien, kweken en oogsten zal er nog veel moeten veranderen, wat niet in een nacht zal plaatsvinden. Maar om de juiste SEED parameters te kunnen oogsten, moet men eerst de weg van de metingen en karakterisering passeren. De ingrediënten voor een kunstmatige ESD-meting door de TLP-methode zijn er, maar de juiste toepassing om de SEED gegevens correct te verzamelen en toe te passen ontbreekt.

De SEED aanpak geldt niet alleen tussen de IC's en de externe beveiligingen, maar ook tussen de on-chip circuits en I/O's en voeding ESD-bescherming circuits on-chip. Als gescheiden referenties worden gebruikt; VSSA, VSSD, VSSX, enz., dient ook hier de SEED-benadering te worden aangenomen, dit om een correcte ESD werking te kunnen

garanderen.

Alleen dV/dt getriggerd ESD-bescherming circuits zijn zeer waarschijnlijk niet gekwalificeerd in combinatie met hun echte applicatie.

Het bereiken van SEED draagt meer beperkingen in haar toepassing anders dan het parallel plaatsen van de externe en on-chip ESD-bescherming circuits. De aangenomen signaal/voeding-referenties zijn cruciaal m.b.t. de te bereiken ESD prestaties.

Niet alleen de (vf-) TLP testmethode moet worden aangepast, maar ook de CDM testmethode moet worden bijgewerkt, dit om het een eenduidige testmethode te laten worden.

De ultieme ESD eisen zullen worden gebaseerd op de eindgebruiker omgeving die waarschijnlijk niet zal veranderen. Als zodanig moet de IEC 61000-4-2 of de ISO 10605 voor een automotive omgeving worden nageleefd.

BIOGRAFIE

Mart Coenen heeft meer dan 33 jaar ervaring in het EMC in verschillende gebieden gehad en heeft boeken, nationale en internationale kranten en publicaties verschenen. Hij is actief betrokken bij internationale EMC standaardisatie sinds 1988 en is de voormalige projectleider van normen IEC 61000-4-6 en IEC 61000-4-2; Later verhuisde hij zijn focus naar EMC in geïntegreerde circuits. Coenen heeft de convener van IEC TC47A / WG9 en lid van WG2, waarvoor hij werd gezien de IEC 1906 award in 2006 geweest, na de publicatie van verschillende delen van de IEC 61967-x, IEC 62132-x en IEC 62215-X-serie. Hij is mede-oprichter van de Nederlandse EMC / ESD Vereniging en heeft een part-time docent aan de post-academische cursussen EMC geweest voor de afgelopen 27 jaar. Coenen heeft zijn prive-adviesbureau EMCMCC eigendom sinds 1994, waar hij zich richt op PI, SI, EMC en systeemintegratie in het E-hardware. Hij kan bij mart.coenen@emcmcc.nl worden gecontacteerd.

SCHWEIZ

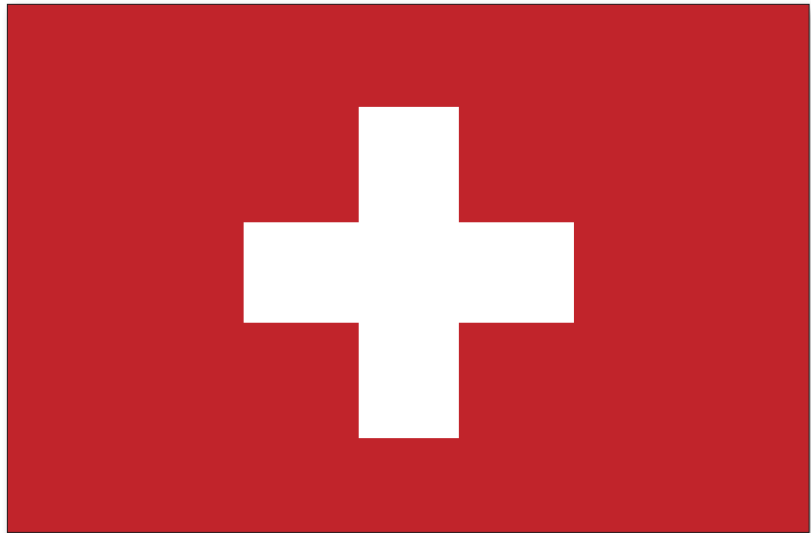

122 **PRODUKTE UND
SERVICES**

123 **RESSOURCEN**

Your Total EMC Source for Over 45 Years



1 to 2.5 GHz Solid State Amplifiers

The solid state alternative to TWTA's. Improved harmonics, lower noise, superior linearity and reliability and now featuring 3,000 watts CW.



16,000 Watts of Pure Power

The new 16000A225 amp. It covers 10 kHz to 225 MHz and delivers 16,000 watts of power and we're not stopping there. Call us for power levels up to 50,000 watts.



"W" Series Amplifiers

The most advanced, highest power and innovative RF Solid State amplifiers in the world. Now providing up to 4000 Watts CW from 80 to 1000 MHz.



Integrated Test Systems

All-in-one test systems for any EMC application, DC to 50 GHz. Our systems make testing more efficient, accurate, and affordable.



Radiant Aroni® Bent Element Antennas

We bent the rules and advanced the science of log periodic antennas. Smaller, lighter, and more compact to fit in smaller chambers.



0.7 to 18 GHz Amplifiers

Solid State Class A CW Amplifiers up to 200 Watts from 0.7 – 6 GHz and 40 Watts from 4-18 GHz. Now you don't have to settle for TWTAs.

RF Conducted Immunity Test Systems

Self-contained systems driven by our proprietary software; simplify calibration, testing, troubleshooting and reporting. They allow accurate, sensitive and repeatable measurement in one unit. Power levels to 150 watts and up to 3 GHz.



multistar family of products

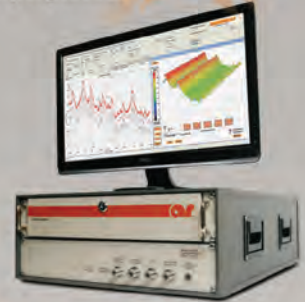

Precision DSP Receiver

This 18 GHz EMI receiver changes the way you think about emissions testing. Data is more accurate and test time is reduced.



Multi-Tone Tester

This incredible system cuts RF Radiated Immunity testing from days down to hours by testing multiple frequencies simultaneously, from 10 kHz to 6 GHz, reducing product development cost and time to market.



Field Analyzer

The new series of laser-powered electric field analyzers have an extremely high sample rate and can precisely measure pulsed electric fields in the microsecond range.

www.ar-europe.ie

info@emitec.ch

+41 41 748 6010

ISO 9001:2008
Certified

ar europe

National Technology Park, Ashling Building, Limerick, Ireland • +353 61 504300 • www.ar-europe.ie

In Europe, call ar United Kingdom +44 1908 282766 • ar France +33147917530 • ar Deutschland +49 6101 802700 • ar Benelux +31 172 423000

www.arworld.us

Copyright © 2014 AR. The orange stripe on AR products is Reg. U.S. Pat. & TM. Off.



PRODUKTE UND SERVICES

A



A.H. Systems

Pro Nova Elektronik GmbH; Ludwigsburg, Deutschland
+49 7141 2858 20; Fax: +49 7141 2858 29
info@pn.com.de; www.AHSystems.com
Produkte und Services: Antennen, Testausstattung, Testen



AR/RF Microwave Instrumentation

Emitec AG, Business Cube, Birkenstrasse 47, Rotkreuz, Schweiz 6343;
+41 41 748 6010; Fax: +41 41 748 5055;
Armin Diethelm, info@emitec.ch; Peter Wuethrich,
p.wuethrich@emitec.ch; www.emitec.ch
Produkte und Services: Verstärker, Antennen, Kabel und Stecker, Abgeschirmte Räume und Gehäuse, Überspannung und Einschaltstöße, Testausstattung

Arrow Europe

Riedmatt 9 8153 Rumlang, Schweiz
+41 44 8176-217; www.arroweurope.com
Produkte und Services: Ferrite, Kabel und Steckverbinder, Power Applications

C

Carlisle Interconnect Technologies

United Kingdom
+44-7817-731-000
Andy Bowne, Andy.Bowne@carlisleit.com
www.CarlisleIT.com
Produkte und Services: Filter

Communications & Power Industries

Shiraz Dewji and Miro Antelj, Communications & Power Industries International Inc., Cham, Schweiz
+41 41 560 7550; Fax: +41 41 560 7551
shiraz.dewji@cpi.com
Produkte und Services: Verstärker

EMCO Elektronik GmbH

Bunsenstrasse 5, D-82152 Planegg
T: +49 (0)89-895565-25
dwaser@emco-elektronik.de; www.comtest.eu
Produkte und Services: Absorberhallen, Hallräume, RF geschirmte Räume und Türen, Mikrowelle Absorber

E



EM TEST AG

EMITEC Messtechnik AG, Business Cube, Birkenstrasse 47, 6343 Rotkreuz, Schweiz; +41 41 748 60 10; +41 41 748 60 11; info@emitec.ch; www.emitec.ch
Produkte und Services: Innovative Prüf- und Testsysteme für leitungsgebundene Störfestigkeits-Prüfungen, ESD, Transienten, Harmonics & Flicker, Safetytests, akkreditiertes Kalibrierlabor, EMV-Prüflabor, Seminare, Workshops, Consulting

EMC PARTNER AG

Roschi Rohde & Schwarz AG; Mühlestrasse 7, 3063 Ittigen, Schweiz; +41 31 922 15 22; Fax: +41 31 921 81 01
sales@roschi.rohde-schwarz.com; roschi.rohde-schwarz.com
Produkte und Services: Überspannung und Einschaltstöße, Testausstattung

Emitec AG

Business Cube, Birkenstrasse 47, Rotkreuz, ZG, 6343, Schweiz; +41 41 748 6010; Fax: +41 41 748 6011
nfo@emitec.ch; www.emitec.ch
Produkte und Services: Testausstattung, Verstärker, Antennen, Überspannung und Einschaltstöße

Euro EMC Service

Dr.-Ing. D. Hansen, Bahnhofstr. 39, POB 84, CH 8965 Berikon, Schweiz
+41 56 633 7381; Fax: +41 56 633 7381
euro.emc.service@swissonline.ch; Euro-emc-service.de
Produkte und Services: Berater

F



Fair-Rite Products

Dantronic AG, Motorenstrasse 100, 8620 Wetzikon / ZH, Schweiz

+41 44 931 2233; Fax: +41 44 931 2200
sales@dantronic.ch; www.fair-rite.com
Produkte und Services: Ferrit, Filter, Abgeschirmte Räume und Gehäuse, Abschirmung

G

Gowanda Electronics

Sicovend AG; Alte Poststrasse 1, Kempththal, Schweiz, CH-8310
+41 52 354 8080; Fax: +41 52 354 8000
info@sicovend.ch; www.sicovend.ch
Produkte und Services: Induktoren

H

Haefely Test AG

Roschi Rohde & Schwarz AG, Mühlestrasse 7, CH 3063 Ittigen, Schweiz
+41 31 922 1522; Fax: +41 31 921 8101
Kurt Schilter, sales@roschi.rohde-schwarz.com
www.roschi.rohde-schwarz.ch
Produkte und Services: Überspannung und Einschaltstöße, Testausstattung

I



RF/Microwave Amplifiers

IFI - Instruments for Industry

Teseq AG, Nordstrasse 11F, 4542 Luterbach; +41 32 681 40 40; Fax +41 32 681 40 48; sales@teseq.com; www.ametek-cts.com
Produkte und Services: High Power Microwave and RF Amplifiers (Tetrode Tubes, Solid State and TWT) up to 40 GHz

L

Langer EMV-Technik GmbH Emitec AG

ROSCHI ROHDE & SCHWARZ AG,
Mühlestrasse 7, CH - 3063 Ittigen, Schweiz
+41 (0)31 92-215 22; Fax: +41 (0)31 92-181 01
sales@roschi.rohde-schwarz.com
www.roschi.rohde-schwarz.ch; www.langer-emv.de
Produkte und Services: Testausstattung

M



RF/Microwave Amplifiers

MILMEGA

Teseq AG, Nordstrasse 11F, 4542 Luterbach; +41 32 681 40 40; Fax +41 32 681 40 48; sales@teseq.com; www.ametek-cts.com

Produkte und Services: High Power RF and Microwave solid state amplifiers. Frequency range 80MHz up to 6GHz, with output powers to 1kW

N

Negal Engineering AG

Gaiserwaldstrasse 16A, CH-9015 St.Gallen, Schweiz
+41 (0)71 245 87 03

philipp.romann@negal.ch; www.negal.ch

Produkte und Services: Leistungselektronik-Lösungen für den industriellen Bereich und LED-Beleuchtung

R



A division of **Astrodyne**
Now you have power.

Radius Power

Eurocomp Elektronik GmbH
Nördlicher Park 17, D-61231 Bad Nauheim, Deutschland
+49 7146 860660 Fax: +49 7146 860662
Dieter Kunick; d.kunick@eurocomp.de
Produkte und Services: EMI/EMC/RFI filter



Roschi Rohde & Schwarz AG

Mühlestrasse 7, 3063 Ittigen, Schweiz
+41 (0) 31 922 15 22; Fax: +41 (0) 31 921 81 01
sales@roschi.rohde-schwarz.com
www.roschi.rohde-schwarz.ch

Produkte und Services: EMV Messgeräte und Zubehör, Breitband Leistungsverstärker, EMV Testsoftware, Schlüsselfertige Testsystem-Lösungen



Schlegel Electronic Materials

AWAG Elektrotechnik AG, Sandbühlstrasse 2, CH-8604 Volketswil, Schweiz
+41 44 908 1919; Fax +41 44 908 1999

Oliver Huber, info@awag.ch; www.awag.ch

Produkte und Services: Leitungsmaterialien, Abschirmung

SCHURTER AG

Werkhofstrasse 8-12, Postfach, 6002 Luzern, Schweiz
+41 41 369 31 11; Fax: +41 41 369 33 33

Herbert Blum; herbert.blum@schurter.ch
www.schurter.com
Produkt und Services: Filter, Drosseln, Testen

T



Advanced Test Solutions for EMC

Teseq AG

Teseq AG, Nordstrasse 11F, 4542 Luterbach; +41 32 681 40 40; Fax +41 32 681 40 48; sales@teseq.com; www.ametek-cts.com

Produkt und Services: Verstärker (HF & Mikrowellen), Antennen, Automotive Systeme, leitungsgebundene Störfestigkeit, leitungsgebundene Überspannung & schnelle Transienten, ESD, Netzoberwellen & Flicker, GTEM Zellen, HF Immunitäts- und Emissionssysteme, HF Testsoftware, Kalibration & Service

W



Würth Elektronik Schweiz

Witikonstr. 409, CH-8053 Zürich, Schweiz
Tel. +41 (0) 44 269 61 61; eiSos-swiss@we-online.com
Produkt und Services: Kabel und Steckverbinder, Ferrite



CDN HSS-2 - HIGH SPEED TELECOM LINE SURGE TESTING

Das neue CDN HSS-2 Koppel-/Entkoppelnetzwerk wurde speziell konzipiert zur Kopplung von 1,2/50 µs Surge-Impulsen auf ungeschirmte symmetrische High-Speed-Kommunikationsleitungen. Es eignet sich perfekt zum Testen von ISDN, Ethernet 10/100/1000BaseT oder Power over Ethernet (PoE) Leitungen mit Datenraten von bis zu 1.000 Mbit/s. Das vielseitige CDN HSS-2 bietet Koppelkonfigurationen für 1, 2 oder 4 Leiterpaare über je einem 40 Ω-Widerstand und Kondensator. Die hochwertigen Entkoppeleigenschaften ermöglichen Pulsformen, welche von Zusatzeinrichtungen (AE) unbeeinflusst bleiben, und sorgen somit für eine hohe Reproduzierbarkeit der Messung. Bei einer 2 kV Surge-Pulsspannung beträgt die Restspannung am AE-Port lediglich 65 V und erübrigt zusätzliche Entkoppelelemente. Das CDN HSS-2 erfüllt die Anforderungen der neuen IEC 61000-4-5 (Ed.3 2014) und kann sowohl mit Teseq's NSG-Serie als auch mit anderen branchenüblichen Surge-Generatoren verwendet werden.

Highlights:

- ISDN, Ethernet und PoE kompatibel
- Test bei Geschwindigkeiten bis zu 1000BaseT
- Effiziente Entkopplung sorgt für hohe Reproduzierbarkeit
- Kein zusätzlicher AE Schutz erforderlich
- Verwendung mit jedem Surge-Generator
- Erfüllt dritte Ausgabe der IEC 61000-4-5 Norm

Teseq AG Luterbach Schweiz
T + 41 32 681 40 40 F + 41 32 681 40 48
sales@teseq.com www.teseq.ch



Advanced Test Solutions for EMC

BELGIQUE

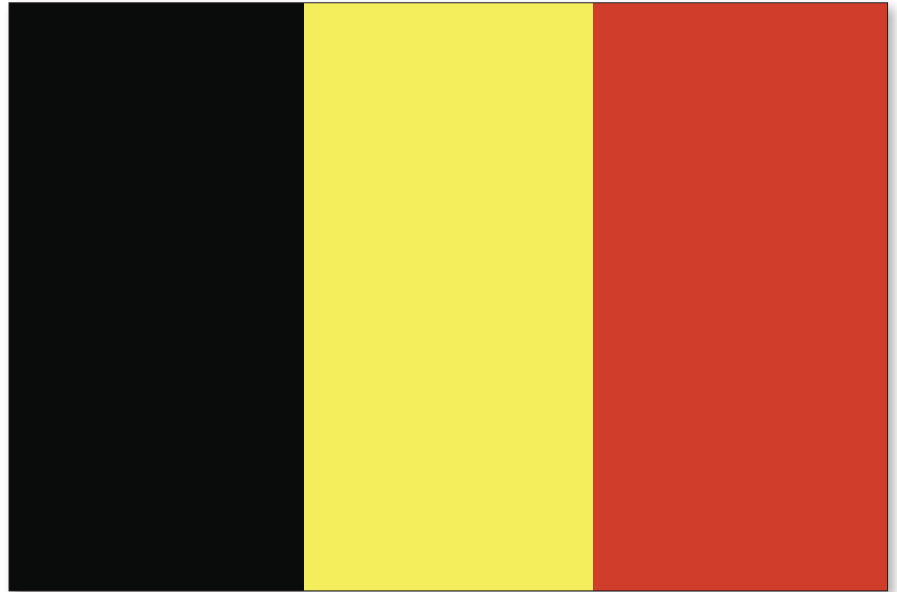

126 **PRODUITS ET SERVICES**

127 **RESSOURCES**

128 **ARTICLES**

**Caractérisation des Joints de Blindage
Électromagnétique Jusque 40 GHz**

CHRISTIAN BRULL, Schlegel EMI



uniek [bn.; -er, -st]

1 waarvan geen tweede exemplaar bestaat, syn. enig: een unieke exemplaar; een unieke gelegenheid, zoals nooit meer terugkomt

2 (fig.) onvergelijkelijk (mooi, goed), syn. heerlijk, kostelijk, enig

Introductie van de Enige 4000 watt CW, 80-1000 MHz versterker in zijn soort

Meestal praten we over alle functies die onze versterkers superieur maken aan alle andere versterkers, maar deze keer kunnen we dat niet. Er is gewoon geen andere klasse A 4000 watt versterker met een frequentie bereik van 80-1000 MHz. Niet alleen is AR's model 4000W1000B een klasse apart, hij is ook nog eens 65% kleiner dan het vorige model. Wanneer u deze 4000 watt versterker aanschaft, krijgt u een robuust, duurzaam en uiterst betrouwbaar product dat keer op keer z'n verwachtingen waarmaakt.

AR versterkers presteren boven verwachting, boven de norm en boven de mogelijkheden van gewone versterkers. AR is al meer dan 45 jaar marktleider en biedt een ongeëvenaard support netwerk voor technische ondersteuning en service waar u op terug kunt vallen voor praktisch advies en het oplossen van incidentele problemen.

Als u een AR 4000 watt, 80-1000 MHz versterker koopt of een model met minder vermogen, zit u altijd goed. www.ar-europe.ie/4000W

arbeneluxinfo@arworld.us

+31 172 423000

ISO 9001:2008
Certified

ar europe

National Technology Park, Ashling Building, Limerick, Ireland • +353 61 504300 • www.ar-europe.ie

In Europe, call ar United Kingdom +44 1908 282766 • ar France +33147917530 • ar Deutschland +49 6101 80270 0 • ar Benelux +31 172 423000

www.arworld.us

Copyright © 2014 AR. The orange stripe on AR products is Reg. U.S. Pat. & TM. Off.



PRODUITS ET SERVICES

A



A.H. Systems

EEMCCOIMEX, Apolloweg 80,
8239 DA, Lelystad, Nederland
+31 320 295 395; Fax: +31 320 413 133
info@eemc.nl; www.AHSystems.com

Produits et services: Antennes, Instrument de contrôle, Contrôles

ANPI

Parc scientifique Fleming, Rue Granbonpré 1, 1348 Louvain-la-Neuve, Belgique

+32(0) 10 47 52 11; Fax: +32(0) 10 47 52 70
info@anpi.be; www.anpi.be

Produits et services: Contrôles



AR Benelux B.V.

Frankrijklaan 7, ITC Boskoop,
NL-2391 PX, Hazerswoude-Dorp, Nederland
+31(0)172 423 000; Fax: +31(0)172 423 009
Stuart Mulhall, arbeneluxinfo@arworld.us;
www.arbenelux.com

Produits et services: Amplificateurs, Antennes, Câbles et connexions, Espaces sous protection et clôtures, Hausse et éléments temporaires, Instrument de contrôle

Arrow Europe

Keiberg II Minervastraat 14/B2 1930 Zaventem
+32 (0) 27 25 46 60; www.arroweurope.com

Produits et services: Ferrites, câbles et connecteurs, applications de puissance

B

Bekaert Fibre Technologies

President Kennedypark 18, B-8500 Kortrijk Belgique
+32(0) 56 23 05 11; Fax: +32 (0) 56 23 05 43
www.bekaert.com

Produits et services: Protection

BGEMC

Joseph Cardijnstraat 21, Erpe-Mere,
OVI, B-9420, Belgique
+32(0)53 60 16 01; Fax:+32(0)53 70 78 99

Johan De Temmerman; johan.de.temmerman@moreat-
mere.com; www.bgemc.com

Produits et services: Contrôles

C

Carlisle Interconnect Technologies

United Kingdom
+44-7817-731-000

Andy Bowne, Andy.Bowne@carlisleit.com; www.
CarlisleIT.com

Produits et services: Filtres



Comtest Engineering bv

Industrieweg 12, 2382 NV Zoeterwoude
Nederland

+31 71 5417531; info@comtest.eu

Produits et services: Anechoic chambers, Reverberation chambers, RF shielded rooms & doors, microwave absorbers

D

Dow Corning Corporation

Dow Corning Europe SA, Parc Industriel - Zone C, Rue Jules
Bordet, 7180 Seneffe, Belgique

+32 64 511 163, Fax: +32 64 888 401

Linda Coughlin, l.m.coughlin@dowcorning.com;
www.dowcorning.com

Produits et services: Test

E

EEMCCOIMEX

Apolloweg 80, 8239 Da Lelystad, Nederland
+31(0)32 029 5395; Fax: +31(0)32 041 3133
info@eemc.nl; www.eemc.nl

Producten en services: Afdichtingen, afschermingen, geleidende materialen, filters, ferrieten, versterkers, antennes, test apparatuur en afgeschermdde ruimtes



EM Test AG

Accelonix BV, Postbus 7044, 5605 JA Eindhoven, Netherlands; +31 40 750 1650; Fax: +31 40 293 0722; sales@
accelonix.nl; www.accelonix.nl

Produits et services: Products and Services: Innovative test- and measurementsystems für conducted immunity tests, ESD, transients, automotive, harmonics & flicker, AC/DC-sources, safetytest systems, accredited calibrations, seminars, workshops, consulting

EMC Partner

Decatel S.A, Rue de la Technologie 31BE,
1082 Berchem-Ste-Agathe, Belgique
+32 2 469 00 90; Fax: +32 2 469 06 07
info@decatel.be; www.decatel.be

Produits et services: Hausse et éléments temporaires, Instrument de contrôle

F



Fair-Rite Products Corp.

HF Technology, Atalanta 5, 1562 LC Krommenie, Holland
+31 (0)75 - 628 37 17; Fax: +31 (0)75 - 621 11 20

info@hftechnology.nl; www.fair-rite.com

Produits et services: Ferrite, Filtres, Espaces sous protection et clôtures, Protection

I



RF/Microwave Amplifiers

IFI - Instruments for Industry

Accelonix BV, Postbus 7044,
5605 JA Eindhoven, Nederland
+31 40 750 1650; Fax: +31 40 293 0722
sales@accelonix.nl; www.accelonix.nl

Produits et services: High Power Microwave and RF Amplifiers (Tetrode Tubes, Solid State and TWT) up to 40 GHz

L

Laborelec

Rodestraat 125, B-1630 Linkebeek, Belgique,

+32(0)2 382 02 11; Fax: +32(0)2 382 02 41
info@laborelec.com; www.laborelec.com

Produits et services: Contrôles

M



RF/Microwave Amplifiers

MILMEGA

Accelonix BV, Postbus 7044,
5605 JA Eindhoven, Nederland
+31 40 750 1650; Fax: +31 40 293 0722
sales@accelonix.nl; www.accelonix.nl
Produits et services: High Power RF and Microwave solid state amplifiers.
Frequency range 80MHz up to 6GHz, with output powers to 1kW

N

nexio

Nexio

EEMC Coimex, Apolloweg 808239 Da Lelystad, Nederland
+31 320 295 395; Fax: +31 320 413 133
www.eemc.nl/eng; info@eemc.nl
Produits et services: Instrument de contrôle

R

ROHDE & SCHWARZ

Rohde & Schwarz Belgium N.V./S.A.

Excelsiorlaan 31, 1930 Zaventem
+32 (0) 2 721 50 02; Fax +32 (0) 2 725 09 36
Jos.Westhof-Jacobs, Jos.Westhof@rohde-schwarz.com;
www.rohde-schwarz.be
Produits et Services: EMC Équipement de test et accessoires, amplificateurs à large bande, logiciel de mesure de CEM, clé en main de tester des solutions de système

S

SCHLEGEL
electronic materials

Schlegel Electronic Materials

Ian Stocks; ian.stocks@schlegelemi.com
Schlegel Electronic Materials bvba
Slitpesteenweg 28, 8432 Middlekerke Leffinge, Belgium
+44 1274 850838; +44 1274 850828
www.schlegelemi.com
Produits et services: Matériaux conducteurs, Protection

T

Tech-Etch, Inc.

HF Technology, Atalanta 5,
1562 LC Krommenie, Nederland
+31 75 628 37 17; Fax: +31 75 621 11 20
info@hftechnology.nl; www.tech-etch.com
Produits et services: Matériaux conducteurs, Protection

T E S E O

Advanced Test Solutions for EMC

Teseq Ltd.

Accelonix BV, Postbus 7044,
5605 JA Eindhoven, Nederland
+31 40 750 1650; Fax: +31 40 293 0722
sales@accelonix.nl; www.accelonix.nl
Produits et services: Amplificateurs, antennes, Automotive Systems, Immunité aux perturbations conduites, les surtensions transitoires et conduites, l'EDD, Harmoniques et Flicker, les cellules GTEM, Systèmes d'immunité RF, RF Systems émission, logiciel de test RF, d'étalonnage et Servicetesting

W

WE
WÜRTH ELEKTRONIK

Würth Elektronik Belgique

Drabstraat 30, BE-2640 Mortsel, Belgique
Tel. +32 (0) 3 230 99 40
Produits et services: Ferrites, câble et fiche

Würth Elektronik Belgique

Rue Paul Hulin 41, BE-6180 Courcelles
+32 (0) 71 45 94 96; eiSos-belgium@we-online.com
Produits et services: Ferrites, câble et fich

ASSOCIATIONS

IEEE EMC SOCIETY CHAPTER BENELUX

Dodeweg 6B, 3832 RC Leusden, Postbus 366, 3830 AK Leusden, The Netherlands; +(033) 465 75 07; Fax: +(033) 461 66 38
Chairman Cees Keyer; c.h.a.keyer@hva.nl; www.emc-esd.nl

NETWAVE:
THE EUROPEAN POWER PACKAGE!

emtest
the benchmark for emc



The multifunctional AC/DC Power-Source NetWave and netwave.control software is

- > User friendly
- > Faster
- > More efficient
- > Easily reproducible



For IEC/EN 61000-4-13, -14, -17, -27, -28, Airbus, Boeing, DO-160, MIL-STD-704

Your partner for all your needs throughout BENELUX:

Accelonix BV > Croy 7F > 5653 LC Eindhoven > Netherlands > Tel.: +31 40 750 1650
Fax: +31 40 293 0722 > E-Mail: info@accelonix.nl > Internet: www.accelonix.nl

AMETEK
COMPLIANCE TEST SOLUTIONS

www.emtest.com

Caractérisation des Joints de Blindage électromagnétique Jusque 40 GHz

CHRISTIAN BRULL

Global Product Manager
Schlegel

Les joints de blindage électromagnétique sont des matériaux conducteurs conçus pour se conformer à la géométrie des ouvertures pour en diminuer l'impédance. Comprimé entre deux brides métalliques, le joint présente une impédance complexe dont les propriétés résistives, capacitives et inductives varient en fonction de paramètres tels que : la fréquence, les matériaux utilisés, le taux de compression, la géométrie de l'ouverture, etc. Dans le même temps, des différences importantes sont également observées entre les différents types de joints d'étanchéité électromagnétique.

Par exemple les joints en silicone chargés de particules conductrices présentent des variations importantes d'efficacité suivant le taux de compression (grandes variations du nombre de liaisons entre particules conductrices). La surface de contact est le principal critère pour les joints de type Tissu Conducteurs sur Mousse Polyuréthane et les doigts de blindage métalliques en cuivre béryllium présentent de grandes variations en fonction de la fréquence et des ouvertures entre chaque doigt. Comme on peut s'y attendre avec tous ces paramètres variables, la caractérisation d'un joint de blindage électromagnétique est plutôt un exercice difficile.

Pour comprendre les techniques de mesure disponibles pour l'industrie du joint de blindage, il faut se référer à la norme IEEE 1302 publiée pour la première fois en 1998 et révisée en 2008. Il s'agit d'un guide qui regroupe et compare la plupart des méthodes disponibles (en 2008) pour la caractérisation des joints CEM jusqu'à 18 GHz. Le document fournit une base pour comparer les différentes techniques en usage. Il se compose de trois sections: les méthodes normalisées, les méthodes dérivées des normes et des méthodes alternatives non normalisées. Chaque méthode ne sera pas abordée ici (se référer à la norme IEEE Std 1302) mais sans doute les plus utilisées.

La spécification la plus utilisée à ce jour est sans nul doute la norme Mil DTL 83528 C. Cette méthode basée sur l'atténuation d'ouverture, provenant de l'ex MIL

This article discusses the characterization of EMI shielding gaskets up to 40 GHz. EMI gaskets are conductive hardware's designed to conform to joint surface and provide a low impedance path. Compressed between two metal flanges, the gasket presents a complex impedance with resistive, inductive and capacitive properties. To understand what measurement techniques are currently available to the gasket industry, reference should be made to IEEE Std 1302 released for the first time in 1998 and revised in 2008. It is a guidance document which gathers and compares most of the methods available (in 2008) for the characterization of EMI gaskets from DC up to 18 GHz. The document provides a basis for comparing the different techniques in use. The standard the most commonly used so far is Mil DTL 83528 C. To read this article in English, visit our website www.interferencetechnology.com.

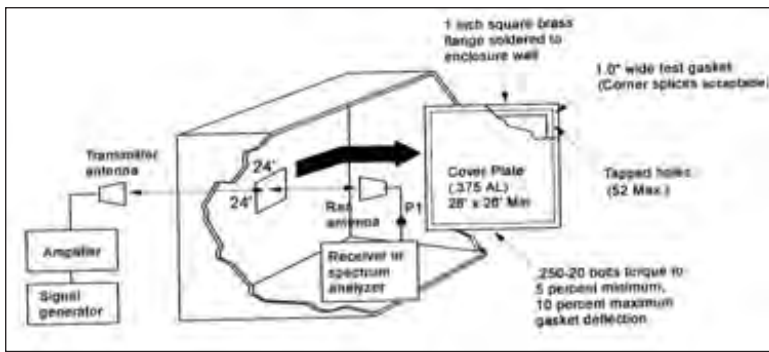

FIGURE 1: Mil-DTL 83528 C test set-up.



FIGURE 2: Mil-DTL 83528 C test set-up.

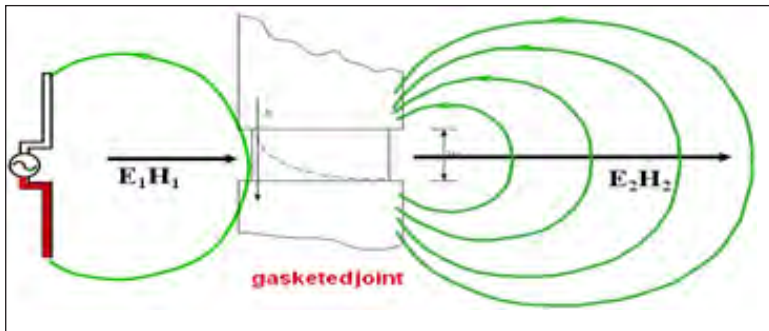

FIGURE 3: Impédance de transfert -principe.

STD 285 (remplacée par la norme IEEE 299) caractérise l'efficacité du blindage du joint de 20 MHz à 10 GHz (avec possibilité d'extension à 18 GHz). Le test requiert une chambre blindée avec une ouverture de 610/610 mm (24 "/ 24") pratiquée dans sa cloison avec une antenne d'émission à l'extérieur et une antenne de réception à l'intérieur de la chambre et deux mètres de distance entre les antennes.

Une première mesure est effectuée directement d'une antenne à l'autre à travers l'ouverture et une seconde mesure est effectuée lorsque l'ouverture est obturée au moyen d'une plaque de métal avec le joint à tester monté autour et comprimé. La méthode mesure donc le champ avant et après le panneau de fermeture et l'efficacité de blindage du joint d'étanchéité est égale à $20 \log_{10} E_1/E_2$ (H_1/H_2) ou la différence entre les deux mesures en dB de 20 MHz à 10 GHz.

La méthode a une reproductibilité théorique de +/- 6-10 dB. Cependant, cette reproductibilité peut se dégrader jusqu'à +/- 20 dB en fonction de la position de l'antenne lorsque la moitié de la longueur d'onde se rapproche de la dimension caractéristique de la chambre blindée (pour rappel, changement d'antenne en cours de test pour chacune des trois décades (20/100 MHz, 100/1000 MHz et 1000/10000 MHz)). Un autre problème est la taille des joints qui peuvent être testés par cette méthode. Le chevauchement de la plaque de métal sur la paroi de la chambre blindée induit un couplage capacitif qui affecte la mesure des joints de petites dimensions. Il y a d'autres questions telles que la taille de l'ouverture et de son atténuation naturelle du fait de ces dimensions, la limitation de la fréquence, l'influence des vis métalliques (remplacées parfois par des pinces isolées), etc. Dans la pratique, les valeurs absolues de l'efficacité de blindage doivent être prises avec beaucoup de prudence pour les

différentes raisons expliquées. On observe que la différence avec les valeurs réelles obtenues dans les applications augmente avec la fréquence. Le principal intérêt de la méthode est sans doute qu'elle est une norme de sorte que les mesures selon MIL DTL 83528C peuvent être comparées entre elles surtout si les tests sont pratiqués par des laboratoires indépendants. La norme exige un minimum de 5 mesures par décade et, très souvent, la

documentation technique sur les joints fournit la valeur moyenne des 15 mesures demandées.

L'autre norme utilisée est SAE ARP 1705, un procédé d'injection de courant qui mesure l'impédance de transfert des joints de blindage. Quand un champ électromagnétique vient frapper une barrière métallique constituée d'un joint comprimé par des brides métalliques, il y induit un courant par couplage (Fig. 3). Celui-ci crée une tension aux bornes de la jonction Joint/métal qui dès lors rayonne à son tour.

Dans la technique de mesure de l'impédance de transfert, un courant, supposé résultant du couplage avec un champ électromagnétique, est directement injecté dans la jonction métal/joint. La tension aux bornes du joint CEM est donc mesurée. Le rapport de la tension mesurée au courant injecté et rapportée à une longueur de 1 mètre, définit l'impédance de transfert du joint exprimée en dB Ohm / m. Ce procédé d'injection de courant a une bonne reproductibilité de +/- 3 à 6 dB. SAE ARP 1705 révision A (Fig. 4) est limitée à 1,5 GHz et une révision C en cours de développement devrait étendre la gamme de fréquence de DC à 10 ou 18 GHz. Le système de mesure peut facilement être modifié pour tester des modules de différents métaux permettant ainsi l'étude de la compatibilité galvanique joint/métal ou la dégradation du contact sous différentes conditions de vieillissement. Cette méthode fournit une indication directe de la conductivité de l'ensemble métal/joint mais des discussions sont toujours en cours quant à la relation qui lie l'impédance de transfert et l'efficacité de blindage.

Dans le modèle Shelkunoff, l'atténuation globale dans un matériau est la somme des taux de réflexion et d'absorption du matériau. Le couplage étant supprimé,



FIGURE 4: Impedance de transfert – SAE ARP 1705 rev. A.

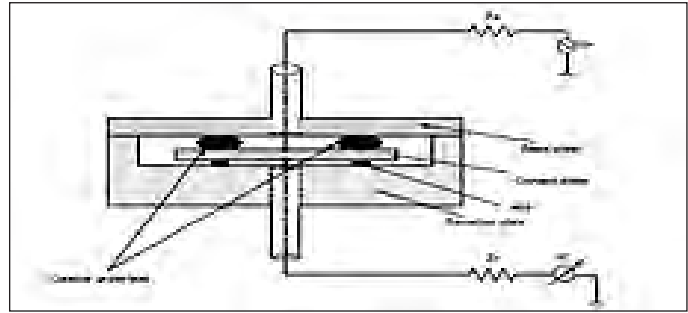

FIGURE 5: Impedance de transfert – principe diagram.



FIGURE 6: TEM-T.



FIGURE 7: Ht.

le taux de réflexion n'est en fait pas considéré dans la mesure de l'impédance de transfert.

Pour la mesure de l'efficacité de blindage des joints de petites tailles, la méthode des cellules TEM-T et Ht est recommandée. Il s'agit d'une méthode de mesure non normalisée mais reprise dans la norme IEEE Std 1302 et souvent utilisée en R&D en raison de sa bonne reproductibilité (1-3 dB). La cellule TEM-T est en fait une ligne de transmission en mode TEM (transverse électromagnétique) simulant les conditions du champ lointain. La structure coaxiale est coupée en son milieu de telle manière qu'un support ou porte-joint métallique puisse y être inséré. Dans la cellule Ht, l'utilisation de deux antennes en boucle de courant simulent le champ magnétique proche.

Dans l'exemple suivant, la cellule Ht a été utilisée pour évaluer l'influence d'une petite déformation à la base (Bump) d'un joint D tissu-sur-mousse et comparé au même joint sans modifications (Fig. 11 et 12). En théorie, cette légère déformation a pour but d'améliorer l'efficacité de blindage du joint quand il est monté avec de l'adhésif non conducteur et faiblement comprimé. Les mesures ont été prises à 0%, 10% et 20% d'écrasement (% à partir de la hauteur libre du joint). Le joint d'étanchéité électromagnétique, référence SEM DYNASHEAR TM EJ9, a une hauteur de 2,3 mm de sorte qu'une variation de compression de 10% ne représente qu'une modification d'écrasement de seulement 0,23 mm. Les résultats des mesures H-t (Fig. 13 et 14) montrent qu'un joint D

d'étanchéité à base plate nécessite une compression d'au moins 20% pour assurer un contact du fait de la couche isolante de l'adhésif tandis qu'une petite déformation à sa base assure déjà une efficacité de blindage substantielle à très faible compression. La cellule Ht est une excellente méthode pour visualiser l'effet de ces petites variations d'écrasement sur des joints de petites dimensions. Les valeurs absolues du blindage électromagnétique ne sont pas très élevées, mais c'est principalement dû à la faible distance séparant l'antenne du joint d'étanchéité et donc de la 'trop' bonne adaptation entre l'impédance caractéristique du champ magnétique et l'impédance intrinsèque du joint d'étanchéité. La gamme de fréquences de test de la cellule Ht est de 100 à 500 MHz.

La plupart des équipements électroniques travaillent à des vitesses plus élevées que par le passé et grâce aux dernières technologies, les systèmes prennent de moins en moins d'espace. La proximité crée dès lors de nouveaux défis avec plus de diaphonie entre circuits générant des perturbations sur le fonctionnement de l'appareil de sorte que préserver l'intégrité des signaux est devenu parfois plus difficile que d'assurer la conformité de l'équipement à une norme spécifique. Aux États-Unis, pour les mesures rayonnées, le FCC (Titre 47 partie 15.33) exige pour les systèmes ayant la fréquence la plus élevée supérieure ou égale à 1 GHz, de tester à la 5^{ème} harmonique avec une limite à 40 GHz. Tester son équipement à 40 GHz commence à être très commun dans certains secteurs de l'Électronique. Comme

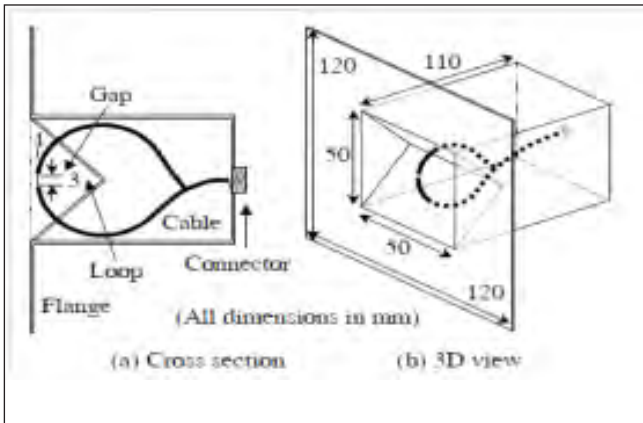
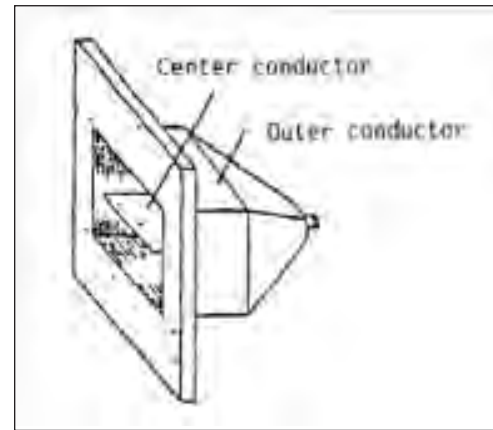
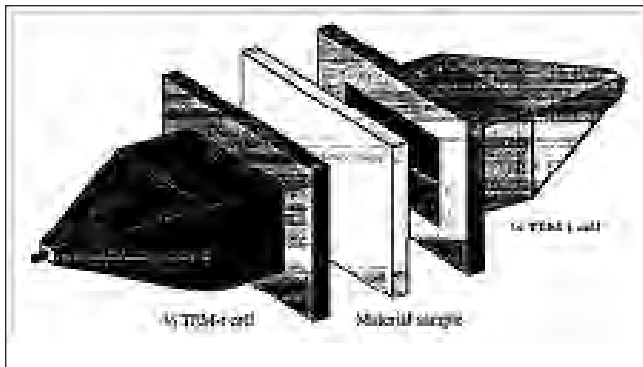

ce jour est la méthode stripline (Fig. 15).

Schlegel Electronic Materials, en partenariat avec les Professeurs J. Catrysse et D. Pissoort du groupe de recherche KULab REMI de la KUL (Université de Leuven-Belgique), ont développé une nouvelle méthode pour caractériser l'efficacité de blindage des joints conducteurs jusqu'à 40 GHz. Le principe est basé sur une méthode qui a été introduite par le Professeur B. Koerber pour mesurer les émissions et la susceptibilité des circuits intégrés (norme IEC 61967-8 et IEC 62132-8). La méthode utilise une antenne de type stripline qui se ferme sur une carte circuit imprimé avec le circuit intégré à tester (Fig. 16).

Dans le nouveau dispositif stripline, le circuit imprimé est remplacé par une petite antenne de type microstrip intégré dans une cavité dans le plan de masse (Fig. 21). La cavité peut être fermée au moyen d'une plaque métallique (Fig. 23) épaisse qui comprime le joint d'étanchéité en cours de test. Une antenne stripline referme l'ensemble décrit (Fig. 22).

La procédure de test, similaire au IEEE 299 ou Mil DTL 83528 C, se déroule comme suit:

- 1) Mesure directe de l'antenne microstrip à l'antenne stripline de manière à établir une référence (soit la mesure du signal avant blindage).
- 2) Mesure similaire mais avec la cavité fermée par la plaque métallique avec le joint en cours de test monté et comprimé sur le plan de masse (soit la mesure du signal après le blindage)
- 3) La différence entre les deux mesures en dB est l'efficacité de blindage du joint CEM.

La reproductibilité est excellente malgré des signaux bruyants. Nous pouvons voir sur les graphiques suivants (Fig. 17 et 18) la mesure du blindage électromagnétique obtenu de 1 à 40 GHz pour un joint Tissu-sur-Mousse de 9 mm par 3 mm (1 x h) et une bande de doigts de blindage en forme de D de même dimension mais avec une ouverture entre chaque doigt de 0,45 mm et une largeur de doigt de 4,32 mm. Les deux joints ont été écrasés à 50% de leur hauteur libre. Le joint tissu-sur-mousse a une réponse très régulière de l'ordre de 80 dB, alors que le joint d'étanchéité métallique affiche une baisse continue à partir de 12 GHz du fait de l'ouverture entre chaque doigt de blindage. L'atténuation varie en fonction des dimensions et formes de l'ouverture entre chaque doigt et la méthode stripline est un moyen intéressant de comprendre son impact sur l'efficacité de blindage à

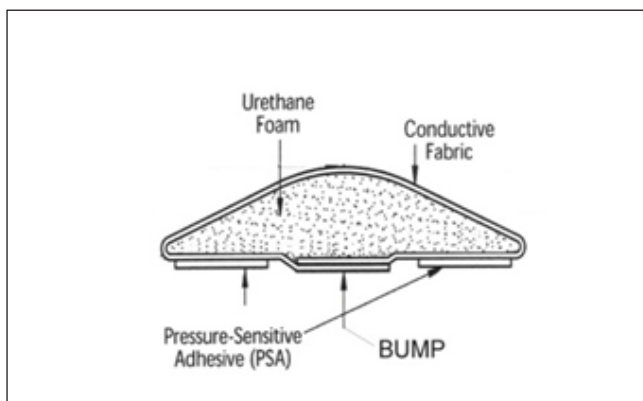
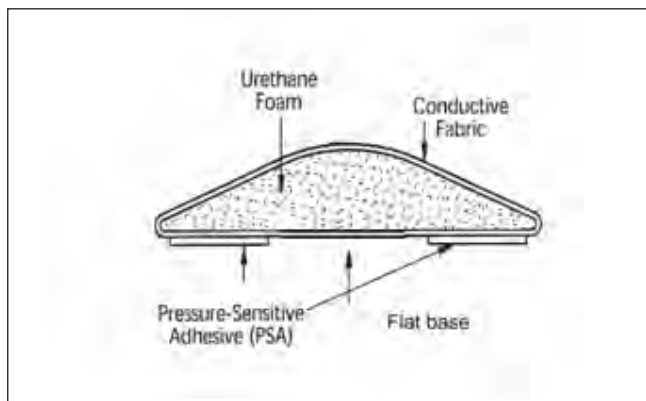

on peut le constater, il y a un écart important entre les normes disponibles pour l'industrie des joints CEM et les exigences du marché. Pour cette raison, un comité technique travaille sur la révision et l'extension de la norme IEEE 1302 de 18 GHz à 40 GHz. Pour le moment, il n'y a malheureusement pas beaucoup de recherches en cours pour de nouvelles méthodes de caractérisation des joints CEM jusqu'à 40 GHz. La plus importante à

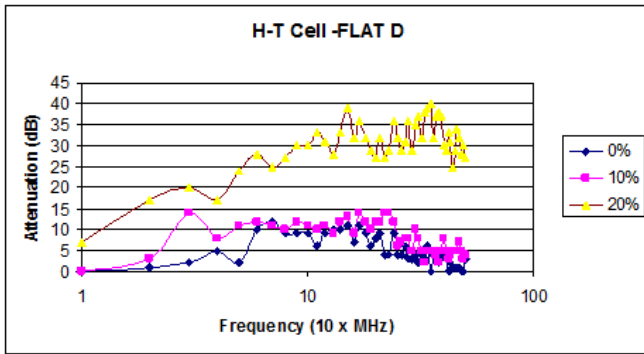

FIGURE 13: Joint à fond plat.

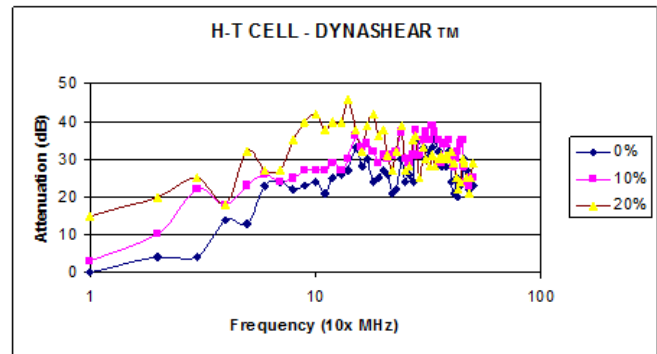

FIGURE 14: Joint avec déformation.

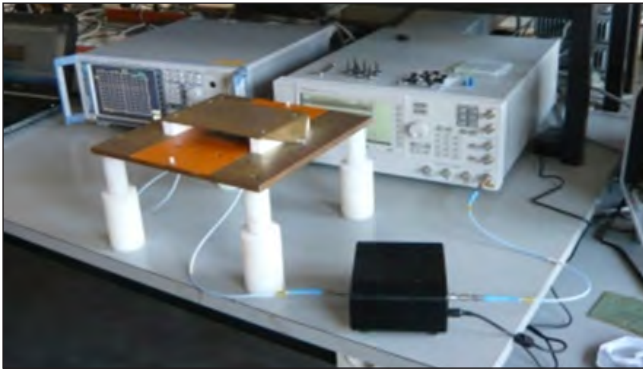

FIGURE 15: Stripline fixture.

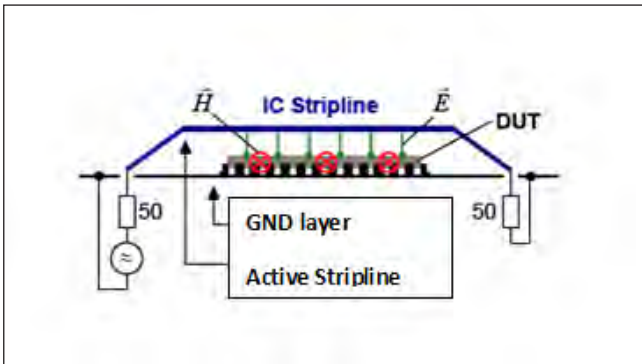

FIGURE 16: IEC 61967-8 / IEC 62132-8 -Principe.

haute fréquence.

Un autre exemple est la mesure de l'efficacité de blindage d'un joint de connecteur en tissu conducteur refermé sur un noyau de mousse non conducteur. Le joint d'étanchéité est fabriqué à la largeur désirée et ensuite découpé en fonction des dimensions du connecteur. Ce type de solution a bien fonctionné dans le passé, lorsque la plupart des problèmes rencontrés se situaient dans les 300 MHz..

La méthode Stripline montre que ce type de joint fonctionne jusqu'à 1 GHz (Fig. 19). En effet, avec l'augmentation de la fréquence, les ouvertures créées par la découpe sur le noyau de mousse non conducteur provoque une chute de son efficacité au dessus de 1 GHz. L'impédance résultante du chemin de retour du courant entre les brides peut même créer un effet d'antenne à des fréquences élevées. Par contre les mêmes tests réalisés sur un joint Tissu conducteur sur une âme en

mousse conductrice cette fois, montrent de grandes améliorations en termes d'atténuations (Fig. 20). A basse fréquence le tissu périphérique apporte la plus grande contribution à l'efficacité du joint et lorsque la fréquence augmente, l'âme en mousse conductrice prend la relève en assurant des atténuations substantielles. Le risque d'effet d'antenne est également diminué par un chemin de retour courant entre brides plus court. La méthode Stripline montre que ce type de construction de joint de blindage électromagnétique assure donc une efficacité constante sur une très large bande de fréquence (SEM Réf. ORS-II).

La méthode Stripline dispose d'autres caractéristiques intéressantes. L'antenne microstrip n'étant en fait qu'une piste sur un circuit imprimé, elle en reproduit donc l'environnement. Les résultats obtenus par cette méthode donnent donc une idée assez précise des atténuations attendues dans un environnement similaire. Pour cette même raison, la méthode peut être envisagée à l'avenir pour la caractérisation des capots de blindage pour circuits imprimés.

La méthode Stripline sera bientôt reprise par une norme de la SAE (Society of Automotive and Aerospace Engineers) sous la référence SAE ARP 6248.

LISTE DES RÉFÉRENCES

- IEEE Std 1302 –Rev. 2008 : IEEE Guide for the Electromagnetic Characterization of Conductive Gaskets in the Frequency Range of DC to 18 GHz
- J. Catrysse, F. Vanhee, D. Pissoort, C. Brull, and G. Vandenbosch, "A new stripline measuring setup for the characterisation of conductive gaskets up to 18 GHz", Proceedings of the IEEE International Conference on Electromagnetic Compatibility, Fort Lauderdale, Florida, USA, July 2010,
- J. Catrysse, F. Vanhee, D. Pissoort, C. Brull, and P. Reynaert, "Expanding the Stripline Measuring Set-up for the Characterisation of Conductive Gaskets up to 40 GHz", Proceedings of the IEEE International Conference on Electromagnetic Compatibility, Pittsburgh, Pennsylvania, USA, Aug. 2012
- J.Catrysse, T.Grenson, F.Vanhee, D.Pissoort and C. Brull, "The importance of continuous and homogeneous Gasket Conductivity up to 40 GHz", Proceedings of EMC Europe 2013 Brugge Symposium, Brugge, Sept. 2013
- Schelkunoff, S. A., Electromagnetic Waves. New York: Van Nostrand, 1943.

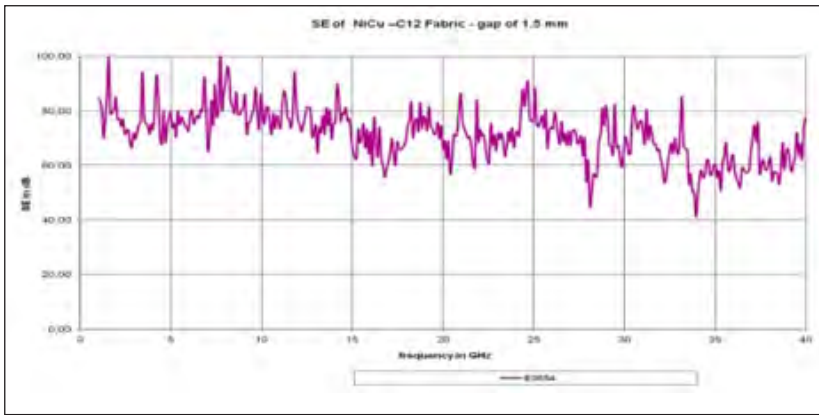

FIGURE 17: Tissu conducteur sur mousse.

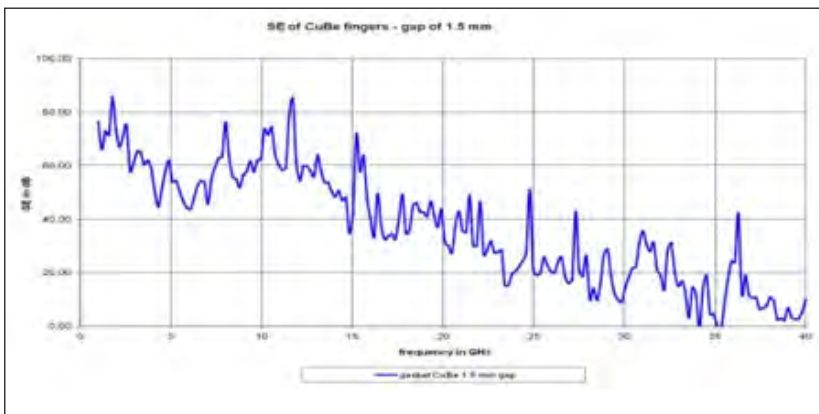

FIGURE 18: Cuivre Beryllium.

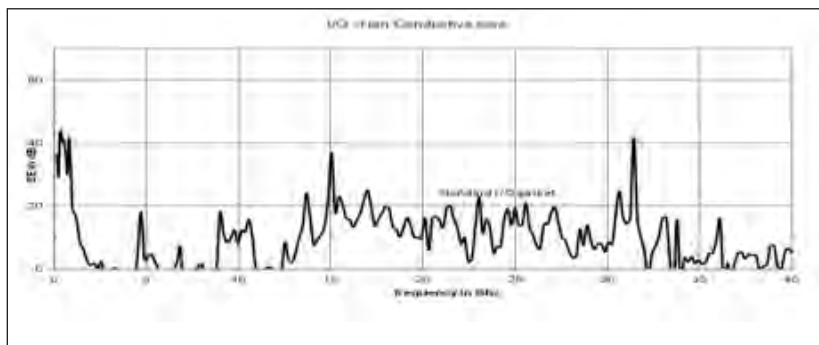

FIGURE 19: Tissu sur mousse non conductrice.

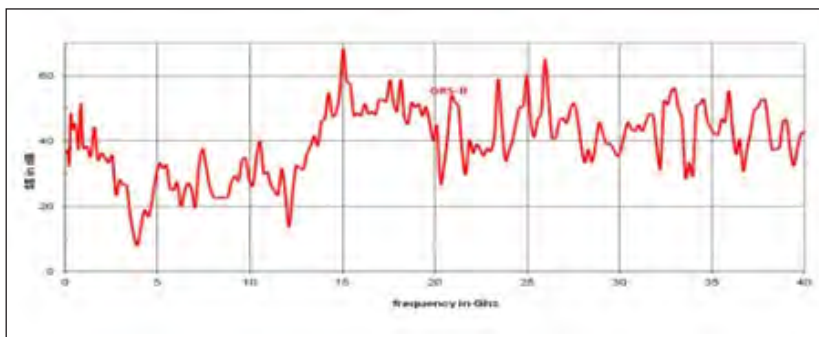

FIGURE 20: Tissu sur mousse conductrice.



FIGURE 21: μ -strip.



FIGURE 22: Stripline.

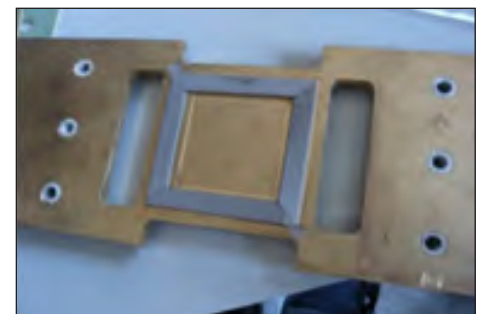

FIGURE 23: Plaque métallique et joint à tester.

ÖSTERREICH



136 **PRODUKTE UND
SERVICES**

Our Support Is As Strong As Our Products



- ✓ Upgrades, Verification, Calibration, Technical Support, Maintenance
- ✓ Four European Service Centres: UK, BENELUX, FRANCE and GERMANY
- ✓ Competent, Well Trained European Service Team
- ✓ First Class and Speedy Support

www.ar-europe.ie

ardeinfo@arworld.us

+49 6101 80270 0

ISO 9001:2008
Certified

ar europe

National Technology Park, Ashling Building, Limerick, Ireland • +353 61 504300 • www.ar-europe.ie

In Europe, call ar United Kingdom +44 1908 282766 • ar France +33147917530 • ar Deutschland +49 6101 80270 0 • ar Benelux +31 172 423000

www.arworld.us

Copyright © 2014 AR. The orange stripe on AR products is Reg. U.S. Pat. & TM. Off.



PRODUKTE UND SERVICES

A



A.H. Systems, Inc.
 Pro Nova Elektronik GmbH, Ludwigsburg, Österreich
 +49 7141 2858 20; Fax: +49 7141 2858 29
 info@pn.com.de
 www.AHSystems.com
Produkte und Services: Antennen, Testausstattung Testen



AR/RF Microwave Instrumentation
 AR Deutschland GmbH
 Theodor-Heuss-Strasse 38, 61118 Bad Vilbel; Germany
 +49 6101 80270-0
 Thomas Modenbach; ardeinfo@arworld.us; www.ar-deutschland.com
Produkte und Services: Verstärker, Antennen, Kabel und Stecker, Abgeschirmte Räume und Gehäuse, Überspannung und Einschaltstöße, Testausstattung

Arrow Europe
 Landstraßer Hauptstraße 97-101/Stiege 1 / 4A 1030
 Wien, Österreich
 +43 (0)1 360 46-50; www.arroweurope.com
Produkte und Services: Ferrite, Kabel und Steckverbinder, Power Applications

C

EMCO Elektronik GmbH
 Bunsenstrasse 5, D-82152 Planegg
 +49 (0)89-895565-25
 dwaser@emco-elektronik.de; www.comtest.eu
Products and Services: Absorberhallen, Hallräume, RF geschirmte Räume und Türen, Mikrowelle Absorber

E



EM TEST GmbH
 UEI Universal Elektronik Import GmbH, Anton Freunschlag
 Gasse 49, 1230 Wien, Österreich; +43 1 545 1588;
 Fax: +43 1 545 1464; sales@uei-vienna.com; www.uei-vienna.com
Produkte und Services: Innovative Prüf- und Testsysteme für leitungsgebundene Störfestigkeits-Prüfungen, ESD, Transienten, Harmonics & Flicker, Safetytests, akkreditierte Kalibrierungen, EMV-Prüflabor, Seminare, Workshops, Consulting

F



Fair-Rite Products Corp.
 Industrial Electronics, Hauptstr. 71 - 79 D-65760 Eschborn
 Österreich
 +49 6196 927900; Fax: +49 6196 927929
 w.uhlig@industrialelectronics.de; www.fair-rite.com
Produkte und Services: Ferrit, Filter, Abgeschirmte Räume und Gehäuse, Abschirmung

I



RF/Microwave Amplifiers
IFI - Instruments for Industry
 deg-Messtechnik GmbH
 Meldemannstrasse 18, 1200 Wien
 +43 1 +813 5380-0; Fax: +43 1 813 5380-3059
 info@deg-messtechnik.at; www.deg-messtechnik.at
Produkte und Services: High Power Microwave and RF Amplifiers (Tetrode Tubes, Solid State and TWT) up to 40 GHz

A.H. Systems, inc.

 DRG Horns 178 MHz - 48 GHz 8 Modelle	 Log Periodics 30 MHz - 7 GHz 13 Modelle	 Preamplifiers 20 MHz - 60 GHz 8 Modelle	 Low Loss Cables DC - 40 GHz 4 Modelle
 Biconicals 20 MHz - 330 MHz 5 Modelle	 BiLogicals 25 MHz - 7 MHz 8 Modelle	 Monopoles 100 MHz - 30 MHz 9 Modelle	 Probes 20 Hz - 5 GHz 16 Modelle
 Standard Gain Horns 1 GHz - 40 GHz 8 Modelle	 Loops 20 MHz - 20 MHz 7 Modelle	 H-Field Rods 100 MHz - 20 MHz 4 Modelle	 Antenna Kits 20 Hz - 40 GHz 14 Modelle

Represented by



TEL: 49 7141-2858.20
 FAX: 49 7141-2858.29
<http://www.pn-com.de/>
info@pn-com.de

Austria Germany Switzerland



A.H. Systems
<http://www.AHSystems.com>

M



RF/Microwave Amplifiers

MILMEGA

deg-Messtechnik GmbH Meldemannstrasse 18, 1200 Wien; Österreich; +43 1 +813 5380-0; Fax: +43 1 813 5380-3059; info@deg-messtechnik.at; www.deg-messtechnik.at
Produkte und Services: High Power RF and Microwave solid state amplifiers.
 Frequency range 80MHz up to 6GHz, with output powers to 1kW

O

OMICRON electronics GmbH

Oberes Ried 1 6833 Klaus, AUSTRIA
 +43 5523 507-0; Fax: +43 5523 507-999
 Info@omicon-lab.com; www.omicon-lab.com
Produkte und Services: Test-Sets und Datenerfassungssysteme

R



Rohde & Schwarz Österreich GesmbH.

Technologiestrasse 10, Gebäude E, 1120 Wien

+43 (0) 1 602 61 41-0; Fax +43 (0) 1 602 61 41-14
 rs-austria@rohde-schwarz.com; www.rohde-schwarz.at
 Web-Store: www.rohde-schwarz.at/surf-in
Produkte und Services: EMV Messgeräte und Zubehör, Breitband Leistungsverstärker, EMV Testsoftware, Schlüsselfertige Testsystem-Lösungen

S



Schlegel Electronic Materials

JiC Warenvertriebs-gesellschaft m.b.H., Theresianumgasse 13, Vienna 1040, Österreich
 +43-1-812 2739; Fax: +43-1-812 1081
 John Wellems; john.wellems@jic-trading.com
 www.jic-trading.com
Produkte und Services: Leitungsmaterialien, Abschirmung

T



Advanced Test Solutions for EMC

Teseq

deg-Messtechnik GmbH
 Meldemannstrasse 18, 1200 Wien; Österreich

+43 1 +813 5380-0; Fax: +43 1 813 5380-3059
 info@deg-messtechnik.at; www.deg-messtechnik.at
Produkte und Services: Verstärker (HF & Mikrowellen), Antennen, Automotive Systeme, leitungsgebundene Störfestigkeit, leitungsgebundene Überspannung & schnelle Transienten, ESD, Netzbewellen & Flicker, GTEM Zellen, HF Immunitäts- und Emissionssysteme, HF Testsoftware, Kalibration & Service

W



Würth Elektronik Austria

Gerberweg 6, AT-2320 Schwechat, Österreich
 Tel. +43 (0) 1 707 40 44
 eiSos-austria@we-online.com
Produkte und Services: Ferrit, Kabel und Stecker

X

x.test GmbH

Amalienstraße 48 1130 Wien, Österreich
 01 8778 171 - 0 info@xtest.at
Produkte und Services: HF Signalgeneratoren, Signal- und Spektralanalysatoren, digital test, EMC



EMV-TESTSYSTEME FÜR KFZ – MIT TESEQ AN DER WELTSPITZE

Globale Präsenz, lokaler Service: Mit ihren EMV-Testsystemen für die Automobilelektronik gibt Teseq weltweit den Takt vor. Unsere Pionier- und Führungsrolle in Forschung und Entwicklung sowie das langjährige Engagement in den internationalen Standardisierungs-Organisationen sichern uns das Vertrauen der Automobilindustrie und der Zuliefererbranchen. Diese haben bekommen – abgesichert durch sieben Teseq Kalibrierungs-Zentren und akkreditierte Labs – die Garantie, dass Testsysteme des Branchenleaders den allerneuesten Stand der Technik repräsentieren und höchsten Qualitätskriterien und Kundenansprüchen gerecht werden.

Das Teseq Leistungsspektrum auf einen Blick:

- EMV-Emissionen
- Störfestigkeit
- BCI
- ESD 30 kV
- Transients
- Reverberation
- RF Solutions
- GTEM

Represented by deg-Messtechnik GmbH Wien
 T +43 1 813 5380-0 www.deg-messtechnik.at
 www.teseq.com



PRODUCTS AND SERVICES

Albania

AR / RF Microwave Instrumentation

AR Europe

First Floor Ashling Building, National Technology Park
Limerick, Ireland

+33 628 055 666; Jérôme Surowiec; jsurowiec@arworld.us

Products and Services: Amplifiers, Antennas, Cables and Connectors, Shielded Rooms & Enclosures, Surge & Transients, Test Instrumentation.

Comtest Engineering bv

Industrieweg 12,

2382 NV Zoeterwoude, The Netherlands

+31-71 5417531; Info@comtest.eu; www.comtest.eu

Products and services: Anechoic chambers,

Reverberation chambers, RF shielded rooms & doors, Microwave absorbers.

EMC Partner

ACTA Ltd., Ethnikis Antistaseos 14A,

Chalandri, GR-15232 Athens, Greece

+30 210 600 33 02; Fax: +30 210 600 31 13

Antonis Georgiou; ageo@acta.com.gr

www.acta.com.gr

Products and Services: Surge & Transients, Test Instrumentation

IFI - Instruments for Industry

AMETEK CTS GmbH, Lünener Str. 211, 59174 Kamen, Germany; +

49 2307 26070-0, Fax: +49 2307 17050, sales.cts@ametek.com,

www.ametek-cts.com

Products and Services: High Power Microwave and RF Amplifiers (Tetrode Tubes, Solid State and TWT) up to 40 GHz

MILMEGA

AMETEK CTS GmbH, Lünener Str. 211, 59174 Kamen, Germany; +

49 2307 26070-0, Fax: +49 2307 17050, sales.cts@ametek.com,

www.ametek-cts.com

Products and Services: High Power RF and Microwave solid state amplifiers. Frequency range 80MHz up to 6GHz, with output powers to 1kW

Teseq

AMETEK CTS GmbH, Lünener Str. 211, 59174 Kamen, Germany; +

49 2307 26070-0, Fax: +49 2307 17050, sales.cts@ametek.com,

www.ametek-cts.com

Products and Services: Amplifiers (RF & Microwave),

Antennas, Automotive Systems, Conducted RF immunity, Conducted Surge & Transients, ESD, Harmonics & Flicker, GTEM cells, RF Immunity Systems, RF Emission Systems, RF Testsoftware, Calibration & Service

Armenia

EM TEST

EMCI, 105005, Radio Str., 24, Build. 1 (office), Moskau, Russland;

+7 (495) 410 64 65; Fax: +7 (495) 980 71 19; info@emci.ru;

www.emci.ru

Products and Services: Innovative test- and measurementsystems für conducted immunity tests, ESD, transients, automotive, harmonics & flicker, AC/DC-sources, safetytest systems, accredited calibrations, seminars, workshops, consulting

IFI - Instruments for Industry

AMETEK CTS GmbH, Lünener Str. 211, 59174 Kamen, Germany; +

49 2307 26070-0, Fax: +49 2307 17050, sales.cts@ametek.com,

www.ametek-cts.com

Products and Services: High Power Microwave and RF Amplifiers (Tetrode Tubes, Solid State and TWT) up to 40 GHz

MILMEGA

AMETEK CTS GmbH, Lünener Str. 211, 59174 Kamen, Germany; +

49 2307 26070-0, Fax: +49 2307 17050, sales.cts@ametek.com,

www.ametek-cts.com

Products and Services: High Power RF and Microwave solid state amplifiers.

Frequency range 80MHz up to 6GHz, with output powers to 1kW

Teseq

AMETEK CTS GmbH, Lünener Str. 211, 59174 Kamen, Germany; +

49 2307 26070-0, Fax: +49 2307 17050, sales.cts@ametek.com,

www.ametek-cts.com

Products and Services: Amplifiers (RF & Microwave), Antennas, Automotive Systems, Conducted RF immunity, Conducted Surge & Transients, ESD, Harmonics & Flicker, GTEM cells, RF Immunity Systems, RF Emission Systems, RF Testsoftware, Calibration & Service

Belarus

AR RF/Microwave Instrumentation

Radiant-Elcom, 117246, Nautchny proezd,

8 b.1, Moscow;

+7495 725 0404; Fax: +7495 921 3585

Sergey Pavlov, ps@ranet.ru; www.radiant-su

Products and Services: Amplifiers, Antennas, Cables & Connectors, Shielded Rooms & Enclosures, Surge & Transients, Test Instrumentation

Comtest - EMCI

Moscow, Russia

+7 495 410-6465; Mikhael Kuznetsov

info@EMCI.ru; www.comtest.eu

Products and services: Anechoic chambers, Reverberation chambers, RF shielded rooms & doors, Microwave absorbers.

EM TEST

EMCI, 105005, Radio Str., 24, Build. 1 (office), Moskau, Russland;

+7 (495) 410 64 65; Fax: +7 (495) 980 71 19; info@emci.ru;

www.emci.ru

Products and Services: Innovative test- and measurementsystems für conducted immunity tests, ESD, transients, automotive, harmonics & flicker, AC/DC-sources, safetytest systems, accredited calibrations, seminars, workshops, consulting

IFI - Instruments for Industry

AMETEK CTS GmbH, Lünener Str. 211, 59174 Kamen, Germany; +

49 2307 26070-0, Fax: +49 2307 17050, sales.cts@ametek.com,

www.ametek-cts.com

Products and Services: High Power Microwave and RF Amplifiers (Tetrode Tubes, Solid State and TWT) up to 40 GHz

MILMEGA

AMETEK CTS GmbH, Lünener Str. 211, 59174 Kamen, Germany; +

49 2307 26070-0, Fax: +49 2307 17050, sales.cts@ametek.com,

www.ametek-cts.com

Products and Services: High Power RF and Microwave solid state amplifiers. Frequency range 80MHz up to 6GHz, with output powers to 1kW

Teseq

AMETEK CTS GmbH, Lünener Str. 211, 59174 Kamen, Germany; +

49 2307 26070-0, Fax: +49 2307 17050, sales.cts@ametek.com,

www.ametek-cts.com

Products and Services: Amplifiers (RF & Microwave), Antennas, Automotive Systems, Conducted RF immunity, Conducted Surge & Transients, ESD, Harmonics & Flicker, GTEM cells, RF Immunity Systems, RF Emission Systems, RF Testsoftware, Calibration & Service

Bosnia- Herzegovina

EM TEST GmbH

Tetra doo Beograd; Begejska 2a, 11050 Belgrade, + 381 11 2894

424; Fax + 381 11 3049640; office@tetra.co.rs; www.tetra.co.rs

Products and Services: Innovative test- and measurementsystems für conducted immunity tests, ESD, transients, automotive, harmonics & flicker, AC/DC-sources, safetytest systems, accredited calibrations, seminars, workshops, consulting

IFI - Instruments for Industry

AMETEK CTS GmbH, Lünener Str. 211, 59174 Kamen, Germany; +

49 2307 26070-0, Fax: +49 2307 17050, sales.cts@ametek.com,

www.ametek-cts.com

Products and Services: High Power Microwave and RF Amplifiers (Tetrode Tubes, Solid State and TWT) up to 40 GHz

MILMEGA

AMETEK CTS GmbH, Lünener Str. 211, 59174 Kamen, Germany; +

49 2307 26070-0, Fax: +49 2307 17050, sales.cts@ametek.com,

www.ametek-cts.com

Products and Services: High Power RF and Microwave solid state amplifiers. Frequency range 80MHz up to 6GHz, with output powers to 1kW

Teseq

AMETEK CTS GmbH, Lünener Str. 211, 59174 Kamen, Germany; +

49 2307 26070-0, Fax: +49 2307 17050, sales.cts@ametek.com,

www.ametek-cts.com

Products and Services: Amplifiers (RF & Microwave), Antennas, Automotive Systems, Conducted RF immunity, Conducted Surge & Transients, ESD, Harmonics & Flicker, GTEM cells, RF Immunity Systems, RF Emission Systems, RF Testsoftware, Calibration & Service

Bulgaria

A.H. Systems, Inc.

Test Solutions, Sofia;

+359 2 970 1990; Fax: +359 2 970 1999;

dobromil_dobrev@testolutions.bg; www.testolutions.bg

Products and Services: Antennas,

Test Instrumentation, Testing

AR RF/Microwave Instrumentation

AR Europe

First Floor Ashling Building, National Technology Park

Limerick, Ireland

+33 628 055 666; Jérôme Surowiec; jsurowiec@arworld.us

Products and Services: Amplifiers, Antennas, Cables & Connectors, Shielded Rooms & Enclosures, Surge & Transients, Test Instrumentation

Comtest - Test Solutions

Sofia, Bulgaria +359 2 970 1990

Dobromil Dobrev; Dobromil_Dobrev@testolutions.bg;

www.comtest.eu

Products and services: Anechoic chambers, Reverberation chambers, RF shielded rooms & doors, Microwave absorbers.

EM TEST GmbH

AMETEK CTS GmbH, Lünener Str. 211, 59174 Kamen, Germany; +

49 2307 26070-0, Fax: +49 2307 17050, sales.cts@ametek.com,

www.ametek-cts.com

Products and Services: Innovative test- and measurementsystems für conducted immunity tests, ESD, transients, automotive, harmonics & flicker, AC/DC-sources, safetytest systems, accredited calibrations, seminars, workshops, consulting

EMC Partner AG

+41 61 775 20 30;

Nicolas Wright; sales@emc-partner.ch;

www.emc-partner.ch

Products and Services: Surge & Transients, Test Instrumentation

IFI - Instruments for Industry

Balkantel Ltd., 68, Bratya Bakston Blvd., Sofia 1618,

+359 2 850 04 30; Fax +359 2 955 91 89;

mail@balkantel.net; www.balkantel.net

Products and Services: High Power Microwave and RF Amplifiers (Tetrode Tubes, Solid State and TWT) up to 40 GHz

MILMEGA

Balkantel Ltd., 68, Bratya Bakston Blvd., Sofia 1618,

+359 2 850 04 30; Fax +359 2 955 91 89

mail@balkantel.net; www.balkantel.net

Products and Services: High Power RF and Microwave solid state amplifiers. Frequency range 80MHz up to 6GHz, with output powers to 1kW

Rohde & Schwarz

Österreich Ges.m.b.H. Representative Office Sofia
8, Milloserdna Str. 1463 Sofia Bulgaria
+359 2 9542882; +359 2 9542992
www.rohde-schwarz.com
http://shop.rohde-schwarz.com/cee
Products and Services: EMV Test Equipment and Accessories; Broadband Amplifiers; EMC Test Software; Turnkey Test System Solutions

Teseq

Balkantel Ltd., 68, Bratya Bakston Blvd., Sofia 1618,
+359 2 850 04 30; Fax +359 2 955 91 89;
mail@balkantel.net; www.balkantel.net
Products and Services: Amplifiers, Antennas, Automotive Systems, Conducted RF immunity, Conducted Surge & Transients, ESD, Harmonics & Flicker, GTEM cells, RF Immunity Systems, RF Emission Systems, RF Testsoftware, Calibration & Service

Cyprus

AR RF/Microwave Instrumentation

Vector Technologies, 40, Diogenos str. Halandri, 15234 Greece;
+30 210 685 80 08; Fax: +30 210 685 81 18
Geroge Koukas, info@vectortechnologies.gr
www.vectortechnologies.gr
Products and Services: Amplifiers, Antennas, Cables & Connectors, Shielded Rooms & Enclosures, Surge & Transients, Test Instrumentation

EMC Partner

ACTA Ltd., Ethnikis Antistaseos 14A,
Chalandri, GR-15232 Athens, Greece
+30 210 600 33 02; Fax: +30 210 600 31 13
Antonis Georgiou, ageo@acta.com.gr; www.acta.com.gr
Products and Services: Surge & Transients, Test Instrumentation

IFI - Instruments for Industry

DRYS TECHNIKI S.A.,
13 Thessalonikis str., 18346 Moschato;
+30 210 523 2842; Fax +30 210 52 32 555
drysales@drystech.gr; www.drystech.gr
Products and Services: High Power Microwave and RF Amplifiers (Tetrode Tubes, Solid State and TWT) up to 40 GHz

MILMEGA

DRYS TECHNIKI S.A.,
13 Thessalonikis str., 18346 Moschato;
+30 210 523 2842; Fax +30 210 52 32 555
drysales@drystech.gr; www.drystech.gr
Products and Services: High Power RF and Microwave solid state amplifiers. Frequency range 80MHz up to 6GHz, with output powers to 1kW

Teseq

DRYS TECHNIKI S.A.,
13 Thessalonikis str., 18346 Moschato;
+30 210 523 2842; Fax +30 210 52 32 555;
drysales@drystech.gr; www.drystech.gr
Products and Services: Amplifiers (RF & Microwave), Antennas, Automotive Systems, Conducted RF immunity, Conducted Surge & Transients, ESD, Harmonics & Flicker, GTEM cells, RF Immunity Systems, RF Emission Systems, RF Testsoftware, Calibration & Service

Czech Republic

AR RF/Microwave Instrumentation

H TEST a.s., Safránkova 3,15500 Praha 5 Czech Republic; +420 235365207; Fax: +420 23536889;
David Koshuba; www.htest.cz
Products and Services: Amplifiers, Antennas, Cables & Connectors, Shielded Rooms & Enclosures, Surge & Transients, Test Instrumentation

Comtest - Probin

Prague, Czech republic
+420 221451370 Thomas Rathousky;
rathousky@probin.cz; www.comtest.eu
Products and services: Anechoic chambers, Reverberation chambers, RF shielded rooms & doors, Microwave absorbers.

CST AG, Branch Office Prague

Pražska 636, 25241 Dolní Brezany, Czech Republic
+420 257 219 488; vratislav.sokol@cst.com; www.cst.com
Products and Services: Testing, antennas, shielding, cable, software, plugs

EM TEST

Testovaci Technika s.r.o., Hakenova 1423, 290 01 Pobebrady, Tschechische Republik; +42 325 610 123; Fax: +42 325 610 134; teste@teste.cz; www.teste.cz
Products and Services: Innovative test- and measurementsystems

für conducted immunity tests, ESD, transients, automotive, harmonics & flicker, AC/DC-sources, safetytest systems, accredited calibrations, seminars, workshops, consulting

EMC Partner

TECTRA A.S., Domkova 234/43,
CZ-193 00 Praha, Czech Republic
+420 281 921 650; Fax: +420 281 921 649
Herr Ing. Zbynek Sommer, tectra@tectra.cz;
www.tectra.cz
Products and Services: Surge & Transients, Test Instrumentation

IFI – Instruments for Industry

Empos Spol s.r.o., U Novych Vil 18, 10000 Praha 10,
+420 2 4174 2084; Fax +420 4174 2088;
info@empos.cz; www.empos.cz
Products and Services: High Power Microwave and RF Amplifiers (Tetrode Tubes, Solid State and TWT) up to 40 GHz

MILMEGA

Empos Spol s.r.o., U Novych Vil 18, 10000 Praha 10,
+420 2 4174 2084; Fax +420 4174 2088;
info@empos.cz; www.empos.cz
Products and Services: High Power RF and Microwave solid state amplifiers. Frequency range 80MHz up to 6GHz, with output powers to 1kW

SCHURTER spol. s.r.o

Malá Skála 190, 46822 Zelezný Brod
+42 0483 392 080
firma@schurter.cz; www.schurter.cz
Products and Services: Filters, Shielding

TDK RF Solutions

Aktif Nesor Elektronik
Kayisdagi Cad. Atayol Plaza, No:45 Kat:5 D:11-12
34750 Atasehir Istanbul, Turkey
+90 (216) 577 6 999;
neslihan@aktifneser.com.tr; www.tdkrfolutions.com
Products and Services: Antennas, Filters, Software, Testing services

Teseq

Empos Spol s.r.o., U Novych Vil 18, 10000 Praha 10,
+420 2 4174 2084; Fax +420 4174 2088
info@empos.cz; www.empos.cz
Products and Services: Amplifiers, Antennas, Automotive Systems, Conducted RF immunity, Conducted Surge & Transients, ESD, Harmonics & Flicker, GTEM cells, RF Immunity Systems, RF Emission Systems, RF Test software, Calibration & Service

Würth Elektronik Czech Republic

Nad Vyzovem 4857, CZ-760 05 Zlín
Tel. +420 577 001 981; eiSos-czech@we-online.com
Products and Services: Cables & Connectors, Ferrites

Denmark

AR RF/Microwave Instrumentation

Compomill Denmark, Ndr. Fasanvej 224
2200 KØBENHAVN, Denmark
+45 (0) 44 84 87 00; Fax: +45 (0) 44 84 00 69
info@compomill.com
Products and Services: Amplifiers, Antennas, Cables & Connectors, Shielded Rooms & Enclosures, Surge & Transients, Test Instrumentation

Bolls ApS

Ved Gadekæret 11F, DK-3660 Stenløse, Denmark
+45 48 18 35 66
www.bolls.dk; info@bolls.dk
Products & Services: Consultants, Full EMC test facilities and CE typetest

Comtest Engineering bv

Industrieweg 12, 2382 NV Zoeterwoude, The Netherlands
+31-71 5417531; Info@comtest.eu; www.comtest.eu
Products and services: Anechoic chambers, Reverberation chambers, RF shielded rooms & doors, Microwave absorbers.

Erik Blichfeld A/S

PO Box 400, Kolding, Kolding, DK-6000, Denmark
+45 75 52 20 20; Fax: +45 75 56 70 07
Henrik Andresen, info@blichfeld.dk; www.blichfeld.dk
Products & Services: Amplifiers, Antennas, Filters, Surge & Transients

EM TEST

Nortelco Electronics Denmark, Vaerkstedsgarden 14, 1, 2620 Albertslund, Denmark; +45 48 17 75 00; Fax: +45 48 17 75 10; elektronik@nortelco.dk; www.nortelcoelectronics.dk

Products and Services: Innovative test- and measurementsystems für conducted immunity tests, ESD, transients, automotive, harmonics & flicker, AC/DC-sources, safetytest systems, accredited calibrations, seminars, workshops, consulting

EMC Partner

ERDE- ELEKTRONIK AB, Spikgatan 8,
SE-23532 Vellinge, Sweden
+46 40 42 46 10; Fax: +46 40 42 62 18
Ralf Danielsson; info@erde.se; www.erde.se
Products and Services: Surge & Transients, Test Instrumentation

IFI - Instruments for Industry

AMETEK CTS GmbH, Lünener Str. 211, 59174 Kamen, Germany;
+49 2307 26070-0, Fax: +49 2307 17050, www.ametek-cts.com
Products and Services: High Power Microwave and RF Amplifiers (Tetrode Tubes, Solid State and TWT) up to 40 GHz

Langer EMV-Technik GmbH

Erik Blichfeld A/S, Box 400, Birkemosevej 11,
DK-6000 KOLDING
+45 755 22020; Fax: +45 755 67007
Erik Blichfeld; info@blichfeld.dk; www.blichfeld.dk
Products and Services: Test Instrumentation

MILMEGA

Erik Blichfeld A/S, Birkemosevej 11, 6000 Kolding; +45 75 52 20 20, Fax +45 75 56 70 07; info@blichfeld.dk; www.blichfeld.dk
Products and Services: High Power RF and Microwave solid state amplifiers. Frequency range 80MHz up to 6GHz, with output powers to 1kW

Rohde & Schwarz Danmark A/S

Ejby Industrivej 40, 2600 Glostrup
+45 (0) 43 43 66 99; Fax +45 (0) 43 43 77 44
info.rsdk@rohde-schwarz.com; www.rohde-schwarz.dk; Web Store: www.rohde-schwarz.dk/surf-in
Products and Services: EMC Test Equipment and Accessories, Broadband Amplifiers, EMC Test Software, Turnkey Test System Solutions

Schlegel Electronic Materials

BOMBERG & CO. ApS, Vassingerdvej 145,
DK 3540 Lyngø, Denmark
+45 48140155; Fax: +45 48140156
Evan Stæhr; info@bomberg.com; www.bomberg.com
Products and services: Conductive materials, shielding

Tech-Etch, Inc.

BOMBERG & CO. ApS, Vassingerdvej 145, 3540 Lyngø, CVR Nr. 27306179 Denmark
+45 48 14 01 55; Fax: +45 48 14 01 56
sales@bomberg.com; www.techetch.com
Products and Services: Conductive Materials, Shielding

Teseq

Erik Blichfeld A/S, Birkemosevej 11, 6000 Kolding;
+45 75 52 20 20, Fax +45 75 56 70 07
info@blichfeld.dk; www.blichfeld.dk
Products and Services: Amplifiers (RF & Microwave), Antennas, Automotive Systems, Conducted RF immunity, Conducted Surge & Transients, ESD, Harmonics & Flicker, GTEM cells, RF Immunity Systems, RF Emission Systems, RF Testsoftware, Calibration & Service

Estonia

AR RF/Microwave Instrumentation

Compomill Finland,
Riihitontuntie 2, 02200 ESPOO
+358 (0) 9 524470; Fax: +358 (0)9 524471
info@compomill.com
Products and Services: Amplifiers, Antennas, Cables & Connectors, Shielded Rooms & Enclosures, Surge & Transients, Test Instrumentation

Comtest Engineering bv

Industrieweg 12, 2382 NV Zoeterwoude, The Netherlands;
+31-71 5417531
Info@comtest.eu; www.comtest.eu
Products and services: Anechoic chambers, Reverberation chambers, RF shielded rooms & doors, Microwave absorbers.

EMC Partner

ASTAT sp. zo.o, ul. Dabrowskiego 441,
PL-60 451 Poznan, Poland
+48 61 849 80 61; Fax: +48 61 848 82 76
Lukasz Wilk; l.wilk@astat.com.pl; www.astat.com.pl
Products and Services: Surge & Transients, Test Instrumentation

EM TEST

Amitronic Oy, Tarmontie 2, 15860 Hollola, Finland; +358 10 231 8800; Fax: +358 3 751 0253; sales@amitronic.fi; www.amitronic.fi
Products and Services: Innovative test- and measurements systems for conducted immunity tests, ESD, transients, automotive, harmonics & flicker, AC/DC-sources, safety test systems, accredited calibrations, seminars, workshops, consulting

IFI - Instruments for Industry

AMETEK CTS GmbH, Lünener Str. 211, 59174 Kamen, Germany; +49 2307 26070-0; Fax: +49 2307 17050, www.ametek-cts.com
Products and Services: High Power Microwave and RF Amplifiers (Tetrode Tubes, Solid State and TWT) up to 40 GHz.

MILMEGA

AMETEK CTS GmbH, Lünener Str. 211, 59174 Kamen, Germany; +49 2307 26070-0; Fax: +49 2307 17050, www.ametek-cts.com
Products and Services: High Power RF and Microwave solid state amplifiers. Frequency range 80MHz up to 6GHz, with output powers to 1kW

Teseq

AMETEK CTS GmbH, Lünener Str. 211, 59174 Kamen, Germany; +49 2307 26070-0; Fax: +49 2307 17050, www.ametek-cts.com
Products and Services: Amplifiers, Antennas, Automotive Systems, Conducted RF Immunity, Conducted Surge & Transients, ESD, Harmonics & Flicker, GTEM cells, RF Immunity Systems, RF Emission Systems, RF Testsoftware, Calibration & Service

Würth Elektronik

Enghave Park 61, DK-3450 Allerød, Denmark
 Tel. +45 227 052 00
 eiSos-scandinavia@we-online.com
Products and Services: Cables & Connectors, Ferrites

Finland**AR RF/Microwave Instrumentation**

Compomill Finland,
 Riihitontuntie 2, 02200 ESPOO
 +358 (0) 9 524470; Fax: +358 (0) 9 524471
 info@compomill.com

Products and Services: Amplifiers, Antennas, Cables & Connectors, Shielded Rooms & Enclosures, Surge & Transients, Test Instrumentation

Comtest- Amitronic Oy

Lahti, Finland
 +358 10 231 8800
 Keijo Hokkanen; sales@amitronic.fi; www.comtest.eu
Products and services: Anechoic chambers, Reverberation chambers, RF shielded rooms & doors, Microwave absorbers.

EM TEST

Amitronic Oy, Tarmontie 2, 15860 Hollola, Finland; +358 10 231 8800; Fax: +358 3 751 0253; sales@amitronic.fi; www.amitronic.fi
Products and Services: Innovative test- and measurements systems for conducted immunity tests, ESD, transients, automotive, harmonics & flicker, AC/DC-sources, safety test systems, accredited calibrations, seminars, workshops, consulting

EMC Partner

INEL Ltd. Oy, Graniittitie 9, FI-00710 Helsinki, Finland;
 +358 10 42 37 570; Fax: +358 10 42 37 579;
 Raimo Sainio, inel@inel.fi; www.inel.fi
Products and Services: Surge & Transients, Test Instrumentation

ETS-Lindgren

Mekaanikontie 1, 27510 Eura, Finland;
 +358 2 8383 300; Fax: +358 2 8651 233;
 euinfo@etslindgren.com
Products and Services: Antennas, Ferrites, Filters, Shielded Rooms & Enclosures, RFI/EMI Signal Generators, Test Instrumentation, Miscellaneous

Fair-Rite

Caltest Oy, Kaarelantie 21 FIN-00430 Helsinki;
 +358 95 30 6070; Fax: +358 95 30 60 711;
 info@caltest.fi
Products and Services: Antennas, Ferrites

IFI - Instruments for Industry

Metric Industrial Oy, Postbox 14, Piispantilankuja 4, 02241 Espoo;
 +358 9 4761 600; Fax: +358 9 4761 6700; sales@metric.fi; www.metricindustrial.com
Products and Services: High Power Microwave and RF Amplifiers (Tetrode Tubes, Solid State and TWT) up to 40 GHz

Langer EMV-Technik GmbH

INEL Ltd. Oy, PO Box 14, FIN-00711 Helsinki
 +358 10 423 757-0; Fax: +358 10 423 757-9
 inel@inel.fi; www.inel.fi
Products and Services: Test Instrumentation

MILMEGA

Exova METECH Oy, Kuormakujia 1, FIN-03100, Nummela
 +358 40 03 56 054; Fax: +358 95 84 00 552
 Virpi.Marttila@exova.com; www.exovametech.fi
Products and Services: High Power RF and Microwave solid state amplifiers. Frequency range 80MHz up to 6GHz, with output powers to 1kW

TDK Electronics Finland

Tykistökatu 6
 FIN-20520 Turku, Finland
 +358 (0) 20 7281680; info@tdkrf.com;
 www.tdkrfsolutions.com
Products and Services: Antennas, Filters, Software, Testing services

Rohde & Schwarz Finland Oy

Taivaltie 5, 01610 VANTAA
 +358 (0) 207 600 400; Fax: +358 (0) 207 600 417
 info.rsfin@rohde-schwarz.com; www.rohde-schwarz.fi;
 Web Store: www.rohde-schwarz.fi/surf-in
Products and Services: EMC Test Equipment and Accessories, Broadband Amplifiers, EMC Test Software, Turnkey Test System Solutions

Schlegel Electronic Materials

Amitronic Oy, Tarmontie 2, FI-15860 Hollola, Finland
 +358 10 231 8800; Fax: +358 3 751 0253;
 Mobile: +358 500 811600
 Keijo Hokkanen, keijo.hokkanen@amitronic.fi;
 www.amitronic.fi
Products and services: Conductive materials, shielding

Teseq

Metric Industrial Oy,
 Postbox 14, Piispantilankuja 4, 02241 Espoo
 +358 9 4761 600; Fax: +358 9 4761 6700
 sales@metric.fi; www.metricindustrial.com
Products and Services: Amplifiers (RF & Microwave), Antennas, Automotive Systems, Conducted RF immunity, Conducted Surge & Transients, ESD, Harmonics & Flicker, GTEM cells, RF Immunity Systems, RF Emission Systems, RF Testsoftware, Calibration & Service

Würth Elektronik Finland Oy

Karhutie 4, FIN-01900 Nurmijärvi
 +358 (0) 9 8789 00; eiSos-finland@we-online.com
Products and Services: Cables & Connectors, Ferrites

Greece**A.H. Systems, Inc.**

Vector Technologies, Athens;
 +302106858008; Fax: +302106858118
 info@vectortechnologies.gr; www.vectortechnologies.gr
Products and Services: Antennas, Test Instrumentation, Testing

AR RF/Microwave Instrumentation

Vector Technologies, 40,
 Diogenous str. Halandri, 15234 Greece
 +30 210 6858008; Fax: +30 210 6858118
 Geroge Koukas, info@vectortechnologies.gr
 www.vectortechnologies.gr
Products and Services: Amplifiers, Antennas, Cables & Connectors, Shielded Rooms & Enclosures, Surge & Transients, Testing

EM TEST

MES Ltd., 228, Kifissias Ave., 14561 Kifissia, Greece; +30(0210)80 16 077; Fax: +30(0210)80 16 034; dpmkour@otenet.gr
Products and Services: Innovative test- and measurement systems for conducted immunity tests, ESD, transients, automotive, harmonics & flicker, AC/DC-sources, safety test systems, accredited calibrations, seminars, workshops, consulting

EMC Partner

ACTA Ltd., Ethnikis Antistaseos 14A, Chalandri,
 GR-15232 Athens, Greece
 +30 210 600 33 02; Fax: +30 210 600 31 13
 Antonis Georgiou, ageo@acta.com.gr; www.acta.com.gr
Products and Services: Surge & Transients, Test Instrumentation

IFI – Instruments for Industry

DRYS TECHNIKI S.A., 13 Thessalonikis Str., 18346 Moschato;
 +30 210 523 2842; Fax: +30 210 52 32 555
 drysales@drystech.gr; www.drystech.gr
Products and Services: High Power Microwave and RF Amplifiers (Tetrode Tubes, Solid State and TWT) up to 40 GHz

MILMEGA

DRYS TECHNIKI S.A., 13 Thessalonikis Str.,
 18346 Moschato; +30 210 523 2842; Fax: +30 210 52 32 555
 drysales@drystech.gr; www.drystech.gr
Products and Services: High Power RF and Microwave solid state

amplifiers. Frequency range 80MHz up to 6GHz, with output powers to 1kW

Teseq

DRYS TECHNIKI S.A.,
 13 Thessalonikis str., 18346 Moschato;
 +30 210 523 2842; Fax: +30 210 52 32 555;
 drysales@drystech.gr; www.drystech.gr
Products and Services: Amplifiers (RF & Microwave), Antennas, Automotive Systems, Conducted RF immunity, Conducted Surge & Transients, ESD, Harmonics & Flicker, GTEM cells, RF Immunity Systems, RF Emission Systems, RF Testsoftware, Calibration & Service

Vector Technologies Ltd

40 Diogenous str, Halandri, Athens 15234, Greece;
 Panos Vouvonas, info@vectortechnologies.gr;
 www.vectortechnologies.gr
Products & Services: Test Instrumentation, Amplifiers, Antennas

Hungary**AR RF/Microwave Instrumentation**

H TEST Hungary Kft.
 Gyor Nemzetközi Ipari Park, Gesztenyefa u. 4,
 H-9027 Gyor, Hungary
 +36 96 999 262; Erika Németh; info@hstest.hu
Products and Services: Amplifiers, Antennas, Cables & Connectors, Shielded Rooms & Enclosures, Surge & Transients, Test Instrumentation

Comtest - H TEST Hungary Kft.

H-9027 Győr, Hungary
 +36 202649208; Jozef Ambrozai; info@hstest.hu
 www.comtest.eu
Products and services: Anechoic chambers, Reverberation chambers, RF shielded rooms & doors, Microwave absorbers.

EMC Partner

ELTEST Kft, Hattytó u.16, HU-1015 Budapest, Hungary
 +36 1 202 1873; Fax: +36 1 225 00 31
 Janos Redai, eltest@eltest.hu; www.eltest.hu
Products and Services: Surge & Transients, Test Instrumentation

EM TEST

Promet Merestechnika Kft, Arany Janos u. 54, 2314 Halasztelek, Hungary; +36 24 521 240; Fax: +36 (0)24 521 253; promet@promet.hu; www.promet.hu
Products and Services: Innovative test- and measurements systems for conducted immunity tests, ESD, transients, automotive, harmonics & flicker, AC/DC-sources, safety test systems, accredited calibrations, seminars, workshops, consulting

TDK Elektronika Magyarország Kft.

Madarász Viktor u. 47-49
 H-1138 Budapest, Hungary
 +36-(1)4360720; info@tdkrf.com;
 www.tdkrfsolutions.com
Products and Services: Antennas, software, testing

IFI – Instruments for Industry

Tetra Electronics Kft.
 Mikszath Kalman u. 105, 1184 Budapest
 +36 1 291 2065; Fax: +36 1 291 1643
 tetra@tetra.hu; www.tetra.hu
Products and Services: High Power Microwave and RF Amplifiers (Tetrode Tubes, Solid State and TWT) up to 40 GHz

MILMEGA

Tetra Electronics Kft., Mikszath Kalman u. 105,
 1184 Budapest,
 +36 1 291 2065; Fax: +36 1 291 1643
 tetra@tetra.hu; www.tetra.hu
Products and Services: High Power RF and Microwave solid state amplifiers. Frequency range 80MHz up to 6GHz, with output powers to 1kW

Rohde & Schwarz

Österreich Ges.m.b.H. - Budapesti Iroda
 Madarász Viktor utca 47-49.
 1138 Budapest, Hungary
 +36 1 4124460; Fax: +36 1 4124461
 www.rohde-schwarz.com
 http://shop.rohde-schwarz.com/cee
Products and Services: EMC Test Equipment and Accessories; Broadband Amplifiers; EMC Test Software; Turnkey Test System Solutions

Teseq

Tetra Electronics Kft., Mikszath Kalman u. 105,
 1184 Budapest, +36 1 291 2065; Fax: +36 1 291 1643; tetra@tetra.hu; www.tetra.hu

Products and Services: Amplifiers, Antennas, Automotive Systems, Conducted RF immunity, Conducted Surge & Transients, ESD, Harmonics & Flicker, GTEM cells, RF Immunity Systems, RF Emission Systems, RF Testsoftware, Calibration & Service

Würth Elektronik Hungary

Csitári u. 17, HU-1162 Budapest, Hungary
Tel. +36 1 7878 197; eiSos-hungary@we-online.com
Products and Services: Cables & Connectors, Ferrites

Ireland

AR RF/Microwave Instrumentation

Unit 8 TORC MK, Chippenham Drive, Kingston, Milton Keynes, England Bucks MK10 OAE
+44(1) 908 282766; +44(1) 908 288249
Mark Reeve, Mreeve@arworld.us; www.arukltd.co.uk
Products and Services: Amplifiers, Antennas, Cables & Connectors, Shielded Rooms & Enclosures, Surge & Transients, Test Instrumentation

Compliance Engineering Ireland Ltd.

Clonross, Dunshaughlin, Co Meath
+353 18017000; Fax: +353 1 8256733
john.mcauley@cei.ie
Products and Services: Accredited Testing, Surge and Transients, Notified Body Services

EM TEST

Frequensys Ltd., 10 Abbey Court, Fraser Road, MK44 3WH Bedford, United Kingdom; +44 1142 353 507; Fax: +44 1234 831 998; info@frequensys.co.uk; www.frequensys.co.uk
Products and Services: Innovative test- and measurementsystems für conducted immunity tests, ESD, transients, automotive, harmonics & flicker, AC/DC-sources, safetytest systems, accredited calibrations, seminars, workshops, consulting

EMC Partner (UK) Ltd.

1A Golf Link Villas- The Common Downley- High Wycombe, GB-HP13 5YH Buckinghamshire, United Kingdom
+44(0) 1494 44 42 55; Fax: +44(0) 1494 44 42 77
David Castle; sales@emcpartner.co.uk; www.emcpartner.co.uk
Products and Services: Surge & Transients, Test Instrumentation

IFI - Instruments for Industry

DM Systems and Test, Ltd., 60 Wilbury Way Hitchin Hertfordshire SG4 0/A;
+44 (0) 1462 477277; Fax +44 (0) 1462 428995;
Brian Epton; brian.epton@dplum.co.uk
Graham Howard, graham.howard@dplum.co.uk
Mick Keryell, mike.keryell@dplum.co.uk
Products and Services: High Power Microwave and RF Amplifiers (Tetrode Tubes, Solid State and TWT) up to 40 GHz

MILMEGA

Teseq Ltd., Ashville Way, Molly Millars Lane, Wokingham, Berkshire RG41 2PL; +44 (0) 8540 740 660; Fax: +44 (0) 845 074 0656; uksales@teseq.com; www.ametek-cts.com
Products and Services: High Power RF and Microwave solid state amplifiers. Frequency range 80MHz up to 6GHz, with output powers to 1kW

Rohde & Schwarz

Area Representative Ireland
+ 353 (0) 1 836 17 86
contact.uk@rohde-schwarz.com www.rohde-schwarz.co.uk
Web-Store: www.rohde-schwarz.co.uk/surf-in
Products and Services: EMC Test Equipment and Accessories, Broadband Amplifiers, EMC Test Software, Turnkey Test System Solutions

Schlegel Electronic Materials

EMC Solutions
Father Griffin Road, The Claddagh, Galway City., Ireland
+353 86 2535199; michael.moore@emc-solutions.com, www.emc-solutions.com
Products and services: Conductive materials, shielding

Teseq

Teseq Ltd., Ashville Way, Molly Millars Lane, Wokingham, Berkshire RG41 2PL; +44 (0) 8540 740 660; Fax: +44 (0) 845 074 0656; uksales@teseq.com; www.ametek-cts.com
Products and Services: Amplifiers (RF & Microwave), Antennas, Automotive Systems, Conducted RF immunity, Conducted Surge & Transients, ESD, Harmonics & Flicker, GTEM cells, RF Immunity Systems, RF Emission Systems, RF Testsoftware, Calibration & Service

Würth Elektronik Ireland UK Limited

36, Westbury Drive, Lucan, IRL - Co. Dublin, Ireland
Tel. +353 (0) 1 621 20 61; eiSos-ireland@we-online.com
Products and Services: Cables & Connectors, Ferrites

Latvia

AR RF/Microwave Instrumentation

SIA "SKAILOKS"
SIA Skailoks, Brīvības gatve, 280-1, Rīga, LV-1006, Latvija
+371 67801681; Eriks Kronbergs; office@skailoks.lv
Products and Services: Amplifiers, Antennas, Cables & Connectors, Shielded Rooms & Enclosures, Test Instrumentation

Comtest - UAB Lokmis

Vilnius, Lithuania
+370 5 215 1895;
Saulius Steponavicius; saulius.s@lokmis.lt; www.comtest.eu
Products and services: Anechoic chambers, Reverberation chambers, RF shielded rooms & doors, Microwave absorbers.

EMC Partner

ASTAT sp. zo.o., ul. Dabrowskiego 441, PL-60 451 Poznan, Poland
+48 61 849 80 61; Fax: +48 61 848 82 76
Lukasz Wilk, l.wilk@astat.com.pl; www.astat.com.pl
Products and Services: Surge & Transients, Test Instrumentation

IFI – Instruments for Industry

AMETEK CTS GmbH, Lünener Str. 211, 59174 Kamen, Germany; +49 2307 26070-0, Fax: +49 2307 17050, sales.cts@ametek.com, www.ametek-cts.com
Products and Services: High Power Microwave and RF Amplifiers (Tetrode Tubes, Solid State and TWT) up to 40 GHz

MILMEGA

AMETEK CTS GmbH, Lünener Str. 211, 59174 Kamen, Germany; +49 2307 26070-0, Fax: +49 2307 17050, sales.cts@ametek.com, www.ametek-cts.com
Products and Services: High Power RF and Microwave solid state amplifiers. Frequency range 80MHz up to 6GHz, with output powers to 1kW

Teseq

AMETEK CTS GmbH, Lünener Str. 211, 59174 Kamen, Germany; +49 2307 26070-0, Fax: +49 2307 17050, sales.cts@ametek.com, www.ametek-cts.com
Products and Services: Amplifiers (RF & Microwave), Antennas, Automotive Systems, Conducted RF immunity, Conducted Surge & Transients, ESD, Harmonics & Flicker, GTEM cells, RF Immunity Systems, RF Emission Systems, RF Testsoftware, Calibration & Service

Lithuania

AR RF/Microwave Instrumentation

UAB "LOKMIS"
Visoriu str.2, LT-08300, Vilnius, Lithuania
+370 5 215 1895
Saulius Steponavicius; office@lokmis.lt
Products and Services: Amplifiers, Antennas, Cables & Connectors, Shielded Rooms & Enclosures, Surge & Transients, Test Instrumentation

Comtest - UAB Lokmis

Vilnius, Lithuania
+370 5 215 1895
Saulius Steponavicius; saulius.s@lokmis.lt; www.comtest.eu
Products and services: Anechoic chambers, Reverberation chambers, RF shielded rooms & doors, Microwave absorbers.

EMC Partner

ASTAT sp. zo.o., ul. Dabrowskiego 441, PL-60 451 Poznan, Poland
+48 61 849 80 61; Fax: +48 61 848 82 76;
Lukasz Wilk, l.wilk@astat.com.pl; www.astat.com.pl
Products and Services: Surge & Transients, Test Instrumentation

IFI - Instruments for Industry

AMETEK CTS GmbH, Lünener Str. 211, 59174 Kamen, Germany; +49 2307 26070-0, Fax: +49 2307 17050, sales.cts@ametek.com, www.ametek-cts.com
Products and Services: High Power Microwave and RF Amplifiers (Tetrode Tubes, Solid State and TWT) up to 40 GHz

MILMEGA

AMETEK CTS GmbH, Lünener Str. 211, 59174 Kamen, Germany; +49 2307 26070-0, Fax: +49 2307 17050, sales.cts@ametek.com, www.ametek-cts.com
Products and Services: High Power RF and Microwave solid state amplifiers. Frequency range 80MHz up to 6GHz, with output powers to 1kW

Teseq

AMETEK CTS GmbH, Lünener Str. 211, 59174 Kamen, Germany; +49 2307 26070-0, Fax: +49 2307 17050, sales.cts@ametek.com, www.ametek-cts.com
Products and Services: Amplifiers (RF & Microwave), Antennas,

Automotive Systems, Conducted RF immunity, Conducted Surge & Transients, ESD, Harmonics & Flicker, GTEM cells, RF Immunity Systems, RF Emission Systems, RF Testsoftware, Calibration & Service

Luxembourg

A.H. Systems, Inc.

EEMCCOIMEX, Lelystad, NL
+31 320 295 395; Fax: +31 320 413 133
info@eemc.nl; www.eemccoimex.nl
Products and Services: Antennas, Test Instrumentation, Testing

AR RF/Microwave Instrumentation

Frankrijklaan 7, ITC Boskoop, NL-2391 PX, Hazerswoude-Dorp, the Netherlands
+31(0) 17 242 30 00; Fax: +31(0) 17 242 30 09
Stuart Mulhall, arbeneluxinfo@arworld.us
www.arbenelux.com
Products and Services: Amplifiers, Antennas, Cables & Connectors, Shielded Rooms & Enclosures, Surge & Transients, Test Instrumentation

Comtest Engineering bv

Industrieweg 12
2382 NV Zoeterwoude, The Netherlands
+31-71 5417531; Info@comtest.eu; www.comtest.eu
Products and services: Anechoic chambers, Reverberation chambers, RF shielded rooms & doors, Microwave absorbers.

EM TEST GmbH

Accelonix BV, Postbus 7044, 5605 JA Eindhoven, Netherlands; +31 40 750 1650; Fax: +31 40 293 0722; sales@accelonix.nl; www.accelonix.nl
Products and Services: Innovative test- and measurementsystems für conducted immunity tests, ESD, transients, automotive, harmonics & flicker, AC/DC-sources, safetytest systems, accredited calibrations, seminars, workshops, consulting

Fair-Rite

HF Technology, Atalanta 5, 1562 LC Krommenie Holland
+31(0) 75 628 37 17; Fax: +31(0) 75 621 11 20
info@hftechnology.nl
Products and Services: Antennas, Ferrites

IFI – Instruments for Industry

Accelonix BV, Croy 7, 5653 LC Eindhoven, The Netherlands; +31 40 750 1650; Fax: +31 40 293 0722 sales@accelonix.nl; www.accelonix.nl
Products and Services: High Power Microwave and RF Amplifiers (Tetrode Tubes, Solid State and TWT) up to 40 GHz

MILMEGA

Accelonix BV, Croy 7, 5653 LC Eindhoven, The Netherlands
+31 40 750 1650; Fax: +31 40 293 0722 sales@accelonix.nl; www.accelonix.nl
Products and Services: High Power RF and Microwave solid state amplifiers. Frequency range 80MHz up to 6GHz, with output powers to 1kW

Teseq

Accelonix BV, Croy 7, 5653 LC Eindhoven, The Netherlands
+31 40 750 1650; Fax: +31 40 293 0722 sales@accelonix.nl; www.accelonix.nl
Products and Services: Amplifiers (RF & Microwave), Antennas, Automotive Systems, Conducted RF immunity, Conducted Surge & Transients, ESD, Harmonics & Flicker, GTEM cells, RF Immunity Systems, RF Emission Systems, RF Testsoftware, Calibration & Service

Moldova

AR RF/Microwave Instrumentation

SRL "LOKAMERA"
SRL LOKAMERA, str. Bucuresti 23A, of.415 , Chisinau MD2001 Republic of Moldova
(+373 22) 92 02 33
Nikolai Yasibash; office@lokamera.com.md
Products and Services: Amplifiers, Antennas, Cables & Connectors, Shielded Rooms & Enclosures, Surge & Transients, Test Instrumentation

EM TEST

AMETEK CTS GmbH, Lünener Str. 211, 59174 Kamen, Germany; +49 2307 26070-0, Fax: +49 2307 17050, sales.cts@ametek.com, www.ametek-cts.com
Products and Services: Innovative test- and measurementsystems für conducted immunity tests, ESD, transients, automotive, harmonics & flicker, AC/DC-sources, safetytest systems, accredited calibrations, seminars, workshops, consulting

IFI - Instruments for Industry

AMETEK CTS GmbH, Lünener Str. 211, 59174 Kamen, Germany; +49 2307 26070-0, Fax: +49 2307 17050, sales.cts@ametek.com, www.ametek-cts.com

Products and Services: High Power Microwave and RF Amplifiers (Tetrode Tubes, Solid State and TWT) up to 40 GHz

MILMEGA

InterNET SRL, Calea Grivitei nr. 119, sector 1, 010707 Bucuresti; +40 21 310 7121; Fax: +40 21 312 1663

internet@inter-net.ro; www.inter-net.ro

Products and Services: High Power RF and Microwave solid state amplifiers. Frequency range 80MHz up to 6GHz, with output powers to 1kW

Teseq

InterNET SRL, Calea Grivitei nr. 119, sector 1, 010707 Bucuresti; +40 21 310 7121; Fax: +40 21 312 1663

internet@inter-net.ro; www.inter-net.ro

Products and Services: Amplifiers (RF & Microwave), Antennas, Automotive Systems, Conducted RF immunity, Conducted Surge & Transients, ESD, Harmonics & Flicker, GTEM cells, RF Immunity Systems, RF Emission Systems, RF Testsoftware, Calibration & Service

Norway**AR RF/Microwave Instrumentation**

Compomill Norway

Fløjelbergsgatan 8B, 431 37 Mölndal, Sweden

+46 (0)8-594 111 50; info@compomill.com

Lennarth Engman; le@compomill.com

Products and Services: Amplifiers, Antennas, Cables & Connectors, Shielded Rooms & Enclosures, Surge & Transients, Test Instrumentation

Comtest Engineering bv

Industrieweg 12

2382 NV Zoeterwoude, The Netherlands

+31-71 5417531; Info@comtest.eu; www.comtest.eu

Products and services: Anechoic chambers, Reverberation chambers, RF shielded rooms & doors, Microwave absorbers.

EM TEST

Nortelco Electronics AS, Johan Scharffenbergsvei 95, 0694 Oslo, Norway; +47 2257 6100; Fax: +47 2257 6130; arve.bekkevold@nortelco.no; www.nortelcoelectronics.no

Products and Services: Innovative test- and measurementsystems for conducted immunity tests, ESD, transients, automotive, harmonics & flicker, AC/DC-sources, safetytest systems, accredited calibrations, seminars, workshops, consulting

EMC Partner

ERDE- ELEKTRONIK AB, Spikgatan 8

SE-23532 Vellinge, Sweden

+46 40 42 46 10; Fax: +46 40 42 62 18

Ralf Danielsson; info@erde.se; www.erde.se

Products and Services: Surge & Transients, Test Instrumentation

IFI - Instruments for Industry

AMETEK CTS GmbH, Lünener Str. 211, 59174 Kamen, Germany; +49 2307 26070-0, Fax: +49 2307 17050, sales.cts@ametek.com, www.ametek-cts.com

Products and Services: High Power Microwave and RF Amplifiers (Tetrode Tubes, Solid State and TWT) up to 40 GHz

MILMEGA

AMETEK CTS GmbH, Lünener Str. 211, 59174 Kamen, Germany; +49 2307 26070-0, Fax: +49 2307 17050, sales.cts@ametek.com, www.ametek-cts.com

Products and Services: High Power RF and Microwave solid state amplifiers. Frequency range 80MHz up to 6GHz, with output powers to 1kW

Rohde & Schwarz Norge AG

Østensjøveien 34, 0667 Oslo

+47 (0) 23 38 66 00; Fax: +47 (0) 23 38 66 01

firmapost@rohde-schwarz.com

www.rohde-schwarz.no

Web Store: www.rohde-schwarz.no/surf-in

Products and Services: EMC Test Equipment and Accessories, Broadband Amplifiers, EMC Test Software, Turnkey Test System Solutions

Schlegel Electronic Materials

Nortelco AS, Johan Scharffenbergsvei 95, N-0694 Oslo,

+47 22 57 61 00; +47 90 64 43 84; Fax: +47 22 57 61 30

Live Odgaard, live@nortelco.no

www.nortelcoelectronics.no

Products and services: Conductive materials, shielding

Tech-Etch, Inc.

EG Components Norway AS,

Hovfaret 17 B, N0275 Oslo Norway

+47 2325 4600; Fax: +47 2325 4601

info@egcomponents.no; www.techetch.com

Products and Services: Conductive Materials, Shielding

Teseq

AMETEK CTS GmbH, Lünener Str. 211, 59174 Kamen, Germany; +49 2307 26070-0, Fax: +49 2307 17050, sales.cts@ametek.com, www.ametek-cts.com

Products and Services: Amplifiers (RF & Microwave), Antennas, Automotive Systems, Conducted RF immunity, Conducted Surge & Transients, ESD, Harmonics & Flicker, GTEM cells, RF Immunity Systems, RF Emission Systems, RF Testsoftware, Calibration & Service

Portugal**AR RF/Microwave Instrumentation**

Spantech Microwave Technology S.A.

Nave 6, Polígono La Moraga

29130 Alhaurin de la Torre, Málaga, Spain

+34-95-241-7024; Desirée Them; sales@spantech.es

Products and Services: Amplifiers, Antennas, Cables & Connectors, Shielded Rooms & Enclosures, Surge & Transients, Test Instrumentation

Comtest - Alava Ingenieros

Madrid, Spain.

+34 915679720/26

Maxi Herrera; mherrera@alava-ing.es; www.comtest.eu

Products and services: Anechoic chambers, Reverberation chambers, RF shielded rooms & doors, Microwave absorbers.

EM TEST

ALAVA Ingenieros S.A., C/ Albasanz 16 - Edificio Antalia, 28037 Madrid; +34 91 567 97 00 Fax: +34 91 570 26 61; joseantonio.fernandez@ametek.com; www.emtest.com

Products and Services: Innovative test- and measurementsystems for conducted immunity tests, ESD, transients, automotive, harmonics & flicker, AC/DC-sources, safetytest systems, accredited calibrations, seminars, workshops, consulting

EMC Partner

WAVECONTROL, Pallars, 65-71,

ES-08018 Barcelona, Spain

+34 933 208 055; Fax: +34 933 208 056

Jordi Accensi, jordi-accensi@wavecontrol.com

www.wavecontrol.com

Products and Services: Surge & Transients, Test Instrumentation

IFI - Instruments for Industry

VITELISIS - Soc. Com. De Electrotecnica, Lda., Rua Alvaro Ferreira Alves, 15 C, 2855-591 Corroios

+351 21 258 3619; Fax: +351 21 258 8087

geral@vitelisis.pt; www.vitelisis.pt

Products and Services: High Power Microwave and RF Amplifiers (Tetrode Tubes, Solid State and TWT) up to 40 GHz

MILMEGA

VITELISIS - Soc. Com. De Electrotecnica, Lda., Rua Alvaro Ferreira Alves, 15 C, 2855-591 Corroios

+351 21 258 3619; Fax: +351 21 258 8087

geral@vitelisis.pt; www.vitelisis.pt

Products and Services: High Power RF and Microwave solid state amplifiers. Frequency range 80MHz up to 6GHz, with output powers to 1kW

Teseq

VITELISIS - Soc. Com. De Electrotecnica, Lda., Rua Alvaro Ferreira Alves, 15 C, 2855-591 Corroios;

+351 21 258 3619; Fax: +351 21 258 8087;

geral@vitelisis.pt; www.vitelisis.pt

Products and Services: Amplifiers (RF & Microwave), Antennas, Automotive Systems, Conducted RF immunity, Conducted Surge & Transients, ESD, Harmonics & Flicker, GTEM cells, RF Immunity Systems, RF Emission Systems, RF Testsoftware, Calibration & Service

Romania**A.H. Systems, Inc.**

CELESTA COMEXIM SRL, Bucharest

+40 21 410 30 64; Fax: +4021 410 31 17

celesta@celesta.ro; www.celesta.ro/en

Products and Services: Antennas, Test Instrumentation, Testing

AR RF/Microwave Instrumentation

COMTEST SRL, Olari 7A, 024056 Bucharest, Romania

+4021 211 08 83; Fax: +4021 211 08 84

Radu Mateescu, radum@comtest.ro; www.comtest.ro

Products and Services: Amplifiers, Antennas, Cables & Connectors, Shielded Rooms & Enclosures, Surge & Transients, Test Instrumentation

Comtest Communications Test Systems

Bucarest, Romania

+40 212 110883

Radu Mateescu; radum@comtest.ro; www.comtest.eu

Products and services: Anechoic chambers, Reverberation chambers, RF shielded rooms & doors, Microwave absorbers.

EM TEST GmbH

AMETEK CTS GmbH, Lünener Str. 211, 59174 Kamen, Germany; +49 2307 26070-0, Fax: +49 2307 17050, sales.cts@ametek.com, www.ametek-cts.com

Products and Services: Innovative test- and measurementsystems for conducted immunity tests, ESD, transients, automotive, harmonics & flicker, AC/DC-sources, safetytest systems, accredited calibrations, seminars, workshops, consulting

IFI - Instruments for Industry

AMETEK CTS GmbH, Lünener Str. 211, 59174 Kamen, Germany; +49 2307 26070-0, Fax: +49 2307 17050, sales.cts@ametek.com, www.ametek-cts.com

Products and Services: High Power Microwave and RF Amplifiers (Tetrode Tubes, Solid State and TWT) up to 40 GHz

MILMEGA

InterNET SRL, Calea Grivitei nr. 119

sector 1, 010707 Bucuresti

+40 21 310 7121; Fax: +40 21 312 1663

internet@inter-net.ro; www.inter-net.ro

Products and Services: High Power RF and Microwave solid state amplifiers. Frequency range 80MHz up to 6GHz, with output powers to 1kW

Rohde & Schwarz Romania SRL

89 Eroii Sanitari Blvd.; sector 5

050472 Bukarest, Romania

+40 21 4112013; Fax: +40 21 4106846

www.rohde-schwarz.com

http://shop.rohde-schwarz.com/cee

Products and Services: EMV Test Equipment and Accessories; Broadband Amplifiers; EMC Test Software; Turnkey Test System Solutions

SCHURTER

SC INTERELEKTRONICS R.L, Comuna Gruui, sat Santu - Floresti,

Str. Ungureni, Nr. 103, 077118 Judet Ilfov

+402 135 08 100; contact@ticomel.ch; www.ticomel.ch

Products and Services: Filters, Shielding

Teseq

InterNET SRL, Calea Grivitei nr. 119, sector 1, 010707 Bucuresti;

+40 21 310 7121; Fax: +40 21 312 1663

internet@inter-net.ro; www.inter-net.ro

Products and Services: Amplifiers (RF & Microwave), Antennas, Automotive Systems, Conducted RF immunity, Conducted Surge & Transients, ESD, Harmonics & Flicker, GTEM cells, RF Immunity Systems, RF Emission Systems, RF Testsoftware, Calibration & Service

Würth Elektronik Romania

Str. Gospodarilor Nr. 13/1

RO-400140 Cluj-Napoca

+40 744 77 35 30; eiSos-romania@we-online.com

Products and Services: Cables & Connectors, Ferrites

Russia**A.H. Systems, Inc.**

Sernia, Moscow;

+7 495 225 40 42; Fax: +7 495 932 92 44

office@sernia.ru; www.sernia-msk.ru

Products and Services: Antennas, Test Instrumentation, Testing

AR RF/Microwave Instrumentation

Radiant-Elcom, 117246, Nautchny proezd, 8 b.1, Moscow;

+7495 725 0404; Fax: +7495 921 3585;

Sergey Pavlov, ps@ranet.ru; www.radiant.su

Products and Services: Amplifiers, Antennas, Cables & Connectors, Shielded Rooms & Enclosures, Surge & Transients, Test Instrumentation

Comtest - EMCI

Moscow, Russia

+7 495 410-6465

Mikhael Kuznetsov; info@EMCI.ru; www.comtest.eu

Products and services: Anechoic chambers, Reverberation chambers, RF shielded rooms & doors, Microwave absorbers.

EM TEST

EMCI, 105005, Radio Str., 24, Building 1 (office), Moskau, Russland; +7 (495) 410 64 65; Fax: +7 (495) 980 71 19; info@emci.ru; www.emci.ru
Products and Services: Innovative test- and measurementsystems für conducted immunity tests, ESD, transients, automotive, harmonics & flicker, AC/DC-sources, safetytest systems, accredited calibrations, seminars, workshops, consulting

EMC Partner

AMIDEON Systems Ltd. Innovation works, National Technology Park, IE- Limerick, Ireland; +353 61 503 007; Fax: +353 61 338 065; Barry Lunn, sales@amideon.com; www.amideon.com
Products and Services: Surge & Transients, Test Instrumentation

IFI – Instruments for Industry

ZAO NFP Dipaul Ltd., 2½3a Professora Popova Street, 197376 St. Petersburg; +7 812 325 1478; Fax: 7 812 325 1478; shuval@dipaul.ru; www.dipaul.ru
Products and Services: High Power Microwave and RF Amplifiers (Tetrode Tubes, Solid State and TWT) up to 40 GHz

MILMEGA

EMCI, Radio str 24, Building 1, 105005 Moscow; Tel +7 495 410 6465; Fax +7 495 791 7107; info@emci.ru; www.emci.ru
Products and Services: High Power RF and Microwave solid state amplifiers. Frequency range 80MHz up to 6GHz, with output powers to 1kW

Rohde & Schwarz Rus 000

Pavlovskaya str. 7., 115093 Moscow +7 (0) 495 981 35 60; Fax +7 (0) 495 981 35 65 info.russia@rohde-schwarz.com www.rohde-schwarz.ru
Products and Services: EMC Test Equipment and Accessories, Broadband Amplifiers, EMC Test Software, Turnkey Test System Solutions

TDK RF Solutions Inc.

Avangard - Kondrat'evskiy prospekt, 72, Saint-Petersburg, 195271 Russia; k.andreyev@avangard.io; www.tdkrfsolutions.com
Products and Services: Antennas, Filters, Software, Testing services

Teseq

ZAO NFP Dipaul Ltd., 2½3a Professora Popova Street, 197376 St. Petersburg; +7 812 325 1478; Fax: 7 812 325 1478; shuval@dipaul.ru; www.dipaul.ru
Products and Services: Amplifiers (RF & Microwave), Antennas, Automotive Systems, Conducted RF immunity, Conducted Surge & Transients, ESD, Harmonics & Flicker, GTEM cells, RF Immunity Systems, RF Emission Systems, RF Testsoftware, Calibration & Service

Würth Elektronik Russia

+7 916 543 50 30; eiSos-russia@we-online.com
Products and Services: Cables & Connectors, Ferrites

Serbia

AR RF/Microwave Instrumentation

AR Europe - First Floor Ashling Building, National Technology Park, Limerick, Ireland +33 628 055 666; Jérôme Surowiec;jsurowiec@arworld.us
Products and Services: Amplifiers, Antennas, Cables & Connectors, Shielded Rooms & Enclosures, Surge & Transients, Test Instrumentation

Comtest Engineering bv

Industrieweg 12 2382 NV Zoeterwoude; The Netherlands +31-71 5417531; Info@comtest.eu; www.comtest.eu
Products and services: Anechoic chambers, Reverberation chambers, RF shielded rooms & doors, Microwave absorbers

EM TEST GmbH

EM TEST GmbH, Lünener Strasse 211, 59174 Kamen, Germany; +49 2307 / 26070-0; Fax: +49 (0)2307 / 170 50; sales-international.emtest@ametek.de; www.emtest.de
Products and Services: Innovative test- and measurementsystems für conducted immunity tests, ESD, transients, automotive, harmonics & flicker, AC/DC-sources, safetytest systems, accredited calibrations, seminars, workshops, consulting

IFI – Instruments for Industry

Tectra AG Predstavništvo Beograd, Begejska 2a, 11000 Beograd; +381 11 2894 424; Fax +381 11 3049 640; office@tectra.co.rs; www.tectra.co.rs
Products and Services: High Power Microwave and RF Amplifiers (Tetrode Tubes, Solid State and TWT) up to 40 GHz

MILMEGA

Tectra AG Predstavništvo Beograd, Begejska 2a, 11000 Beograd; +381 11 2894 424; Fax +381 11 3049 640; office@tectra.co.rs; www.tectra.co.rs
Products and Services: High Power RF and Microwave solid state amplifiers. Frequency range 80MHz up to 6GHz, with output powers to 1kW

Rohde & Schwarz Österreich Ges.m.b.H.

Representative Office Belgrade, Spanskih boraca 3 11070 Belgrad, Serbia +381 11 65568 14; Fax: +381 11 3122 834 www.rohde-schwarz.com
Products and Services: EMV Test Equipment and Accessories; Broadband Amplifiers; EMC Test Software; Turnkey Test System Solutions

Teseq

Tectra AG Predstavništvo Beograd, Begejska 2a, 11000 Beograd; +381 11 2894 424; Fax +381 11 3049 640; office@tectra.co.rs; www.tectra.co.rs
Products and Services: Amplifiers (RF & Microwave), Antennas, Automotive Systems, Conducted RF immunity, Conducted Surge & Transients, ESD, Harmonics & Flicker, GTEM cells, RF Immunity Systems, RF Emission Systems, RF Testsoftware, Calibration & Service

Slovakia

AR RF/Microwave Instrumentation

H TEST Slovakia spol. s r.o. Zvolenská cesta 20, 97405 Banská Bystrica +421 484 324 350; Jozef Ambrozai; info@hstest.sk
Products and Services: Amplifiers, Antennas, Cables & Connectors, Shielded Rooms & Enclosures, Surge & Transients, Test Instrumentation

Comtest - H TEST Slovakia, spol. s r.o

97405 Banská Bystrica, SLOVAK REPUBLIC +421 917765 249; Jozef Ambrozai; ambrozai@hstest.sk; www.comtest.eu
Products and services: Anechoic chambers, Reverberation chambers, RF shielded rooms & doors, Microwave absorbers.

EM TEST

Testovací Technika s.r.o., Hakenova 1423, 290 01 Pobebrady, Tschechische Republik; +42 325 610 123; Fax: +42 325 610 134; teste@teste.cz; www.teste.cz
Products and Services: Innovative test- and measurementsystems für conducted immunity tests, ESD, transients, automotive, harmonics & flicker, AC/DC-sources, safetytest systems, accredited calibrations, seminars, workshops, consulting

EMC Partner

TECTRA A.S., Domkova 234343, CZ-193 00 Praha, Czech Republic +420 281 921 650; Fax: +420 281 921 649; Herr Ing. Zbynek Sommer; tectra@tectra.cz; www.tectra.cz
Products and Services: Surge & Transients, Test Instrumentation

IFI – Instruments for Industry

Empos Spol s.r.o., U Novych Vil 18, 10000 Praha 10, Czech Republic; +420 2 4174 2084; Fax +420 4174 2088; info@empos.cz; www.empos.cz
Products and Services: High Power Microwave and RF Amplifiers (Tetrode Tubes, Solid State and TWT) up to 40 GHz

MILMEGA

Empos Spol s.r.o., U Novych Vil 18, 10000 Praha 10, Czech Republic; +420 2 4174 2084; Fax +420 4174 2088; info@empos.cz; www.empos.cz
Products and Services: High Power RF and Microwave solid state amplifiers. Frequency range 80MHz up to 6GHz, with output powers to 1kW

SCHURTER (SK) s.r.o

Piestanska 404, 95605 Radosina +42 138 539 84 80; www.schurter.com
Products and Services: Filters, Shielding

Teseq

Empos Spol s.r.o., U Novych Vil 18, 10000 Praha 10, Czech Republic +420 2 4174 2084; Fax +420 4174 2088 info@empos.cz; www.empos.cz
Products and Services: Amplifiers, Antennas, Automotive Systems, Conducted RF immunity, Conducted Surge & Transients, ESD, Harmonics & Flicker, GTEM cells, RF Immunity Systems, RF Emission Systems, RF Testsoftware, Calibration & Service

Würth Elektronik Slovakia

Prehradn 363, CZ-76316 Frystak, Slovakia +420-577-104-607 eiSos-slovakia@we-online.com
Products and Services: Cables & Connectors, Ferrites

Slovenia

AR RF/Microwave Instrumentation

AR Europe First Floor Ashling Building, National Technology Park Limerick, Ireland +33 628 055 666; Jérôme Surowiec;jsurowiec@arworld.us
Products and Services: Amplifiers, Antennas, Cables & Connectors, Shielded Rooms & Enclosures, Surge & Transients, Test Instrumentation

Comtest Engineering bv

Industrieweg 12, 2382 NV Zoeterwoude, The Netherlands +31-71 5417531; Info@comtest.eu; www.comtest.eu
Products and services: Anechoic chambers, Reverberation chambers, RF shielded rooms & doors, Microwave absorbers

EM TEST GmbH

AMETEK CTS GmbH, Lünener Str. 211, 59174 Kamen, Germany; +49 2307 26070-0; Fax: +49 2307 17050, sales-international.cts@ametek.com; www.ametek-cts.com
Products and Services: Innovative test- and measurementsystems für conducted immunity tests, ESD, transients, automotive, harmonics & flicker, AC/DC-sources, safetytest systems, accredited calibrations, seminars, workshops, consulting

IFI – Instruments for Industry

Tectra d.o.o., Stegne 21, 1000 Ljubljana; +386 1 511 46 12; Fax +386 1 511 46 13 tectra@tectra.si
Products and Services: High Power Microwave and RF Amplifiers (Tetrode Tubes, Solid State and TWT) up to 40 GHz

MILMEGA

Tectra d.o.o., Stegne 21, 1000 Ljubljana; +386 1 511 46 12; Fax +386 1 511 46 13 tectra@tectra.si
Products and Services: High Power RF and Microwave solid state amplifiers. Frequency range 80MHz up to 6GHz, with output powers to 1kW

Rohde & Schwarz Österreich Ges.m.b.H.

Representative Office Ljubljana Tbilisjska 89, 1000 Ljubljana, Slovenia +386 1 4234651; Fax: +386 1 4234611 www.rohde-schwarz.com http://shop.rohde-schwarz.com/cee
Products and Services: EMV Test Equipment and Accessories; Broadband Amplifiers; EMC Test Software; Turnkey Test System Solutions

Teseq

Tectra d.o.o., Stegne 21, 1000 Ljubljana; +386 1 511 46 12; Fax +386 1 511 46 13; tectra@tectra.si
Products and Services: Amplifiers (RF & Microwave), Antennas, Automotive Systems, Conducted RF immunity, Conducted Surge & Transients, ESD, Harmonics & Flicker, GTEM cells, RF Immunity Systems, RF Emission Systems, RF Testsoftware, Calibration & Service

Würth Elektronik Slovenia

Dom in vrt 27, SL-1420 Trbovlje, Slovenia Tel. +386 30 60 3644; eiSos-slovenia@we-online.com
Products and Services: Cables & Connectors, Ferrite

Sweden

A.H. Systems, Inc.

MITT Design and Verification AB +46 844 677 30; Fax: +46 844 677 45 sales@mttab.se; http://agetomt.com
Products and Services: Antennas, Test Instrumentation, Testing

AR RF/Microwave Instrumentation

Compomill Sweden Box 4 (Dragonvagen 42), 194 21 UPPLANDS VASBY +46 (0)8-594 111 50; Fax: +46 (0)8-594 211 60 info@compomill.com
Products and Services: Amplifiers, Antennas, Cables & Connectors, Shielded Rooms & Enclosures, Surge & Transients, Test Instrumentation

Comtest - CE-BIT Elektronik AB

TÅBY, Sweden +46-87357550 Ingemar Islander; Ingemar@cebit.se

www.comtest.eu

Products and Services: Anechoic chambers, Reverberation chambers, RF shielded rooms & doors, Microwave absorbers

EM TEST

PROXITRON AB, Box 324, 591 24 Motala, Sweden; +46 141-580 00; Fax: +46 141-584 95; info@proxitron.se; www.proxitron.se
Products and Services: Innovative test- and measurementsystems für conducted immunity tests, ESD, transients, automotive, harmonics & flicker, AC/DC-sources, safetytest systems, accredited calibrations, seminars, workshops, consulting

EMC Partner

ERDE- ELEKTRONIK AB, Spikgatan 8, SE-23532 Vellinge, Sweden; +46 40 42 46 10; Fax: +46 40 42 62 18; Ralf Danielsson; info@erde.se; www.erde.se
Products and Services: Surge & Transients, Test Instrumentation

IFI - Instruments for Industry

AGETO MTT AB, Propellervägen 6B, 183 62 Täby +46 8 446 77 30; Fax +46 8 446 77 45 sales@agetomtt.com; www.agetomtt.se
Products and Services: High Power Microwave and RF Amplifiers (Tetrode Tubes, Solid State and TWT) up to 40 GHz

Fair-Rite

Ce-Bit Elektronik, Box 7055, 18711 Täby; +46 8 735 7550; Fax: +46 8 735 6165; info@cebit.se

Schaffner EMC AB; Turebergstorg 1,

6 S-10147 Sollentuna; +46 8 5792 1121; Fax: +46 8 929 690; swedensales@schaffner.com
Products and Services: Antennas, Ferrites

Langer EMV-Technik GmbH

Ingenjörfirman, Ekeby Gard, Ekebyborna 250, SE-59195 Motala; +46 8 930 280; +46 14 171 151; hans.petterson@igpab.se; www.igpab.se
Products and Services: Test Instrumentation

MILMEGA

AGETO MTT AB, Propellervägen 6B, 183 62 Täby; +46 8 446 77 30; Fax +46 8 446 77 45; sales@agetomtt.com; www.agetomtt.se
Products and Services: High Power RF and Microwave solid state amplifiers. Frequency range 80MHz up to 6GHz, with output powers to 1kW

Rohde & Schwarz Sverige AB

Flygfältsgatan 15, 128 30 Skarpnäck +46 (0) 8 605 19 00; Fax +46 (0) 8 605 19 80 info.sweden@rohde-schwarz.com www.rohde-schwarz.se; Web Store: www.rohde-schwarz.se/surf-in
Products and Services: EMC Test Equipment and Accessories, Broadband Amplifiers, EMC Test Software, Turnkey Test System Solutions

SCHURTER Nordic AB

Sandsborgsvägen 50, 122 33 Enskede; +46 8 447 35 60; info@schurter.se; www.schurter.se
Products and Services: Filters, Shielding

Schlegel Electronic Materials

EG Electronics Grimstagatan 160, SE-162 11 Vällingby, Sweden +46 8 759 35 23; Fax: +46 70 524-52 66 Stefan Ellerstad, stefan.ellerstad@egelectronics.com www.egelectronics.com
Products and Services: Conductive materials, shielding

TDK Electronics Nordic

Box 46, Torshamnsgatan S-164 93 Kista Sweden +46 8 590 99 100; info@tdkrf.com www.tdkrfsolutions.com
Products and Services: Antennas, software, testing

Teseq

AGETO MTT AB, Propellervägen 6B, 183 62 Täby; +46 8 446 77 30; Fax +46 8 446 77 45 sales@agetomtt.com; www.agetomtt.se
Products and Services: Amplifiers (RF & Microwave), Antennas, Automotive Systems, Conducted RF immunity, Conducted Surge & Transients, ESD, Harmonics & Flicker, GTEM cells, RF Immunity Systems, RF Emission Systems, RF Testsoftware, Calibration & Service

Ukraine

AR RF/Microwave Instrumentation

Radiant-Elcom, 117246, Nautchny proezd, 8 b.1, Moscow +7495 725 0404; Fax: +7495 921 3585 Sergey Pavlov, ps@ranet.ru; www.radiant.su
Products and Services: Amplifiers, Antennas, Cables & Connectors, Shielded Rooms & Enclosures, Surge & Transients, Test Instrumentation

EM TEST

AMETEK CTS GmbH, Lünener Str.211, 59174 Kamen, Germany; +49 2307 26070-0, Fax: +49 2307 17050, sales-international.cts@ametec.com; www.ametek-cts.com
Products and Services: Innovative test- and measurementsystems für conducted immunity tests, ESD, transients, automotive, harmonics & flicker, AC/DC-sources, safetytest systems, accredited calibrations, seminars, workshops, consulting

IFI - Instruments for Industry

UNITEST Ltd., 6 Olesya honchara St., 01034, Kyiv +380 44 272 6094; Fax +380 44 272 6095 victor_butyryn@unistest.com; www.unitest.com
Products and Services: High Power Microwave and RF Amplifiers (Tetrode Tubes, Solid State and TWT) up to 40 GHz

MILMEGA

UNITEST Ltd., 6 Olesya honchara St., 01034, Kyiv +380 44 272 6094; Fax +380 44 272 6095; victor_butyryn@unistest.com; www.unitest.com
Products and Services: High Power RF and Microwave solid state amplifiers. Frequency range 80MHz up to 6GHz, with output powers to 1kW

Rohde & Schwarz Österreich Ges.m.b.H.

Representative Office Kiev 9/2,Chervonoarmiyska Str. office 68 01004 Kiev, Ukraine +38 044 2896055; Fax: +38 044 289 8364 http://www.rohde-schwarz.com.ua/
Products and Services: EMV Test Equipment and Accessories; Broadband Amplifiers; EMC Test Software; Turnkey Test System Solutions

Teseq

UNITEST Ltd., 6 Olesya honchara St., 01034, Kyiv +380 44 272 6094; Fax +380 44 272 6095; victor_butyryn@unistest.com; www.unitest.com
Products and Services: Amplifiers (RF & Microwave), Antennas, Automotive Systems, Conducted RF immunity, Conducted Surge & Transients, ESD, Harmonics & Flicker, GTEM cells, RF Immunity Systems, RF Emission Systems, RF Testsoftware, Calibration & Service

ADVERTISER INDEX

Aaronia AG	Back Cover, 27, 49, 75	IEEE 2015 EMC Symposium	17
A.H. Systems, Inc.	25, 52, 72, 87, 96, 103, 113, 136	IFI, a TESEQ company	77, 98
Albatross Projects GmbH	59	Interference Technology	99
AR RF/Microwave Instrumentation	21, 47, 71, 85,	Kemtron Limited	28
.....	93, 101, 111, 121, 125	Montrose Compliance Services	29
ASTAT Sp. z o.o.	105	Microwave & RF Show Paris	18
EMC Live	Inside Back Cover, 74	MILMEGA, a TESEQ Company	33, 115
EM TEST AG	51, 107	Narda Safety Test Solutions	31, 58, 73
Empower RF Systems, Inc.	5	Rohde & Schwarz	45, 95
EMV 2015	13	Schlegel Electronic Materials	55
ESD Association	15	TDK RF Solutions	19, 57
ETS Lindgren	37	TESEQ	Inside Front Cover, 61, 88, 104, 123, 127, 137
European Microwave Week	89	Wavecontrol	97
Fair-Rite Products Corp.	54	Würth Elektronik eiSos	50

EMC Practice – Measurement Under Interference

CLEAN TRANSMISSION OF SIGNALS FROM THE EUT

JÖRG HACKER

Engineer

Langer EMV-Technik GmbH

IT IS UNCOMMON to use an oscilloscope to monitor signals from the EUT when testing immunity to interference. The complicated environmental conditions in the anechoic chamber during RF irradiation or burst and ESD tests lead to measuring errors and unwanted interference in the EUT. Modifications to the EUT are accordingly done by “trial and error”.

These difficulties can be overcome by careful measurement using small and interference-immune measuring systems. Causes for malfunction are quicker to find this way.

1 AIM OF THE MEASUREMENTS:

1.1 Detect Interference

Interference is traditionally detected by observing the EUT. The subjective nature of this observation introduces inaccuracies. Automatic testing procedures are not possible. Electronic display monitoring or measurement of output signals from the EUT can help in this situation.

1.2 Trace Back Disturbed Signals

EMC practice is often complex. Interferences in EUT can occur simultaneously at different places via different modes of action. To eliminate errors effectively, it is crucial to analyse disturbed signals from the EUT. This concerns the disturbance of signals in both digital and analogue systems.

These measurements allow conclusions to be drawn as to the cause of error as well as an evaluation of the effectiveness of EMC measures directly at the site of interference.

2 REQUIREMENTS FOR MEASURING EQUIPMENT:

2.1 General Requirements

Injecting disturbances, e.g. using a line impedance stabilization network on the burst test station, produces physical quantities in the EUT such as current, voltage, magnetic field and electric field. Their spatial distribution, intensity and orientation are determined by the geometric structure of the metallic system of the EUT and measuring station. They are almost impossible to predict given the complexity of the EUT.

These quantities also act on the measuring equipment, such as the probe tip and measuring lines, but must not be allowed to cause false readings. What field strengths must the measuring equipment be able to withstand?

In the case of ESD, the entire disturbance voltage can exist between the metallic housing and the PCB insulated against it. At a distance of 5 mm, 5 kV ESD creates a field strength of 1 kV/mm, i.e. 1 MV/m! The disturbance current flowing through the EUT produces

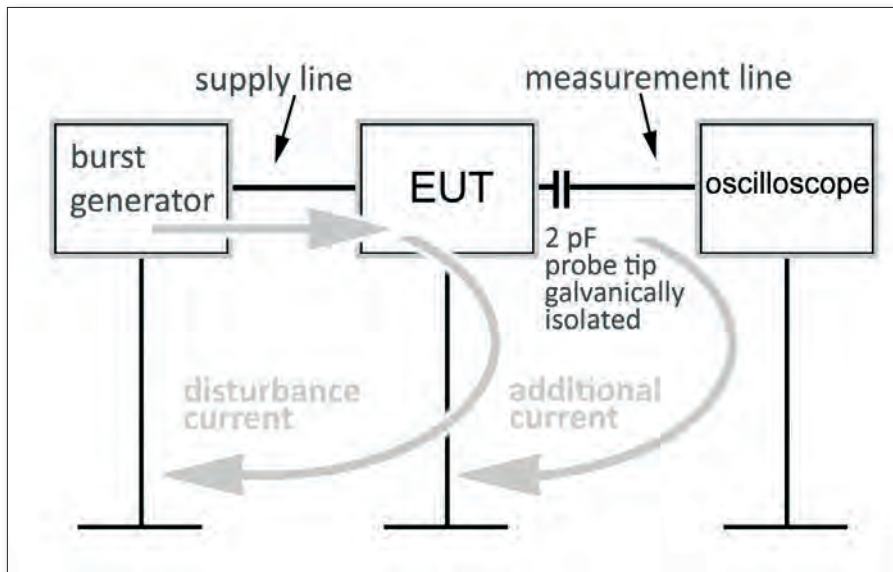

FIGURE 1: Disturbance current flows through a galvanically isolated probe tip.

magnetic fields in the range of several milliteslas.

The field strengths are much lower for RF irradiation, and reach up to about 200 V/m, depending on the test requirements.

To achieve error-free measurements under these conditions, the EUT and measuring equipment must be galvanically isolated. Only then will the path of the disturbance current in the EUT not be impermissibly modified. It must be noted here that an optocoupler, for example, used for galvanic isolation possess a parasitic capacity of a few pF between the primary and secondary side. It depends on the EUT construction as to how much this capacity will transmit impermissible disturbance current (Figure 1). Optimally, the measurement should be done using fibre optics, since then hardly any parasitic capacity exists at all. It also rules out any change in the disturbance fields by additional cables. It does, however, require a probe tip that converts the signal to be measured into a light signal and which is itself so small that it does not impermissibly deform the disturbance fields.

2.2 Measuring Analogue Signals

2.2.1 Mechanism of Interference

Especially critical for analogue systems are RF irradiation via the antenna and RF coupling in the lines. Most analogue systems are resistant to burst/ESD errors, since their bandwidth is not high enough to detect these short disturbance pulses.

High-frequency electric and magnetic fields are coupled into the EUT from the electromagnetic field through the EUT surface or via connected leads. These fields produce disturbance voltages on signal lines

and in the GND system. Modulation of the RF disturbance field is especially problematic. The standard demands the carrier frequency be modulated to 80% AM at 1 kHz. The RF can be demodulated at pn junctions, e.g. in operational amplifiers. As a consequence, a voltage with a frequency of 1 kHz arises, which superimposes itself over the useful signal and is carried over into the analogue signal path.

2.2.2 Requirements For The Measuring System Bandwidth

For troubleshooting, it is usually sufficient to measure the demodulated 1 kHz signal in the EUT. The RF carrier itself need not be measured. This means a small and low-cost measuring system can be used.

With the help of a small probe tip with an A/D-converter, the 1 kHz error signal is converted into digital light signals and transmitted from the EUT over fibre optic cable without feedback (Figure 2).

The measuring signal in the EUT is generally superimposed with RF voltages. Upon measurement, these voltages are applied to the probe tip, i.e. the probe tip must be immune to interference at field strengths of up to 200 V/m.

MEASUREMENT RANGE:

Practically required measurement ranges are between 5 mV (audio equipment and sensors) and 50 V (automation equipment, ASI bus, vehicle on-board wiring system). A high dynamic range is preferable. Limits are set by the small size, the transmission capacity of serial transmission and the power draw of the probe tip..

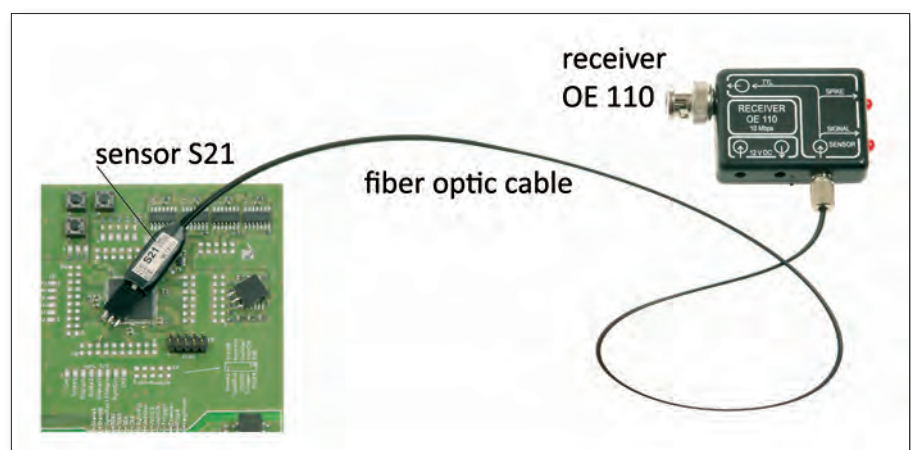

FIGURE 2: System for transmitting signals over fibre optics.

2.3 Measuring digital signals

2.3.1 Mechanism of interference

Short disturbance pulses such as burst and ESD are especially critical for digital circuits. Every IC input evaluates the disturbance voltage pulse at its input with its dynamic input switching threshold. When its switching threshold is exceeded, this pulse is converted to a logical signal and fed into the program sequence. This then triggers very specific functional errors, depending on the EUT.

The interference immunity of the EUT is essentially determined by the sensitivity of the IC. The definition of a sensitivity parameter is a crucial for coping with the interference processes. It depends on the IC technology (HC, AC, VHC, etc.), on the shrink and therefore on the IC manufacturer. The scatter range of IC sensitivity for all modern IC families lies at a factor of 10. The resulting deviation of burst immunity can lie within the kV range.

2.3.2 Requirements for the measuring system

It is difficult to produce a probe tip at reasonable cost that, on the one hand, is small enough not to interfere with the EUT and, on the other hand, transmits the rapid disturbance voltage pulses over fibre optic cable error-free at the given field strengths. It is, however, possible to introduce a special probe tip (which we will refer to from here on as a sensor) into the EUT. This sensor possesses a digital IC of known sensitivity. When this IC recognizes, with its dynamic input threshold, a voltage pulse (or disturbance voltage pulse), it emits a defined light pulse. In this way, it reproduces the interference threshold of the electronic device. A light pulse thus signifies: "A disturbance pulse has occurred in the EUT on the tested circuit that is large enough to disturb the device's function."

2.4 Potential measurement

By transmitting signals over fibre optic cable, these systems are also in principle suitable for potential measurement. The only thing to ensure is the power supply of the probe tip is

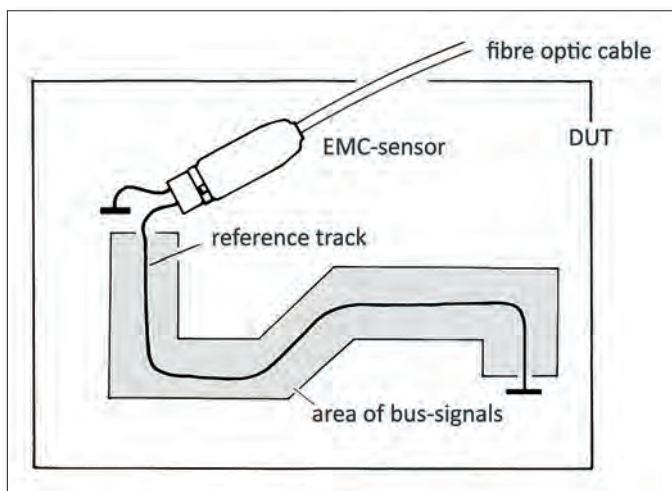

FIGURE 3: Measuring voltage differences over the GND system

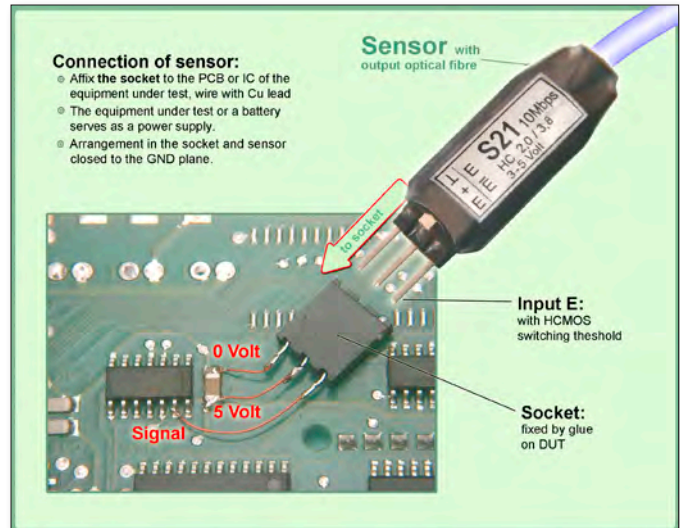

FIGURE 2a: How to connect the sensor in the DUT.

made potential-free, e.g. using a battery module.

This is useful for measuring, for example, transients in the intermediate circuit voltage of pulse inverters.

3 MEASURING STRATEGIES

3.1 Measuring disturbances

A reference interference threshold is created using a sensor and a conductive trace on the Device Under Test (Figure 3).

With the conductive trace, the sensor taps voltage differences over the GND system of the EUT that are caused by disturbance current in the GND system (Figure 3). When the sensor's interference threshold is exceeded, it emits a light signal over a fibre optic cable. This is a quick way to evaluate the effectiveness of countermeasures.

This method is mainly employed for dimensioning connector systems, shields, filters and current leakage paths. It can also be employed during the developmental phase, when the EUT itself is not yet functional but information is already needed on the design of housing and filters.

3.2 Measuring static signals

When troubleshooting, it is useful to monitor certain signals in order to learn the instantaneous state of the EUT. Of interest are signals such as INT, RESET or PFI, which are also transmitted by a sensor from the EUT over a fibre optic cable. A counter (event counter) can summate the light pulses and thereby serve as a memory. That means continuous, concentrated monitoring of a display is no longer necessary – modifications can be made freely while the measurement is still running.

The origin of the interference can often be learnt by monitoring the signals on an oscilloscope (via fibre optics): In Figure 5, a short disturbance pulse on the RESET line of a processor signifies direct interference on this line, while a pulse in the millisecond range is caused by interference on the RESET component.

3.3 Measuring periodic signals

3.3.1 Monitoring the EUT

Often, it cannot be determined whether the EUT is still running during interference immunity tests. For example, the controller may have long since crashed while the LCD display still shows the correct data. The transmission of characteristic signals from the EUT is helpful in such cases. A signal such as Chip Select, for example, shows that the processor is still working.

3.3.2 Signal monitoring

If the disturbances are coupled into the bus system, for example, then it is possible to detect disturbance pulses on the oscilloscope. Measurements are done with sensors via fibre optics, with triggering over the pulse width of the measured signal. The pulse width of the useful signal is typically larger than that of the disturbance pulses. If the oscilloscope does not have such a triggering option, or if the data and interference signal are almost equally long, then one can trigger the disturbances manually using a burst detector.

3.4 Analysing operating behaviour

Frequently, the data on bus systems give an indication of the operating state of the EUT. Precisely analysing the data on an oscilloscope or logic analyser is laborious in such cases. One quick option is to monitor the data stream with a counter. Naturally, given the changing data content and lack of synchronization between counter and data packets, one does not always obtain a constant numeric value on the counter. Mostly, however, specific operating states are assigned specific numeric values. The developer can therefore recognize, for example, specific pulse sequences during system start-up after RESET and infer the current operating state of the EUT. When testing immunity using this simple analytical system, it can be discerned whether, for example, the system is restarting

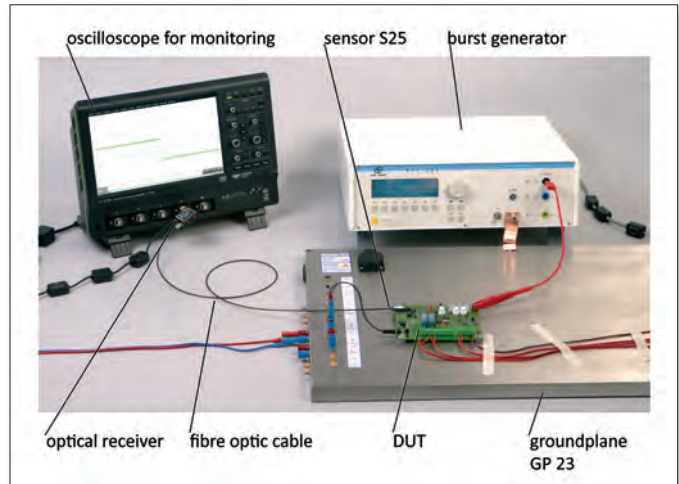

FIGURE 4: Signal measurement over fibre optic cable.

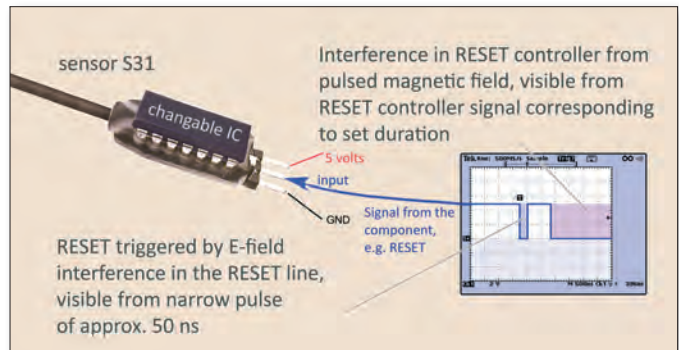

FIGURE 5: RESET monitoring using a sensor S31: The sensor-IC is exchangeable – in case of an overload the user can exchange the damaged IC by himself.

due to interference, or whether data are being retransmitted at unusual frequency, etc.

3.5 Analogue signals

Especially in systems that use analogue data acquisition and digital processing, it is important to verify whether the disturbance lies in the analogue quantity or in the digital processing.

Figure 6 shows the output voltage of an operational amplifier that has RF coupled into its input, which demodulates and amplifies the 1 kHz signal. This demodulation can occur at practically every pn junction. The degree of disturbance is affected by the extent to which the EUT itself amplifies the demodulated disturbance voltage.

4 SUMMARY

Using fibre optic technology and small, interference-immune sensors, it is possible to measure signals in the EUT without feedback or error during interference immunity testing. In the case of digital systems, a simple counter is often sufficient for evaluating the behaviour of the EUT and detecting interference.

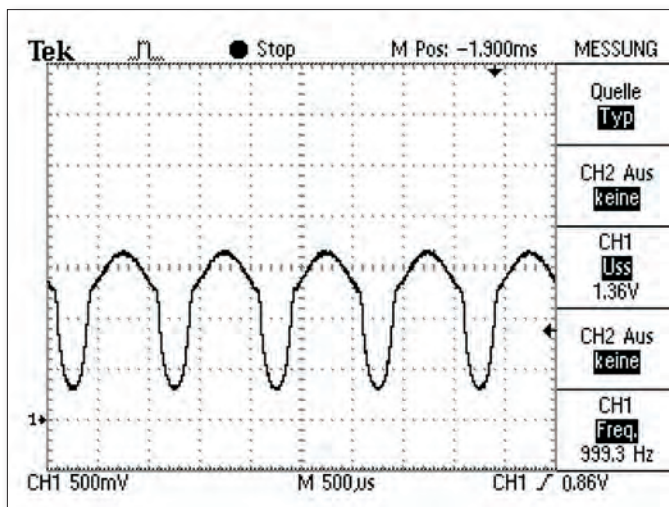

FIGURE 6: Demodulated 1 kHz interference signal at the output of an op-amp

How Much ESD Can an IC Bear? IC Immunity Tests Performed Under the Influence of ESD

SVEN KONIG

EMC Engineer
Langer EMV-Technik GmbH

NOWADAYS, ELECTRONIC devices have to meet the highest standards in terms of ESD immunity. "According to estimates of TÜV NORD, the manufacturing industry incurs costs amounting to millions of euros every year due to electrostatic discharges. ESD effects lead to circuit failures which in turn bring a vehicle, a process or a production line to a halt." An electronic system must be able to function reliably and without failure even under the severest conditions.

But at best an electronic system is only as good as its individual components, which must consequently meet these high demands too. A special point of interest is integrated circuits (ICs), which hardly any of today's electronic systems can do without. But which tests are available in practice to evaluate ICs in terms of their ESD immunity and how are these tests carried out?

Metallic housings and complex EMC measures such as ground layers, filters, etc. are often used to make modules or devices immune to ESD. These methods are very expensive and require a great deal of development work. Conventional EMC measures are usually only used for the prototype or at a very late development stage of the module or device, and even then, only if the compliance test has shown that the device's immunity is inadequate. These measures are taken to ensure the device's functionality. A much better solution, however, would be to subject the components intended for use such as ICs, connectors, etc. to comprehensive EMC analyses and especially to an ESD test right from the beginning even before the electronic development process starts. This would allow the developer or designer to make plans on how and where to use the components on the basis of their robustness and help him save time and cut development costs.

There are usually two different approaches that can be chosen in practice to ensure a module's or device's EMC.

In the first approach, the device is developed up to the initial sample or prototype. At this development stage the device is subject to an EMC compliance test where the EMC requirements are defined for the complete system. Potential weak points such as inadequately dimensioned connectors or sensitive ICs are only discovered in this compliance test and it will not be easy to modify them at this stage. The entire device or the module will be unable to achieve the defined EMC objectives so that comprehensive redesign

work will be necessary, which in turn will entail a loss in development time and additional EMC measures.

In the second approach, which is better, a separate EMC test is carried out for each of the planned components before the development process starts. This helps the developer determine their EMC parameters and assess if they suit the actual EMC demands of the entire system. It is thus possible to select appropriate components for a robust electronic design when the development is being planned.

ICs are particularly important for the EMC immunity of modules and devices. The IC's are becoming smaller and smaller and their clock rates faster and faster. The operating voltages as well as the associated operating points are being constantly reduced for energy efficiency reasons. This often makes ICs the weak points of the entire system and it is thus particularly important for them to satisfy the defined EMC requirements. For this reason EMC tests have to be carried out on ICs to ensure the functionality of the entire system.

The test procedures for ICs must be based on the compliance tests for devices. But conventional compliance tests cannot be used directly for ICs since the disturbances defined in the standard do not become effective on the IC during a compliance test on the module. The standard disturbance that is coupled into the device with a disturbance generator from outside subjects the IC and its line networks to magnetic and electrical fields. Due to this effect, namely magnetic and electrical coupling, the disturbances at the IC differ from the standard disturbances in terms of form, amplitude and mode of action. IC test procedures thus have to be redefined as separate test procedures.

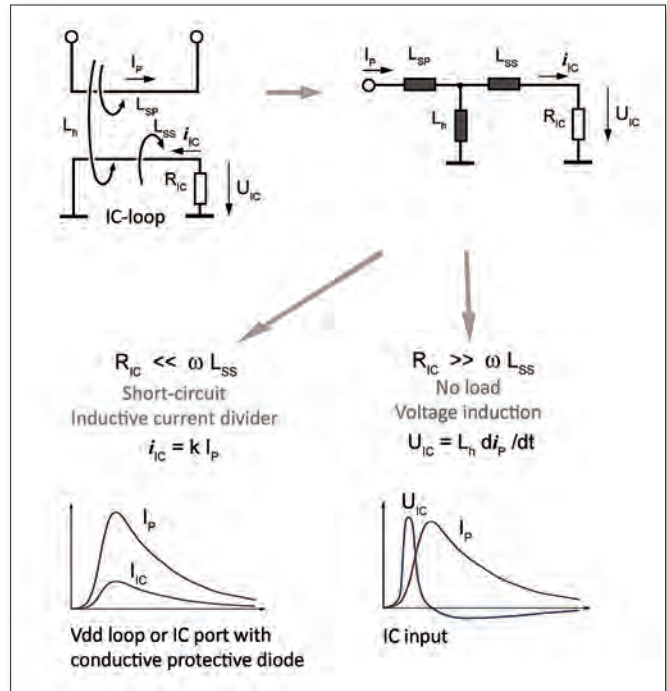

FIGURE 1: Coupling mechanism of the magnetic field.

Apart from the desired standard pulse, parasitic fields are similarly generated directly by the generator which may also interfere with the device as a whole or its individual parts. These unwanted electrical and magnetic fields essentially depend on the type and position of the ESD generator. This may lead to a great deal of inaccuracy in device tests. Even the direct ESD tests on individual IC pins carried out by some IC manufacturers are thus inaccurate and cannot be reproduced.

Disturbances therefore have to be defined at the circuit on the basis of magnetic and electrical coupling. In the event of magnetic interference, the disturbance current generates a corresponding magnetic field in the device. A disturbance voltage can be induced in existing loops (e.g. line networks). This disturbance pulse drops on high-impedance IC inputs and interferes with these. Furthermore, the disturbance can also affect other areas within the IC such as PLL, core, etc. The supply system, low-impedance signals as well as lines that are capacitively connected to the ground or Vcc, for example, are critical lines when it comes to interference through magnetic fields.

The magnetic coupling effect can be compared to a transformer (Figure 1). Interference with the IC's low-impedance Vdd loops results in an inductive current divider. The disturbance current generated by the disturbance generator is transferred to the IC's line networks. Interference with IC inputs that are connected at low impedance leads to the differentiation of the disturbance pulse if a magnetic field is applied. The induced voltages have much faster rise times and are shorter than the actual disturbance generated by the ESD generator. Today's circuits are fast enough to evaluate these differentiated disturbances (< 1 ns) and to be affected by them.

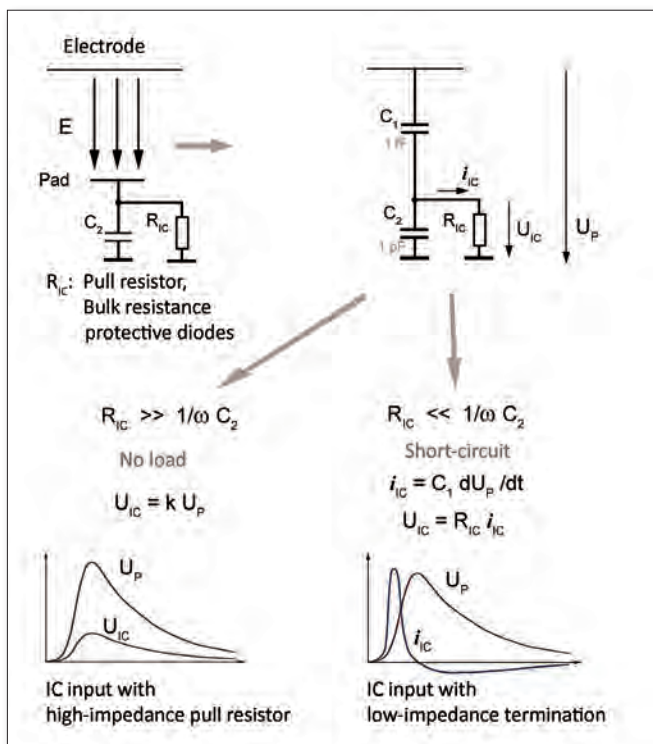

FIGURE 2: Coupling mechanism of the electrical field.

It is mainly lines with high impedance that are sensitive to electrical interference. The voltage difference between the circuit and its environment such as metal parts, ESD generator, etc. generates an electrical field that may affect the signals or the circuit. The resulting voltage pulse may lead to an interference with the IC depending on its sensitivity. Reset, clock, quartz, test pins or high-impedance measurement inputs of A/D converters, for example, are critical pins or lines.

The capacitance between the IC's line networks and its environment is the quantity that is decisive for the coupling mechanism of the electrical field (Figure 2). The disturbance is also differentiated if an IC input that is wired at low impedance is subject to capacitive interference. The disturbance pulse is transmitted directly via the capacitive voltage divider if the lines are connected at high impedance. The effects on the IC are ultimately similar to those caused by magnetic coupling.

Today's manufacturers usually test the resistibility of their ICs. These tests (e.g. HBM; MM; HMM) only ensure the IC's resistibility during production, for example. They have nothing to do with how an IC can be interfered with in its respective field of use. Tests that are based on standard burst and ESD tests are nowadays used to ensure an IC's trouble-free operation. The transient injection method (IEC-62250-3) requires that disturbance pulses from the standard burst generator are applied directly to the IC pins. This generator, however, has no matched line termination and the measurement set-up is electrically

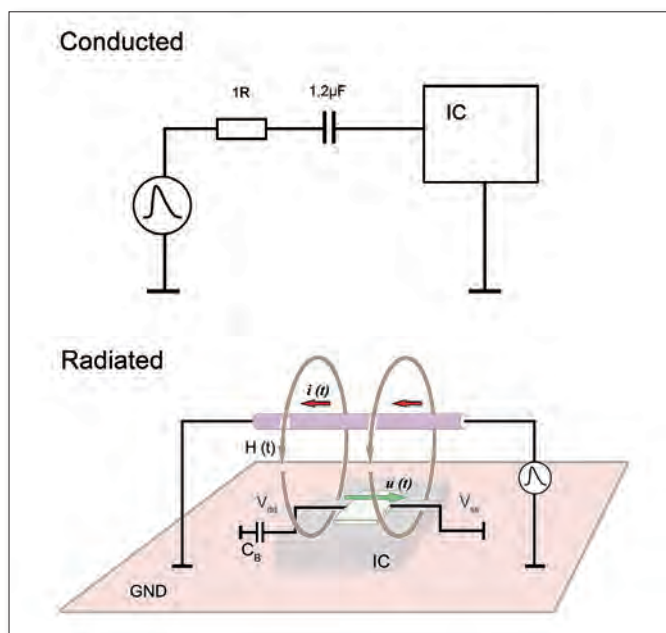

FIGURE 3: Magnetic coupling; simulation with a very low-impedance source ($R \ll 50 \text{ Ohm}$).

long resulting in undefined disturbances. Instead of using the disturbance current and/or disturbance voltage directly at the pin, the no-load voltage at the generator is used to evaluate the IC's immunity. The disadvantage of this method is that it allows no conclusions on the IC's sensitivity to electrical or magnetic fields. The powered ESD susceptibility test (also HMM) requires that the ESD pulse is applied directly to the IC pin. This disturbance will not occur in this way at the IC in practice. Furthermore, unwanted electrical and magnetic disturbance fields, are generated at the ESD generator which will also affect the IC under test. This makes the tests hard, if not impossible to reproduce.

Useful test procedures must simulate the physical principles of action in the device. A very low-impedance source ($R \ll 50 \text{ Ohm}$) is required to simulate magnetic coupling into the IC pin. This allows the generation of a disturbance as occurs in IC use through voltage induction in the IC or at the line networks (Figure 3). A disturbance generator with a very high impedance is required to simulate electrical coupling ($R \gg 50 \text{ Ohm}$). In conjunction with a very low coupling capacitance, this allows the simulation of electrical interference (Figure 4).

The IC test system allows the user to perform different test procedures on the circuits without interaction and in a reproducible way.

The IC is mounted on a test board and connected to all necessary and/or wanted signals and a power supply. This test board enables an EMC compliant connection of the device under test and contains all necessary filter

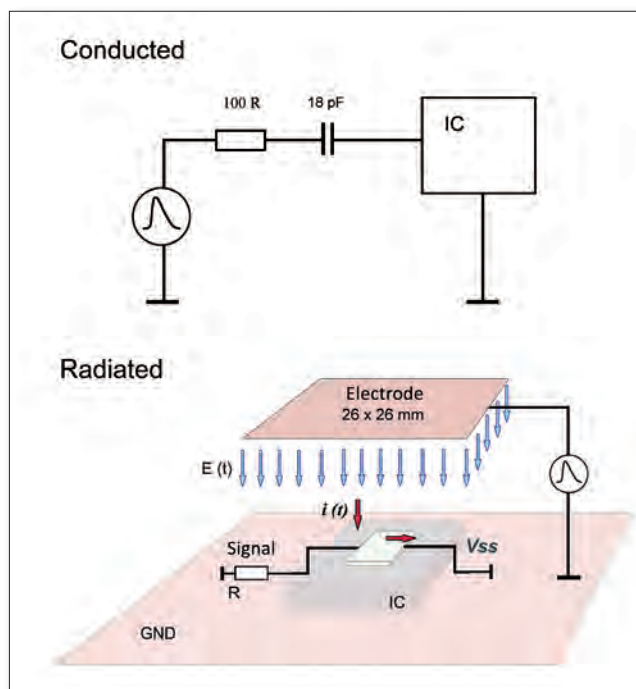

FIGURE 4: Electrical coupling; simulation with a high-impedance source ($R \gg 50 \text{ Ohm}$).

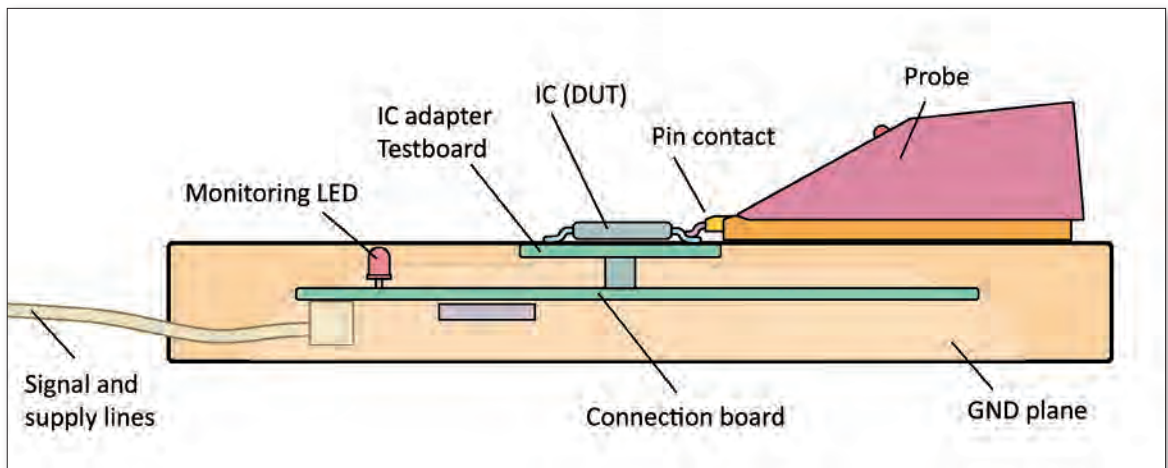

FIGURE 5: Measurement set-up with a probe to simulate the effects of magnetic coupling.

elements to ensure that the IC and its environment are decoupled. The test board is connected to the connection board. The connection board is a unit that is used to control and monitor the device under test (IC). The test board and the connection board are located in the ground plane. The ground plane is the reference ground for the tests. The device under test and the corresponding test systems (probes) can thus be properly connected under RF conditions and the measurement set-up is confined to a small space. The probes are suitable to perform both emission measurements and immunity tests (Figure 5). They are placed on the ground plane and connected to this at low impedance. The probe allows the user to contact any pin flexibly and directly. The complete measurement system is contained in the probe and does not have to be integrated in the layout of the test board.

Different probes can be used to simulate the ESD principles of action mentioned in the first part of this article. A very low-impedance pulse generator is integrated in the current probes to simulate the effects of magnetic interference that affect the IC in practical use under the influence of ESD. The interference mechanisms caused by electrical fields can be simulated with the voltage probes. These have high impedance and a very low coupling capacitance. The test system enables the developer to contact an individual pin and determine the different electrical and magnetic interference levels of a pin through an automatic test procedure if necessary. Apart from conducted IC test methods, a variety of systems for radiated measurements (RF, ESD, Burst) are available.

The IC test system has the following benefits for the users:

- the EMC parameters of individual components can be compared directly
- components can be selected for specific layouts

- the immunity behaviour of components can be predicted

Similarly, the IC manufacturers can benefit from testing their circuits with the IC test system:

- the EMC parameters of existing ICs can be verified
- causes of disturbances can be clarified
- IC optimisation processes can be carried out with the IC test system in an efficient and expedient way

The IC test system is suitable to perform all IC measurements/tests (compliance measurements as well as measurements during development) and to determine all relevant EMC parameters of ICs.

AUTHOR BIO

Sven König is responsible for the test and measurement equipment for electronic semiconductors at Langer EMV-Technik GmbH in Bannewitz. König was born in Dresden and studied electrical engineering at the "Studienakademie" in Bautzen. He has been an engineer at the Langer EMV-Technik GmbH since 2007.

New EU Requirements and Test Methods for 2.4 GHz ISM Data Transmission Equipment

DAVID ZHANG
NIMA MOLAEI
LESLIE BAI
EMC Test Engineers
SIEMIC Laboratories

ABSTRACT

NEW EUROPEAN Union Directive requirements have been introduced for 2.4GHz ISM (industrial, scientific and medical) Data Transmission Equipment, which will be in effect starting January 1, 2015. This article presents an overview of the regulatory compliance requirements, and provides a detailed analysis on the differences between the current standard ETSI EN 300 328 V1.7.1 (2006) and the new standard ETSI EN 300 328 V1.8.1 (2012). Also included is an introduction to the new required test methods, as well as some of the unique test setups.

Keywords – EU, European Union, R&TTE, ISM, ETSI, EN 300 328, SIEMIC

INTRODUCTION

To regulate the consumer marketplace and protect the residents in the European Union (EU), regulations, directives, deci-

sions, recommendations and opinions are developed and negotiated among the member states. These legislative requirements cover various product aspects, including safety, health, and environmental protection, as well as protecting the public infrastructure, such as the telecommunications systems and frequency spectrum. In May 1985, the EU "New Approach to Technical Harmonization and Standards" was defined, which represented an innovative way to achieve technical harmonization. It clearly introduced the separation of responsibilities between the European Commission (EC) legislators and the European standards bodies in the legal framework, including the European Committee for Standardization (CEN), the European Committee for Electrotechnical Standardization (CENELEC) and the European Telecommunications Standards Institute (ETSI).

Basically the EC directives define the essential requirements, and the EU standards bodies have the responsibility to develop the corresponding technical specifications needed to meet the essential requirements of the directives, which are called standards. These approved standards are published in the EC Official Journal (OJ), and become the EU harmonized standards. Compliance with these standards provides a presumption of conformity with the applicable requirements of the harmonized legislation. Thus manufacturers, conformity assessment bodies, and other participating economic operators can use these harmonized standards to demonstrate that products, services, and processes comply with the

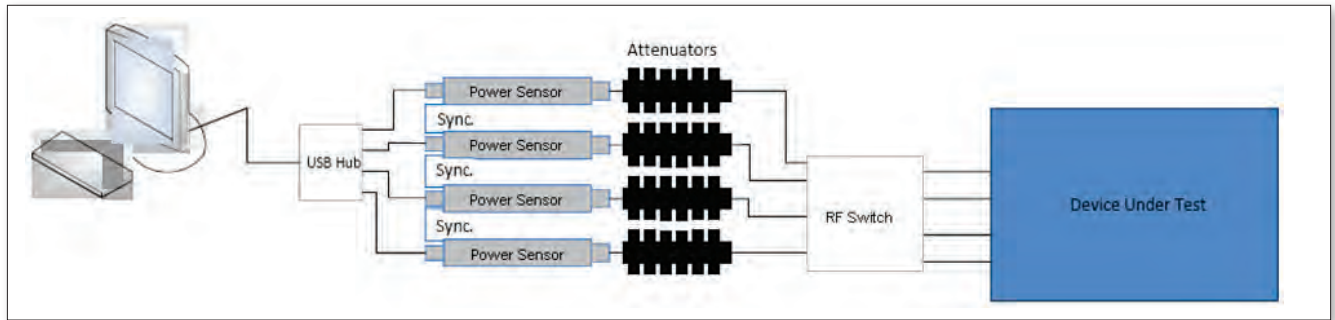

FIGURE 1: Test Setup for RF Output Power Testing

relevant EU legislation.

The three standards bodies CEN, CENELEC and ETSI are responsible for the preparation of Harmonized Standards under the EC's Radio and Telecommunications Terminal Equipment (R&TTE) Directive (1999/5/EC), which was published in the EC OJ on 7 April 1999. The Directive covers all radio and telecom equipment intended to be connected to public telecommunications and radio networks in the EU.

In June 2012, ETSI updated two standards that were added to the EC OJ in October 2012, which take effect on January 1, 2015, becoming the official harmonized EU standards on this effective date. These two standards are:

- ETSI EN 300 328 V1.8.1- Data transmission equipment

operating in the 2.4 GHz ISM band and using wide band

modulation techniques;

- ETSI EN 301 893 V1.7.1- 5 GHz high performance WLAN;

These two standards cover a wide range of products, including WLAN, Bluetooth, ZigBee, 2.4 GHz remote control, and Fixed PTP products. Both of the ETSI standards provide a presumption of conformity (or compliance) with Article 3.2 of the R&TTE Directive. However the current versions of these standards will cease to provide a presumption of conformity on 31 December 2014, so the EU Declarations of Conformity (DOC) for the R&TTE Directive based on the standard EN 300 328, V1.7.1 would need to be re-evaluated before the end of 2014 against the new V1.8.1 standard.

In this paper, we will focus on the standard EN 300 328 V1.8.1, which has significant changes compared to the current V1.7.1 version, in both of the technical requirements and the test methods to be used to evaluate compliance.

II. DETAILED ANALYSIS OF EN 300 328: V1.7.1 VS. V1.8.1

As mentioned, there are a lot of updates in the V1.8.1 version of ETSI EN 300 328. The reasons given for this standard update are to improve the usage and quality

of data transmission equipment operating in the 2.4 GHz ISM band, and to make the standard more generic, in order to cover all different possible product types.

ETSI EN 300 328 V1.7.1 was added to the Official Journal as a harmonized standard in December 2009. This version added a spectrum sharing requirement, stating that a medium access protocol must be implemented, targeted for equipment designs based on an international standard protocol, such as IEEE (Institute of Electrical and Electronics Engineers) 802.11, IEEE 802.11n, or IEEE 802.15.4.

There wasn't a clear test methodology defined for the spectrum sharing in V1.7.1, which has resulted in a lot of misunderstanding and confusion. Test labs aren't always sure how to evaluate for these compliance requirements, and usually will have to rely on a declaration from the manufacturer to state that the equipment is equipped with a mechanism to utilize the spectrum sharing. But some manufacturers don't want to provide this type of declaration, because they assume the test lab should evaluate and provide the conclusions concerning compliance.

This causes difficulties when equipment is to be tested per this standard, and a good solution isn't known. For Wi-Fi, Bluetooth, and ZigBee devices, which were designed with specific spectrum sharing mechanisms implemented per the IEEE protocol, compliance can be achieved based on the declaration. But for those cases where the equipment is not designed to a standard IEEE protocol, how can the spectrum sharing capability be evaluated?

This situation will be addressed with the adoption of the new V1.8.1 standard version. The Medium Access Protocol will be replaced by adaptivity testing requirements, and the new version has detailed technical requirements on the interference detection threshold and timing. It will also provide step-by-step testing procedures, making the new requirements to be more efficiently followed.

The following options for spectrum sharing mechanism are included in V1.8.1:

- For Frequency Hopping Spread Spectrum (FHSS) systems
 - o Adaptive Systems
 - Listen Before Talk (LBT) based Detect and Avoid (DAA)

- Other forms of DAA (non-LBT)
- Non-Adaptive Systems
 - Medium Utilization (MU)
- For non-FHSS systems (anything else)
 - Adaptive Systems
 - LBT based DAA
 - Other forms of DAA (non-LBT)
 - Non-Adaptive Systems
 - Medium Utilization (MU)

Additional changes were made on other requires tests, with the purpose of making the standard more generic, in order to cover the different equipment types operating in the 2.4 GHz frequency band. The technical requirements are separated into two major wide band equipment types. The first is FHSS (Frequency Hopping Spread Spectrum) equipment, and the second is Wide Band Modulation equipment other than FHSS.

In Table 1 you will find a brief summary of the major differences in the technical requirement between EN 300 328 V1.7.1 and EN 300 328 V1.8.1. These major changes in version V1.8.1 are:

- *RF Output Power*: New test instrument requirements, and new test procedures are added, plus consideration for MIMO (Multiple Input, Multiple Output), but the limits remains the same.
- *Unwanted Transmitter Emissions*: Adds the requirements for Out Of Band (OOB) domain emissions, and defines a frequency range that extends two bandwidths away from the operating frequency. The corresponding test procedure is also defined. For spurious emission domains, the measurement detector is changed, and requires using high resolution points during while sweeping, in order to obtain accurate test data. Finally, the pre-scan and final measurements are defined separately.
- *Power Spectral Density*: This has been normalized to the power measurement results obtained, and the new test procedure requires extensive calculation, but the limits remain unchanged.
- *Frequency Range*: The test procedure has changed to use a 99 percent bandwidth measurement, to be performed only at nominal conditions.
- *Adaptivity and Receiver Blocking*: Adaptive and non-adaptive devices operating at more than 10 dBm e.i.r.p, (equivalent isotropically radiated power) are now subject to new timing restrictions. In addition, adaptive equipment will need to be able to detect interference, and cease transmission when interference is detected.

TEST METHODS TO SUPPORT ETSI EN 300 328 V1.8.1

Together with the changes to the technical require-

ments, the test procedures are also re-defined to provide more appropriate methods to evaluate product compliance. The test procedures are also becoming more generic, so they can be used for different types of equipment.

Environmental Conditions

The conditions for testing are changed from V1.7.1, where the extreme environmental conditions and extreme power source criteria had to follow the requirements as described in clause 5.3, but in V1.8.1, they are declared by the manufacturer, based on the actual operating condition for the equipment.

Unit Under Test (UUT) Operating Conditions

For the operation conditions of the UUT per V1.8.1, it needs to be configured for the normal operation mode, which means the UUT may have an inconsistent duty cycle, and different transmission characteristics, depending on the equipment type and specific operating mode. In the current V1.7.1 version, the UUT should be configured as a continuous transmission test mode (100% duty cycle). The problem is, this kind of mode requires using special tools or software from the manufacturer, which sometimes is difficult to obtain; and the actual real-life RF performance of the equipment may not match what it's expected to be during the normal operation mode used during compliance testing. There is also the potential for "fudging" the results by using the special test mode prepared by manufacturer intentionally with the sole purpose of enabling the UUT to pass testing. The new rule in V1.8.1 effectively addresses this issue, and requires all measurements to be performed in the normal operation mode, thus making the measurements consistent and more accurate.

RF Output Power Measurement

For RF output power measurement, a fast power sensor suitable for 2.4 GHz and capable of 1 MS/s (Mega Samples per second) must be used. The measured sample must represent the power of the signal. The measurement duration is defined for both non-adaptive and adaptive equipment, in order to improve accuracy. While either the radiated or conducted measurement method can be used, they all need to follow similar data acquisition steps to obtain the results.

- For conducted measurement on devices with one transmit chain, sample the transmit signal, and store the raw data.
- For conducted measurements on devices with multiple transmit chains, measurements needs to be made at all transmit ports simultaneously, and the power of the individual samples of all ports needs to be stored and summed For radiated measurements, the UUT must be configured and antenna(s) positioned for maximum e.i.r.p. levels towards the measuring antenna, including smart an-

TABLE 1: DIFFERENCES IN THE TECHNICAL REQUIREMENTS BETWEEN ETSI EN 300 328 VERSIONS V1.7.1 AND V1.8.1		
Test Item	EN 300 328 V1.7.1(2006-10)	EN 300 328 V1.8.1(2012-07)
Equipment Types	FHSS and DSSS	FHSS, other Wide Band modulation, adaptive and non-adaptive equipment.
RF output Power	100mW maximum e.i.r.p	100m W mean e.i.r.p (need to consider beam forming gain)
Power Spectral Density (non-FHSS only)	10Bm/MHz maximum e.i.r.p spectral density	10dBm/MHz, mean e.i.r.p. spectral density
Duty Cycle, TX-Sequence, TX-Gap	Not defined	Duty Cycle shall be equal to or less than the maximum value declared. - For FHSS: max TX-sequence time ≤ 5 ms, min TX-Gap time ≥ 5 ms - For non-FHSS: TX-sequence time = Min. TX-Gap time = M (Note: 3.5mS < M < 10mS)
Dwell time, Minimum Frequency Occupation and Hopping Sequence (FHSS only)	Frequency Hopping requirements: Dwell time < 0.4s Hopping channel, Hopping sequence	Dwell time, Minimum Frequency Occupation and hopping sequence Hopping frequency separation: new limits
Medium access protocol	A medium access protocol shall be implemented	Medium Utilization factor only for Non-adaptive equipment with and EIRP > 10mW; Limit: ≤ 10%
Adaptivity	No requirement	Only for adaptive equipment with e.i.r.p > 10 mW
Occupied Bandwidth	No requirement	99% OBW shall fall within the used band. FHSS and Non-AFH equipment (e.i.r.p > 10 dBm): Occupied Channel Bandwidth ≤ 5 MHz Non- FHSS and non-AFH equipment (e.i.r.p > 10 dBm): Occupied Channel Bandwidth < 20 MHz
Transmitter unwanted emission in the Out Of Band domain	No requirement	Specified the limit mask for out of band unwanted emissions.
Transmitter spurious emissions	Defined	Limit unchanged, but the measurement setting of RBW and detector changed.
Receiver spurious emissions	Defined	Limit unchanged, but the measurement setting of RBW and detector changed.
Receiver blocking	No requirement	only for adaptive equipment with EIRP > 10mW

tenna systems and systems capable of beam forming.

The fast power sensor is also required for the measurement; a spectrum analyzer should not be used.

The start and stop times of each burst are stored, and should be used to calculate the RMS (Root Mean Square) power over the burst period. The maximum e.i.r.p. calculation to determine the RF Output Power (P) sums three measured values, the highest Pburst value (A), antenna assembly gain (G) and the additional beam forming gain (Y), as given by the formula:

$$P = A + G + Y$$

The use of fast power sensors and simultaneous measurements for MIMO chains eliminates the possibility of using an alternative method for the power measurement. The special and unique power sensors which can comply with the requirement per V1.8.1 are becoming very hot commodities in the test equipment market. We will now

talk about the method for the major test items.

The testing of RF Output Power will be based on the use of fast power sensors, and may require 4 power sensors to work simultaneously for 4x4 MIMO devices. A suggested test setup is shown in Figure 1.

Power Spectral Density

The Power Spectral Density (PSD) can be measured using a high resolution spectrum analyzer. The detector to be used has been defined specifically as an RMS detector, instead of an average detector referenced in version V1.7.1. The sweep points in the measurement frequency range are defined to make sure the necessary accuracy is achieved. If the spectrum analyzer used does not support enough sweep points, the frequency band can be segmented.

Per the procedure defined in V1.8.1, the PSD measurement is not simply sweeping on the spectrum analyzer and marking the highest amplitude. A sweep is made with a Resolution Bandwidth (RBW) of 10

KHz and a Video Bandwidth (VBW) of 30 KHz, utilizing a RMS detector, while capturing more than 8350 sweep points. Next, all the values in the sweep need are summed and normalized to RF Output Power e.i.r.p. units to obtain the normalization factor, which will incorporate all the individual values to produce the normalized amplitude. This measurement is made starting from the first sample in the file (lowest frequency), then adding up the power of the following samples in 1 MHz segments, and recording the results for power and position (i.e. sample #1 to #100), then repeating measurements by shifting the start point of the samples by 1, then repeating the procedure for all individual values until the all values have been covered. The highest resulting 1 MHz segment sample that results will be the maximum PSD value.

Transmitter Spurious Emissions in the Out of Band Domain

This is a new item added in the V1.8.1 version. The purpose is to limit the unwanted transmitter emissions in the Out Of Band (OOB) domain on frequencies immediately outside the required bandwidth, which results from the modulation process, but excludes spurious emissions. This measurement is performed by using the Time Domain Power Measurement function on a spectrum analyzer. The measurement detector is set for RMS, and at least 5000 sweep points are required.

The measurement frequency range depends on the UUT's Operating Bandwidth (OBW), from (2400 MHz – 2BW) to (2483.5 MHz + 2BW). With a Resolution Bandwidth (RBW) of 1 MHz and SPAN set to 0 Hz, the Time Domain Power measurement needs to be repeated at each center frequency that is 1MHz from the edge of each defined ISM (Industrial, Scientific and Medical) band frequency range. Similar to the RF output power measurement, the declared antenna assembly gain "G" in dBi must be added to the results for each of the 1 MHz segments. For equipment with multiple transmit chains, the measurements need to be repeated for each of the active transmit chains. The highest value in each 1 MHz segment is the highest transmitter spurious emissions in the OOB domain.

Adaptivity and Receiver Blocking

One of the most important changes in the V1.8.1 is the addition of an Adaptivity and Receiver Blocking testing requirement, which tests how equipment adapts to its environment by identifying other transmissions present in the band, then "adapting" by excluding them its selected frequencies and channels of operation.

The adaptivity is part of the requirement for spectrum sharing. It used to be called "Medium Access Protocol Mechanism" and mainly relied on the manufacturer's declaration. WLAN or ZigBee products are designed per standards such as IEEE 802.11 or IEEE Std. 802.15.4, and will have a LBT spectrum sharing mechanism based on the Clear Channel Assessment (CCA)

mode that detects RF energy, so they can comply with the spectrum sharing requirement. However, there are detailed technical requirements and test procedures defined in V1.8.1 for the purpose of evaluating devices that do not have this type of standardized spectrum sharing mechanism implemented. The concept of adaptivity is also complicated by the depth of detail necessary in the standard so it will be generic enough to cover different adaptive equipment types that may be introduced.

During the testing, a Wide Band noise signal is injected into the UUT's antenna port, such as an interference signal centered on the hopping frequency or the operating frequency being tested. The interference signal must be a band limited noise signal that has a flat PSD. Usually this kind of signal is to be generated by the Adaptive White Gaussian Noise (AWGN) generation function on a vector signal generator.

The adaptivity and receiver blocking tests are combined and performed together, and a typical test configuration can be seen in Figure 2. The test procedure contains the following basic steps:

Step 1: Connect the UUT and companion devices, then connect the interference signal generator, the blocking signal generator, and the spectrum analyzer. The spectrum analyzer is used to monitor the transmissions of the UUT in response to the interfering and the blocking signals.

Step 2: Configure the UUT for normal transmissions with a sufficient load that allows the demonstration of compliance of the adaptive mechanism on the hopping frequencies tested. Then verify the UUT's Channel Occupancy Time and minimum Idle Period.

Step 3: Add in the interference signal.

Step 4: Verify the spectrum sharing mechanism's reaction to the interference signal.

Step 5: Add in the blocking signal, and verify the UUT's reaction.

Step 6: Remove both the interference and blocking signals, then verify the UUT's reaction.

Note that the UUT is allowed to transmit control signals after the detection of interference signal, as long as the duty cycle of control signal does not exceed the limit given in the standard.

A typical test setup for adaptivity and receiver blocking testing is shown in Figure 2.

UNIQUE TEST SETUP CHANGES IN ETSI EN 300 328 V1.8.1

The EN 300 328 V1.8.1 standard specifies the requirements for measurement test instrument functions, performance and settings, which are quite different from the V1.7.1 requirements. Some of the more unique test

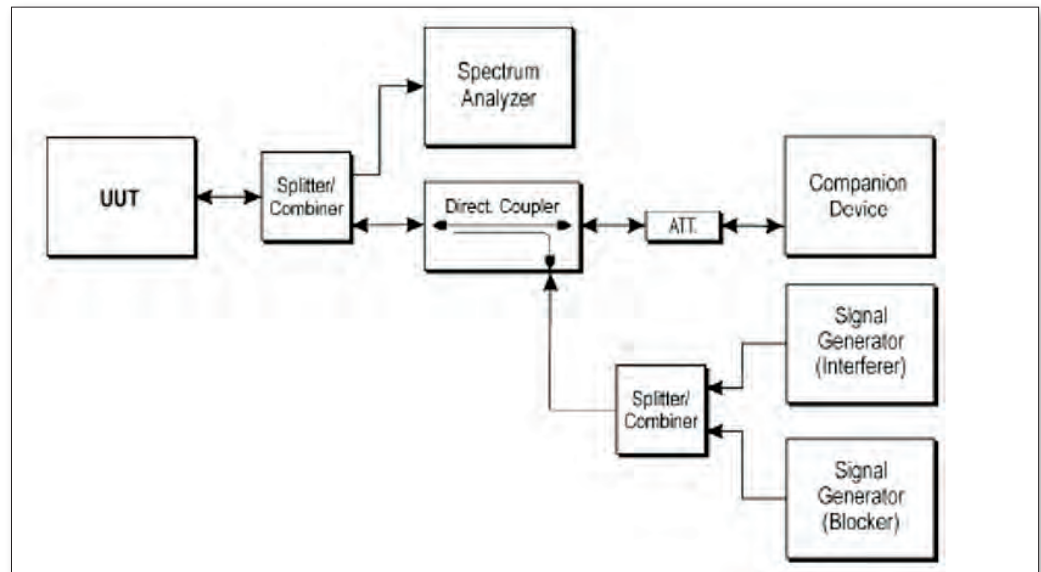

FIGURE 2: Test setup for Adaptivity and Receiver Blocking testing

equipment requirements include:

- Fast power sensors suitable for 2.4GHz, and capable of 1 MS/s for RF Output Power measurements, and it needs to support simultaneous measurements on MIMO devices.
- Higher performance spectrum analyzers with over 30,000 sweep sample points for Dwell Time, Minimum Frequency Occupation, and Hopping Sequence measurement
- Spectrum analyzers with RMS detectors for most measurements
- Time Domain Power Measurement functions for transmitter spurious emissions in the OOB domain
- Wide band noise sources for interference signals must have less than 1.5 dB ripple for Adaptivity testing

Also note that an Adaptive White Gaussian Noise (AWGN) generator to support noise bandwidths above 160 MHz will be required if the testing is to be performed on an 802.11ac device with 160 MHz bandwidth.

Table 1 compares the changes for twelve key test criteria between the current ETSI EN 300 328 V1.7.1 and the soon to be implemented ETSI EN 300 328 V1.8.1.

FUTURE DEVELOPMENTS FOR ETSI EN 300 328

While manufacturers and testing labs are currently transitioning to the EN 300 328 V1.8.1 standard, ETSI has already published the draft version of EN 300 328 V1.8.2. This version is currently in the European Norm standards approval process, with a resolution meeting

scheduled in September, 2014, to be followed by an additional national vote on the modified version, if there are comments. The final version that passes the national vote will be published as EN 300 328 V1.9.1, which is expected to happen sometime in 2015.

Some possible changes in the future version V1.8.2 could include:

- For FHSS, there are proposed changes on some definitions, such as dwell time, as well as some technical requirements and corresponding test methods.
- For non-FHSS and LBT based adaptive system, such as IEEE 802.15.4 and IEEE 802.11, the requirements and test methods for adaptivity testing will be clarified. Formulas for calculating 'Extended CCA time' and 'Channel Occupancy Time' have been removed and replaced by fixed values, or a range of fixed values.
- Changes to the spurious emission tests for the detector type instrument setting, including a clarification that the radiated testing needs to be performed on the UUT, even if RF conducted testing is performed.

REFERENCES

- URL: www.siemic.com
- URL: www.etsi.org
- ETSI EN 300 328 V1.8.1: 2012
- ETSI EN 300 328 V.8.2: 2014 (Draft version)
- Presentation on EN 300 328 & EN 301 893, R&TTE CA meeting – Amsterdam – May 2014
- Article 288 of the Treaty on the Functioning of the European Union

JAN SROKA

Professor
University of Warsaw

ABSTRACT

THERE IS STILL BIG improvement potential in reproducibility by EMC testing. CISPR groups permanently work on it. The document CISPR 11 + A1 in act is issued in 2010. It is already in general maintenance revision which will supersede the existing one in 2015. New regulations included in this document such as: mandatory application of the Common Mode Absorbing Devices, precise definitions of the EUT volume and the small EUT surely will improve reproducibility of the radiated emission. The same concerns the treatment of the special earthing terminal by conducted emission if ambiguity, which is evidently an oversight, will be eliminated

INTRODUCTION

The document CISPR 11 + A1 in act is issued in 2010. It is already in general maintenance revision which will supersede the existing one in 2015. Many

regulations which improve reproducibility of the measurements are included in it. Among others there are:

- mandatory usage of the Common Mode Absorbing Devices by radiated emission measurements up to 1GHz,
- precise definition of the EUT volume,
- bonding of the earthing terminal.

The reader should get familiar with these requirements in order to adopt them just on time.

After years of discussions on the CISPR meetings, the experts agreed that common mode impedances of the lines connected to the EUT have significant influence on the radiated emission below 1GHz. Specially it concerns the small table top equipments. Therefore it is required to mount the Common Mode Absorbing Device CMAD on all lines i.e.: power input and output as well communication and signal lines. CMADs should stabilize the common mode impedance, independently on the termination impedance of the line.

In the document [2] technical specification of the CMAD are established. Document [3] is the first one according to which the usage of the CMAD is mandatory.

The CMAD can, but may not decide about the EUT volume. Definition of the EUT volume changes also definition of the antenna – EUT distance.

The term small EUT gives the decision criterion about ability of testing in the 3m distance. It is firstly introduced in the document [1]. However only precise definition of the EUT volume in document [4] eliminates interpretation ambiguity of this term.

In many cases the EUTs have additional earthing terminals, despite the PE strain in the mains cable. It concerns mainly the EUTs with big dimensions and big rated power, intended for industrial applications. In the existing documents there were no regulations on how to treat them. In consequence their test hoses interpreted this in different ways. The document [4] terminates this arbitrator by radiated emission but there is still ambiguity by conducted emission.

COMMON MODE ABSORBING DEVICE CMAD

According to the document [2] reflection coefficient S11 of the CMAD must be within the following limit range (red lines in Fig. 1):

- upper limit 0,75 at 30MHz and 0,55 at 200MHz, decreasing linearly with the logarithm of the frequency (continuous line in Fig. 1),
- lower limit 0,6 at 30MHz and 0,4 at 200MHz, decreasing linearly with the logarithm of the frequency (dotted line in Fig. 1).

Transmission coefficient S21 must be less than 0,25 in the frequency range from 30MHz to 200MHz (blue line in Fig.1). These coefficients are referenced to the characteristic impedance ZC of the cylindrical wire with d diameter, placed in the height h over the metal reference. It can be expressed as follows

$$(1) Z_c = \frac{Z_0}{2 \cdot \pi} \operatorname{ar} \cosh \left(\frac{2 \cdot h}{d} \right)$$

in which: Z0 – wave impedance of the vacuum.

Typical value of d is 4cm. The height h depends on the clamp construction. Characteristic impedances ZC for typical clamps are gathered in Table 1.

Asymmetric impedance of the line placed in the CMAD is as follows [5]

$$(2) Z_1 = \frac{(I + S_{11} \Gamma_L) \cdot (I - S_{22} \Gamma_L) + S_{12} \Gamma_L S_{21}}{(I - S_{11} \Gamma_L) \cdot (I - S_{22} \Gamma_L) - S_{12} \Gamma_L S_{21}} \cdot Z_c$$

by which: Γ_L – reflection coefficient, on the clamp

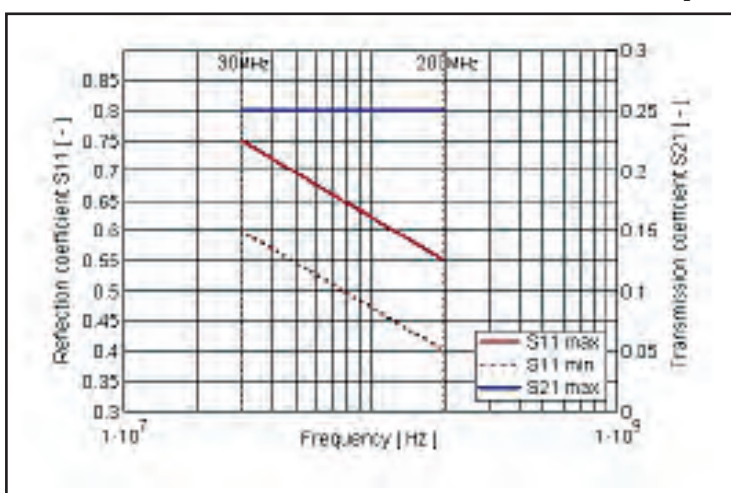

Figure 1: Limit ranges of the CMAD scattering coefficients.

h = 30 mm	ZC = 204 Ω
h = 65 mm	ZC = 248 Ω
h = 90 mm	ZC = 270 Ω

Table 1. Typical reference impedances by CMAD characterisation.

port opposite to the EUT port. It is consequence of mismatching with ZC.

For negligible small coefficients S12 and S21 it is simplified to

$$(3) Z_1 = \frac{1 + S_{11} \Gamma_L}{1 - S_{11} \Gamma_L} \cdot Z_c$$

Analysis of Eq. (2) and (3) leads to the conclusion that both requirements imposed on the CMAD are necessary. Coefficient S11 ensures required impedance Z1 on the EUT port. Small coefficients S21 = S12 makes this impedance insensitive on the termination impedance of the line on the side opposite to the EUT.

Neither Secondary Absorbing Devices SADs, used by the measurement of the emission of power according to CISPR 16-1-3, nor decoupling clamps recommended by the standard EN 61000-4-6 do not fulfil the requirements of the CMAD. For testing houses it means the new purchase.

Set-up for the measurement of the radiated emission up to 1GHz

Document [4] requires the CMAD by emission measurement up to 1GHz. These measurements are performed on the turn floor. The EUT along with the cables builds by rotation the virtual cylindrical volume called in the document [4] the EUT volume. An example of the set-up, according to [4] for the table top equipment is shown in Fig. 2 and for the floor standing equipment in Fig. 3. It is visible in Fig. 3 that positioning of the CMAD decides about the outer surface of the EUT volume.

In the document [4] the precise definition of the distance antenna – EUT is given.

It is unambiguously defined between the reference point of the LogPer antenna (phase centre [5]) and the outer surface of the EUT volume (distance L in Fig. 5). It has following influence on the set-up:

- the term: 3m, or 10m measurement set-up is no more sufficient characterisation of the ability of the chamber. It must be accompanied with the information about the maximal volume of the EUT which can be measured. For this volume the Normalised Side Attenuation NSA [6] must be verified. Usually this volume is equal or less than the diameter of the turn floor.

- The place of the antenna in the chamber is not fixed any more. It changes depending on the diameter of the EUT volume.

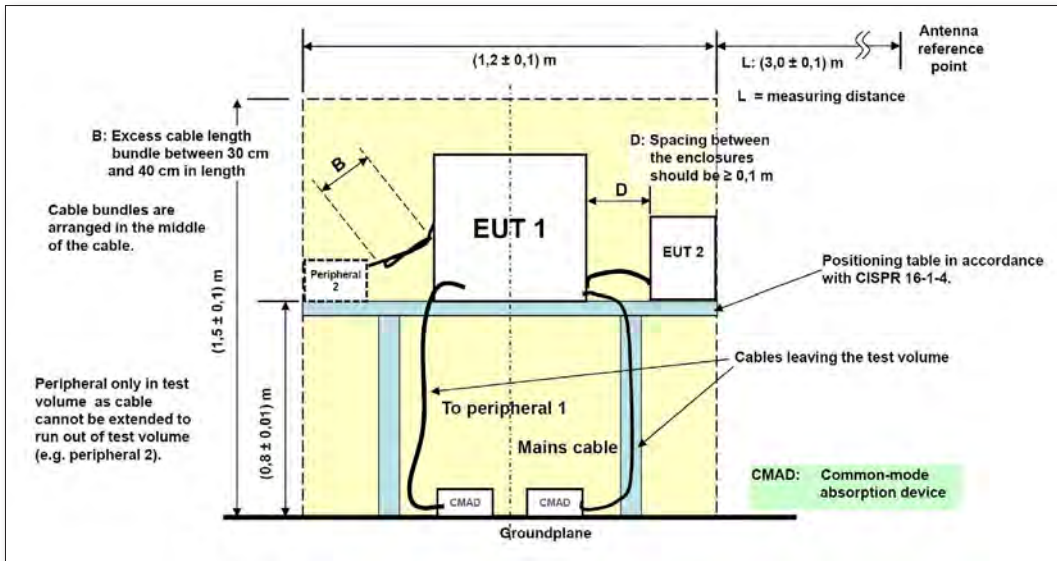

Figure 2: Set-up for the table top equipment acc. to [4].

EUT EARTHING

In document [4] for the first time special earthing terminal (chapter 8.1, 8.2, Fig. 3) is introduced. If the EUT is fitted with special earthing terminal, despite the PE strain in the mains cord, then this must be connected to the ground reference during radiated and conducted emission measurements with an as short as possible uninductive lead. However in the same document in chapter 7.5.3.2 in which the set-up for the conducted emission measurement is defined, two other earthing terminals are defined, namely:

- earth connections for safety purposes,
- other earth connections (e.g. for EMC purposes).

These earth connections should be connected to the reference earth point of the Artificial Mains Network AMN.

CONCLUSIONS

The document [4] in preparation introduces several new requirements which precisely describes the test setups by radiated and conducted emission measurements. It surely improves reproducibility of the measurements.

The document [1] gives the criterion according to which the EUTs can be measured in the 3m set-up (small EUT). However only precise definition of the EUT volume in document [4] gives no doubts in interpretation of the small EUT. This definitively terminates misusing of the 3m chambers for the measurement of not small EUTs. Moreover the term of the EUT volume enables the differentiation of the 10m chambers due to the volume with verified NSA.

The document [4] shows two excluding ways of the treatment of the earth terminals by conducted emission measurements. It is evidently oversight which can have significant influence on the measurement results. Hopefully the national CISPR Committees will see it and will cause correction of this ambiguity.

REFERENCES

- [1] CISPR 11 + A1: Industrial, scientific and medical equipment – Radio frequency disturbance characteristics – Limits and methods of measurement: 2010.
- [2] CISPR 16-1-4: Specification for radio disturbance and immunity measuring apparatus and methods - Part 1-4: Radio disturbance and immunity measuring apparatus - Antennas and test sites for radiated disturbance measurements. 2010.
- [3] CISPR 16-2-3: Specification for radio disturbance and immunity measuring apparatus and methods - Part 2-3: Methods of measurement of disturbances and immunity - Radiated disturbance measurements. 2010.
- [4] CISPR/B/598/CDV: Industrial, scientific and medical equipment – Radio frequency disturbance characteristics – Limits and methods of measurement: 2014.
- [5] Jan Sroka: Niepewność pomiarowa w badaniach EMC, pomiary emisyjności radioelektrycznej OWPW, Warszawa, 2009.
- [6] Jan Sroka: $|\Delta NSASAC| > 4\text{dB}$. - co dalej? Przegląd Elektrotechniczny R. 90 NR 7/2014, ss. 14 -17, 2014.

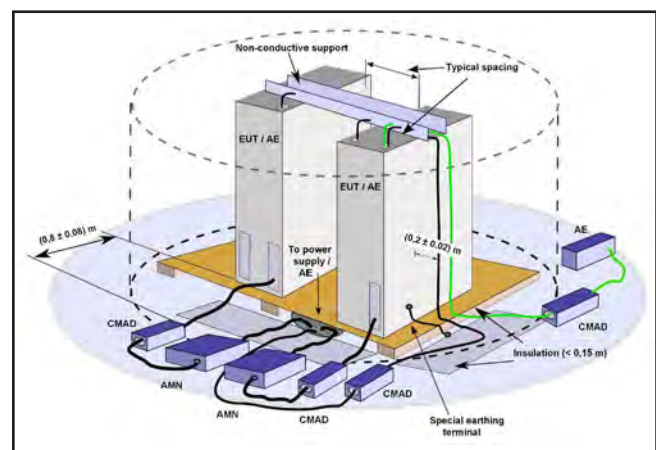

Figure 3: Set-up for the floor standing equipment acc. to [4].

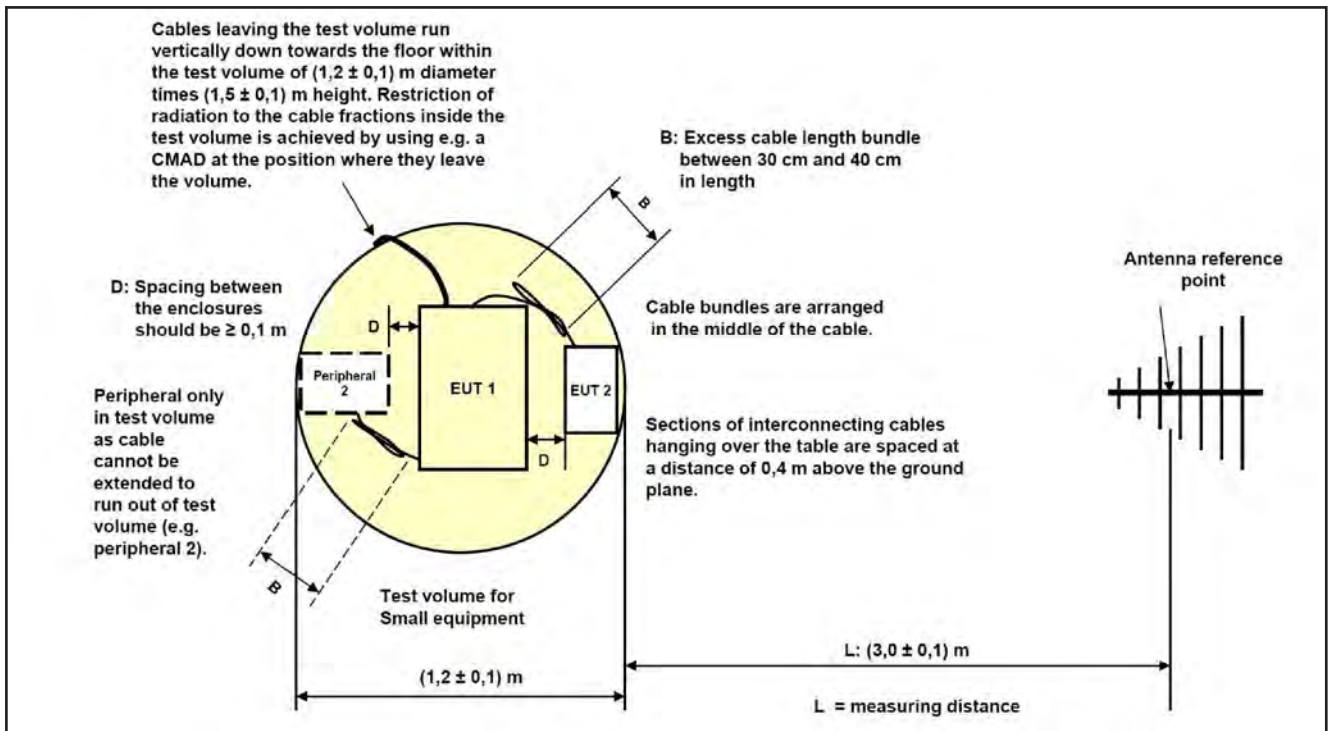

Figure 4: Measurement set-up along with the antenna acc. to [4].

AUTHOR BIO

Prof. dr hab. inż. Jan Sroka is with the Warsaw University of Technology, IETiSIP, Koszykowa 75, 00-662 Warszawa. He can be reached by email at J.Sroka@iem.pw.edu.pl and

with the EMC-Testcenter AG, Moosackerstr. 77, CH-8105 Regensdorf, Switzerland, e-mail: jsroka@emc-testcenter.com. He is also the EMC consultant by the company ASTAT Sp. z o. o. Poznań; visit www.astat.com.pl.

Stay in touch with the world of EMI/EMC news

Weekly Newsletter
Subscribe today at www.interferencetechnology.com

interference ITEM
THE INTERNATIONAL JOURNAL OF ELECTROMAGNETIC COMPATIBILITY | **technology**

Seeding and Harvesting

MART COENEN

Owner
EMCMCC

For many years national and international norms and standards have been established to make device and product design and manufacturing life easier or at least defined within bounds. In most cases, there is even a life-cycle process for the norms and standards themselves. Old ones fade away and new ones flourish, but some remain everlasting though new insights have proven otherwise. The standardization processes are to create references and stability or to set long lasting trade barriers. Test equipment manufacturers, test houses and industry want an economic return on their investments w.r.t. international standard development, test equipment development, and the accompanying constraints all these requirements have on the products and devices that have to adhere these established norms and standards.

ABSTRACT

CHANGING DESIGN REQUIREMENTS has a huge impact on product and device developments in electronic industries. But what if standardization is lagging behind and the requirements posed are no longer suited for the problems occurring in the end-user's playing field. True, every requirement one changes or poses on product and device developments has an impact of the manufacturing processes chosen, the design effort, the verification

method and all other requirements along the development chain up onto the end-users environment (which can hardly be changed and has to be taken as ultimate end-user requirement).

With System-Efficient ESD Design (SEED, see ESDA White Book 3), the ESD performance of nanoscale devices needs to be complemented by additional protection measures to meet the end-users environment. At the device level, the Human Body Model (HBM) or Charged Device Model (CDM) is used. The Machine Model (MM) has formally been abandoned. The Transmission-Line test Method (ANSI/ESD STM5.5.1-2008, IEC 60749-26TLM), typically 100 ns duration or even very fast Transmission-Line test Method (ANSI/ESD SP5.5.2-2007, vf-TLM), typically less than 10 ns duration, is promoted heavily but no quantitative requirements have been posed similar to the HBM and CDM or end-user levels (IEC 61000-4-2).

Due to further miniaturization and thinner gate and insulation oxides with devices, the ESD requirements posed on these devices have to be reduced accordingly as physical limits w.r.t. peak current densities and peak field strength levels across insulating materials are exceeded into the hot electron effect region. As such, supplementary ESD protection requirements have to apply to the production, manufacturing, handling and assembly area as ESD Protected Area (EPA) requirements have to become tighter by two or more classes: IEC 61340-x-y or ANSI/ESD S20.20.

An integral approach is needed along the entire semiconductor device production chain, from wafer grinding to expose, dicing, bonding, assembly, testing, handling and storage to meet those new ESD protection demands which go beyond the

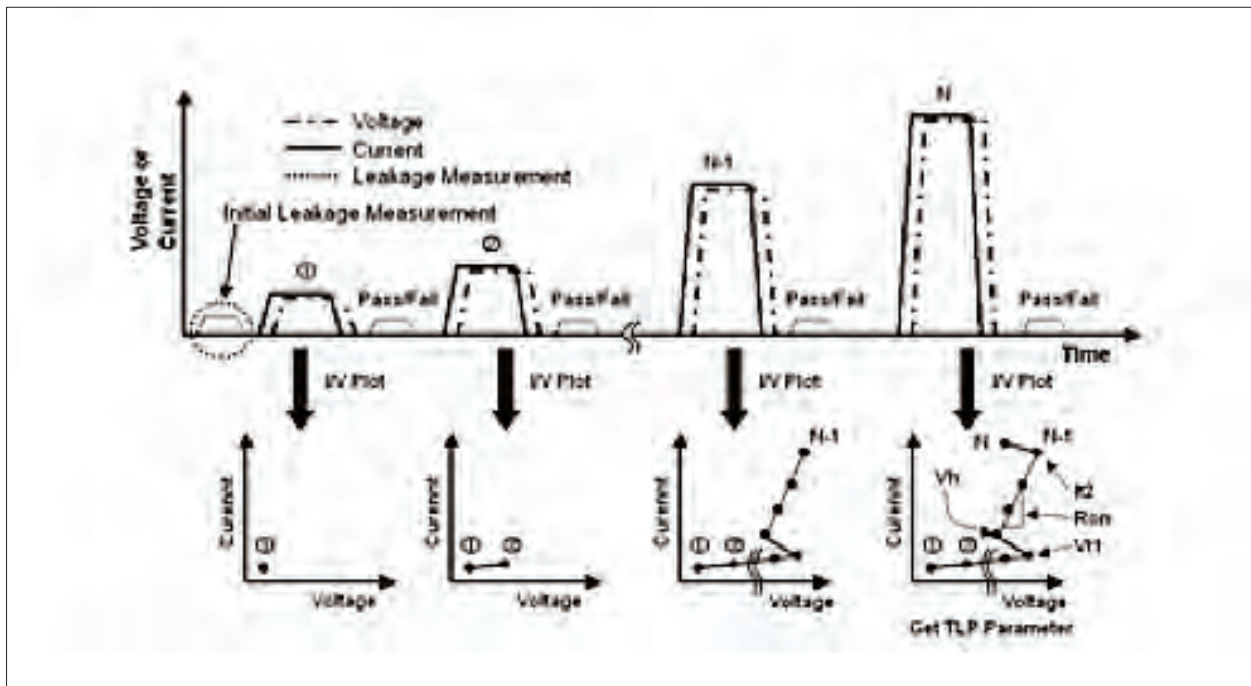

Figure 2: The I / V data after 70% of the TLP test pulse width with increasing voltage.

ANSI/ESD S20.20. To verify these measures along the production chain up until the end-user environment, new requirements and environmental test methods have to be defined and new reference data bases with strong evidence have to be build (and that is where the harvesting (= less defects) can be started).

INTRODUCTION

The ‘old’ ESD test methods for devices stem from the ‘old’ Mil-Std 883 with multi-ns rise-times. The requirements were limited at those days by the measurement bandwidth limitations of oscilloscopes and transient recorders, similar to the ‘old’ product requirements of

the IEC 801-2 (1984). In the meanwhile, the end-user ESD requirements have been updated to the IEC 61000-4-2, 2008, representing the touch with a finger by a standing person. The rise time for end-user ESD pulses are in the sub-nanoseconds range: 0,7 – 1 ns followed by a more energetic lead pulse between 30 – 60 ns after initial touching. Further investigations are ongoing which show that metal-to-metal discharges will only be in the tens of picoseconds rise-time. Device level testing has been upgraded accordingly using the CDM test (dropping charged devices on a metal table), also with sub-nanoseconds rise time and short duration.

TLP testing is introduced (1985) as a Panacea tool which can substitute all other ESD pulses up to the end-user requirements. Typically, the TLP method with some waveform shaping networks could do it but the measurement systems as they are commercially provided to the market typically can’t. In particular the fact that the I/V-points are taken after 70% of the pulse width is a matter of ‘seeding’ concern.

SYSTEM-EFFICIENT ESD DESIGN (SEED)

As defined in the 3rd White Book of the ESDA, the intent is to build an integral ESD protection network in such a way that the ultimate functional circuit is being protected. In principle, this starts at the IC-level where the I/O or supply circuit is protected by the on-chip protection structures. Nowadays, the functional I/O and supply circuits are separately developed by different IP groups and ultimately joined with the pad protection at physical layout.

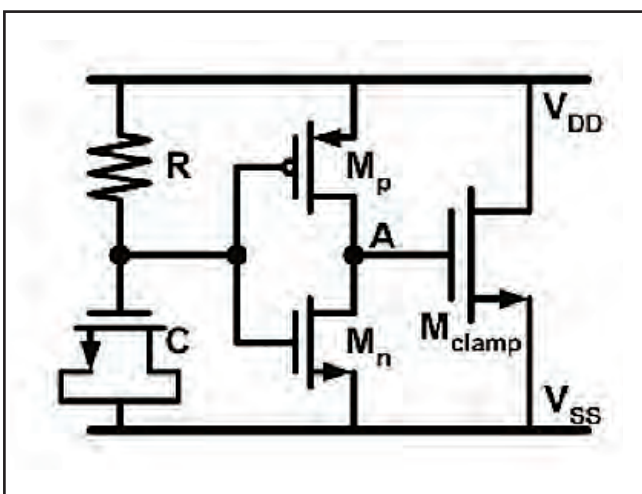

Figure 1: An example of a simplified pulse triggered ESD protection circuit.

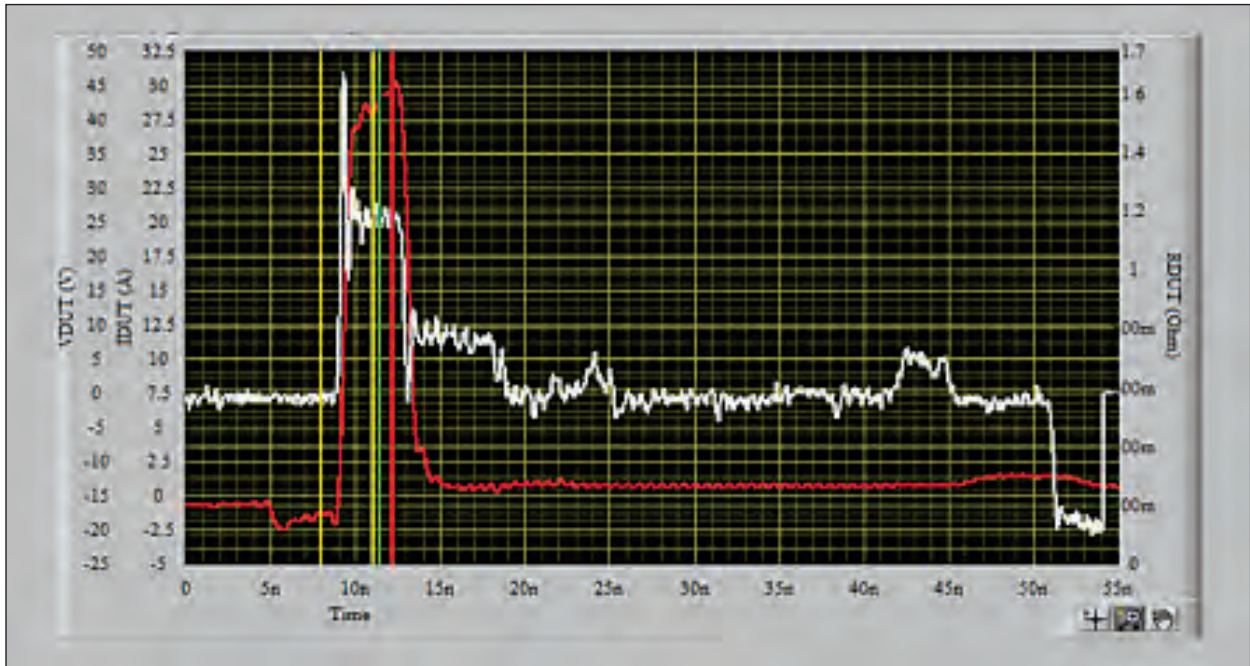

Figure 3: Full TLP I / V response waveform in a single pulse. Please note that the first span with respect to the 70% values.

Most ESD protections are typically dV/dt or threshold/ breakdown voltage triggered, see Figure 1. But what if an only dV/dt triggered ESD protection device is used in parallel to a processor core supply circuitry with large equivalent supply decoupling capacitance? The ESD protection circuitry has been characterized separately before it is added to an IP library without considering further application. By the parallel capacitance of the core the dV/dt at the ESD protection circuit is reduced and as the dV/dt in application has become too dull, that dV/dt triggered protection is no longer effective. As such the discharge current occurring with the ESD event charges up the internal core voltage until an over-voltage occurs.

If an external clamping circuit is used which is clamped to e.g. the +5 volt rail while the internal supply voltage of the circuit to be protected is less, then both protections will formally work as intended, but when used in parallel, the external one will have no function as the first voltage rooftop will be reached by the internal supply. Again true, like a tsunami, the external device will do something, but only when it gets triggered in time at its trigger voltage before the internal clamping circuit takes over.

Taking the clamping voltage data from the internal and external protection devices or circuits doesn't make sense, see Figure 2. Taking the triggering voltage of both devices neither. From both devices, I/V data versus time are required to find out which one takes the burden. As such, taking the I/V data after 70% of the TLP edge doesn't make sense as the whole transition versus time contains the crucial information, see Figure 3. As TLP

systems generate pulses with rise times in the order of 100 ps or even less (≈ 3 GHz bandwidth), the sampling time for the current and voltage data has to be taken even faster considering Nyquist. Furthermore, the two: current and voltage, have to be taken simultaneously with sufficient bandwidth, both for the scope used, as for the sensors, see Figure 4.

As testing by using (vf-)TLP is artificial w.r.t the real ESD phenomena, it is still debatable on whether the data: I/V versus time, found is practically suitable enough to enable SEED prediction. Again, true ... only by having the entire I/V versus time data base will enable a correct input for analogue circuit simulations. Even the inclusion of specific discretized and extracted 3D-layout information of the PCB and IC-packages into this equation is possible.

CDM

The use of the device charging plate with CDM test method which is not RF-wise defined decoupled to the 1 sense resistor reference plane doesn't make sense, see Figure 5. Theoretically, the max. di/dt will be the charged voltage to the device (towards the sense resistor reference plane, not the charging plate) divided by 1 . In reality, by the commercially CDM test systems offered, the di/dt will be immediately limited by the length of the test (pogo) pin used. As a CDM standard update is in progress between ANSI/JEDEC and ESDA, the critical factors for testing i.e. qualification and quantification shall be identified and restrictions to those parameters shall be given. Otherwise the whole CDM test reduces to a unified test method which, as long as everyone is

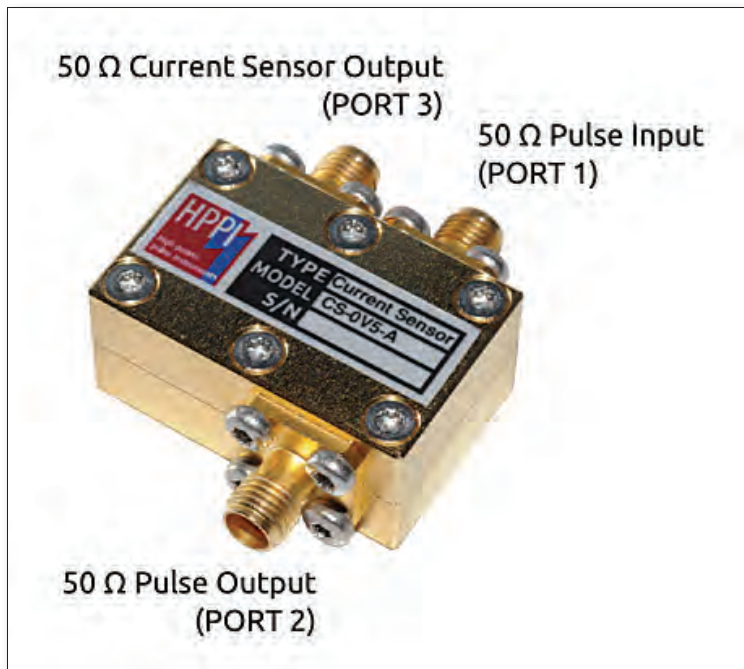

Figure 4: Example of a high bandwidth (<150 ps) current sensor.

making the same mistakes, is providing a common relative reference test method rather than an absolute one.

CONCLUSIONS

Before one can start to harvest SEED, the seeding and breeding has to take place, which will not occur overnight. But to harvest the right SEED parameters, one needs to adapt the way of measurement and characterization first. The ingredients for artificial ESD measurement by the TLP method are there, but the right application to gather the SEED data correctly is lacking.

The SEED approach doesn't only apply between ICs and external protection devices but also between on-chip circuits and the I/O and supply ESD protection circuits. When split grounds are used; VSSA, VSSD, VSSX, etc., also here the SEED approach shall be adopted to guarantee ESD safe operation.

Only dV/dt triggered ESD protection circuits are very likely to fail in combination with their real application.

Reaching SEED carries more constraints in the application than putting the external and on-chip ESD protection circuits in parallel. The signal/supply-ground references taken are crucial w.r.t. the performances

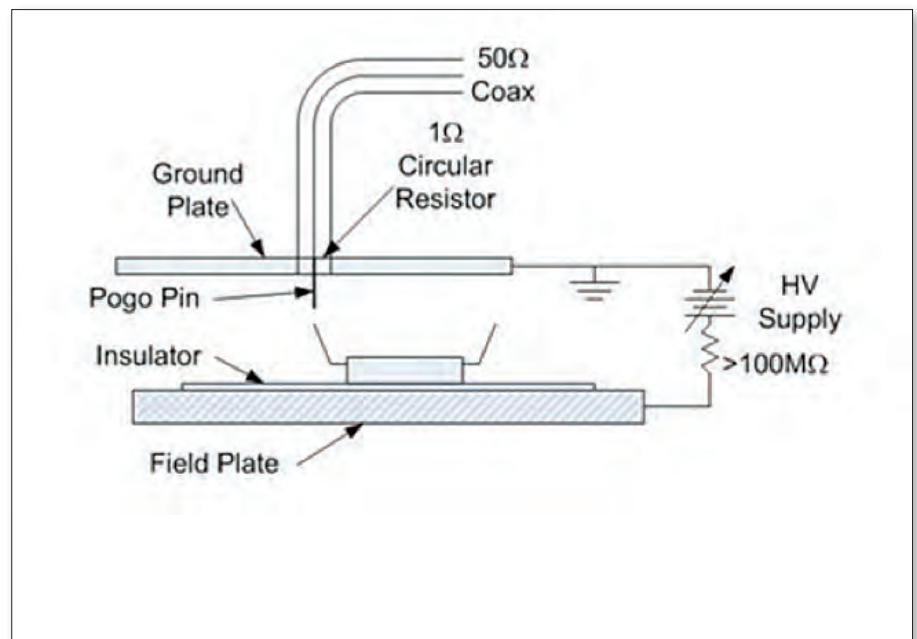

Figure 5: Simplified CDM test setup.

reached

Not only the (vf-)TLP test method needs to be adapted but also the CDM test method requires an update to become a more unambiguous test method rather than a relative test.

The ultimate ESD requirements will be based on the end-user environment which is unlikely to change. As such, the IEC 61000-4-2 or ISO 10605 for an automotive environment have to be adhered.

Characterization of EMI Shielding Gaskets up to 40 GHz

CHRISTIAN BRULL

Schlegel

EMI GASKETS are conductive hardware's designed to conform to joint surface and provide a low impedance path. Compressed between two metal flanges, the gasket presents a complex impedance with resistive, inductive and capacitive properties. This will vary with frequency, materials, compression rate, geometry of the joint, etc. In the meantime, major differences are also observed between different type of gaskets. For instance conductive particle loaded silicones present important variations of efficiency with compression (large variations of electrical liaisons between conductive particles).The surface in contact is the main criteria for Fabric-over-Foam gaskets and for metal gaskets like fingerstocks made of beryllium Copper , variations occur mainly with frequency due to the slot pattern between fingers. As one can predict with all these variable parameters, the characterization of a gasket is rather a challenging exercise.

To understand what measurement techniques are currently available to the gasket industry, reference should be made to IEEE Std 1302 released for the first time in 1998 and revised in 2008 . It is a guidance document which gathers and compares most of the methods available (in 2008) for the characterization of EMI gaskets from DC up to 18 GHz .The document provides a basis for comparing the different techniques in use. It consists of three sections: Full standardized methods, alternative methods derived from standards and alternative non-standardized methods. Every method will not be discussed here (please refer to IEEE Std 1302) but probably the most popular one.

The standard the most commonly used so far is without doubt, Mil DTL 83528 C. This aperture attenuation method derived from the former Mil Std 285

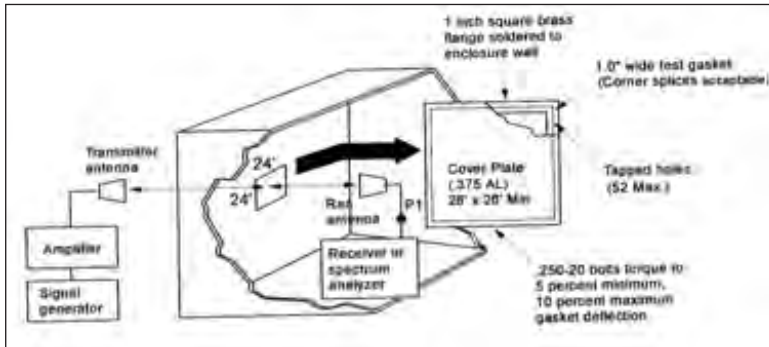

FIGURE 1: Mil-DTL 83528 C test set-up.

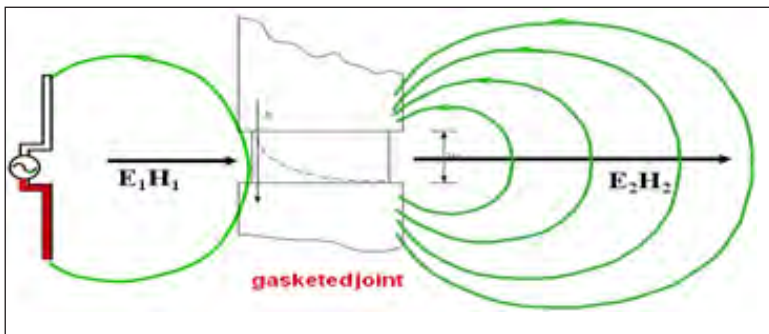

FIGURE 3: Im

(superseded by IEEE 299) characterizes the shielding effectiveness (SE) of the gasket from 20 MHz to 10 GHz (with possible extension to 18 GHz). The test set-up consists of a shielded room with an opening of 610/610 mm (24"/24") with one emitting antenna outside and a receiving antenna inside the room and two meters distance between antennas.

A first measurement is made from one antenna to the other through the opening and a second is made when the opening is closed by means of a metal plate with the gasket to be tested mounted around and compressed. The method measures the field before and after the metal/gasket and the shielding effectiveness of the gasket is: $20 \log E_1/E_2$ (H_1/H_2) or the difference between both measurements in dB from 20 MHz to 10 GHz.

The method has a theoretical repeatability of ± 6 -10 dB. However, repeatability can deteriorate to ± 20 dB with small variations of the antenna position when half the wavelength is getting close to the characteristic dimension of the shielded room (change of antenna in the course of testing for each of the 3 decades). Another issue is the size of gaskets that can be tested by this method. The overlap of the heavy metal plate onto the shielded room wall induces capacitive coupling which affects the measurement when the gasket is small. There are other issues such as the size of the opening and its attenuation, the frequency limitation, the influence of the metallic screws (replaced sometimes by isolated clamps), etc. In practice, absolute values of SE should be taken very cautiously for the various reasons explained. It is observed



FIGURE 2: Mil-DTL 83528 C test set-up.

that offset with actual values obtained in applications, increases with the frequency. The main interest of the method is probably that it is a standard so that measurements according to Mil DTL 83528C can be compared and especially if testing was carried out by an independent Laboratory. The specification requires a minimum of 5 measurements per decade and very often, technical documentation on gaskets provides the average value of the 15 measurements.

The other main standard is SAE ARP 1705, a current injection method measuring transfer impedance. When an Electromagnetic field impinges onto a metal barrier, it induces a current which in turn creates a voltage across the seam which radiates.

In the transfer impedance measuring technique, a current, supposedly resulting from the coupling with an electromagnetic field, is directly injected into the gasketed joint. The voltage across the seam is therefore measured. The ratio voltage over current reported in a 1 meter length defines the transfer impedance of the gasket expressed in dB Ohm/m. The current injection method has a good repeatability of ± 3 -6 dB. SAE ARP 1705 Rev. A is limited to 1.5 GHz and a revision C is in progress which should extend the frequency range to 10 or 18 GHz. The measuring fixture can easily be modified to accommodate modules of different metals so that the degradation of contacts can be studied under different aging conditions. This method provides a direct indication of the conductivity of the gasketed joint but discussions are still ongoing into the relationship between transfer impedance and shielding effectiveness. In the Shelkunoff model, the overall attenuation into a material is the sum of reflection and absorption factors. The reflection factor is actually not considered in the transfer impedance.

For the measurement of Shielding Effectiveness for small size gaskets, TEM-T and Ht Cells method is preferred. This is a non-standardized test method described in IEEE Std 1302 and used in R&D because of its good

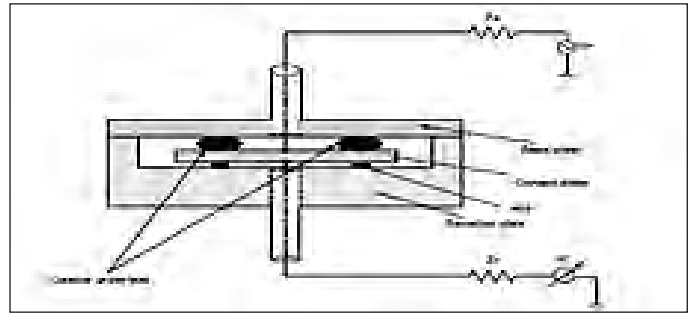

FIGURE 6: TEM-T.

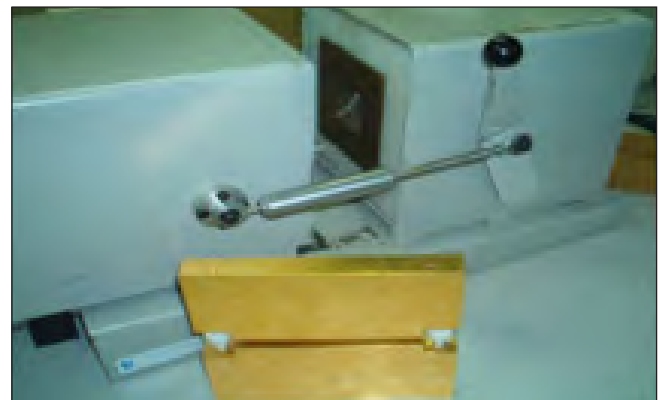

FIGURE 7: Ht.

repeatability (1-3 dB). TEM-t is a TEM mode transmission line device simulating far field conditions. The square coaxial fixture of the TEM-t is cut in the middle so that a gasket holder compressing the gasket under test can be inserted between the two halves of the measuring equipment. The H-t cell is made by a set of two small loop antennas simulating the magnetic near field.

In the following example, the Ht cell was used to evaluate the influence of a small deformation at the bottom (bump) of a Fabric-over-Foam D-shape gasket compared with a standard flat bottom one. The modification is intended to improve the efficiency at low compression in combination with non conductive pressure sensitive adhesive. SE measurement were taken at 0%-10%-20% compression (from the free height of the gasket) . The gasket, SEM's DYNASHEAR EJ9, is 2.3 mm high so that 10 % compression represents a variation of only 0.23 mm in height .The results show that for a flat bottom gasket, a minimum compression of 20 % must be applied to overcome the isolated layer of adhesive while with a small bump at the bottom, substantial SE is already obtained at low compression . H-t cell is an excellent method to characterize SE for such little variations of compression and for such a small size gasket. The absolute SE is not very high but it is mainly due to the short distance between the antenna and the gasket and therefore the low mismatch between the characteristic impedance of

the magnetic field and the intrinsic impedance of the gasketed joint .The frequency range is 100- 500 MHz .

Most Electronic Equipments are working at higher speeds than in the past and with the latest technologies, systems take less and less space. Proximity creates new challenges with more cross-talk between circuits affecting the functions of equipment so that signal integrity has become more challenging, much more than just shielding for the compliance of equipment to a specific standard. In the US, for radiated measurements, FCC (Title 47 part 15.33) requires for systems with the highest frequency over 1GHz , to test to the 5th. harmonic or 40 GHz (whichever is the lowest) .Testing Electronic equipment to 40 GHz starts to be very common in specific fields of Electronics . As one can see ,there is a major gap between standards available to the gasket industry and the market requirements. For that reason a technical committee started to work on the revision and the extension of the IEEE Std 1302 from 18 GHz to 40 GHz. At the time of writing, there are not too many works in progress for the characterization of EMI gaskets up to 40 GHz . The major one is the stripline method.

Schlegel Electronic Materials, in partnership with Prof. J.Catrysse and Prof. D.Pissoort of the KULab REMI research group of the KULeuven (University of Leuven-Belgium), developed a new testing fixture to

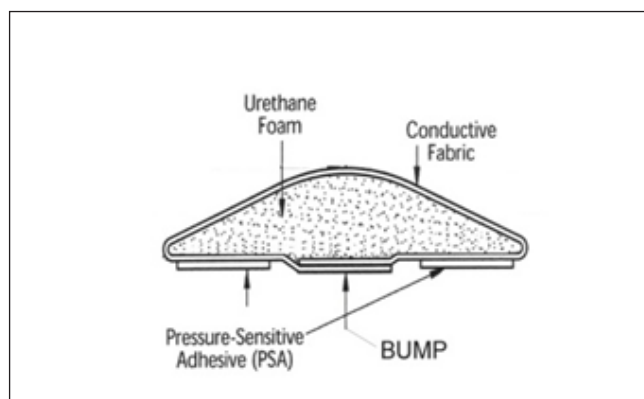
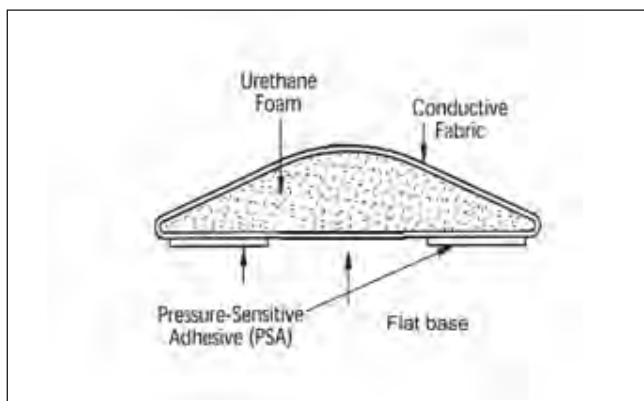
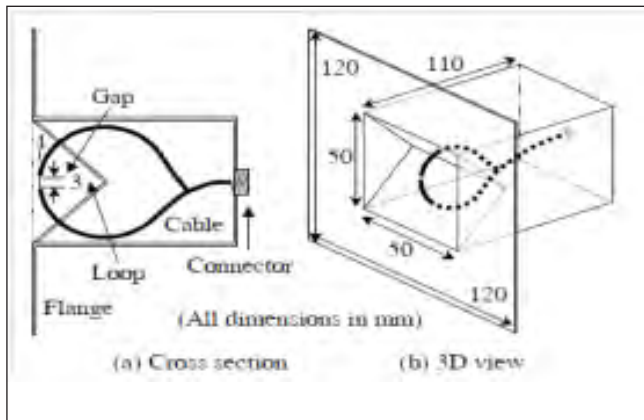
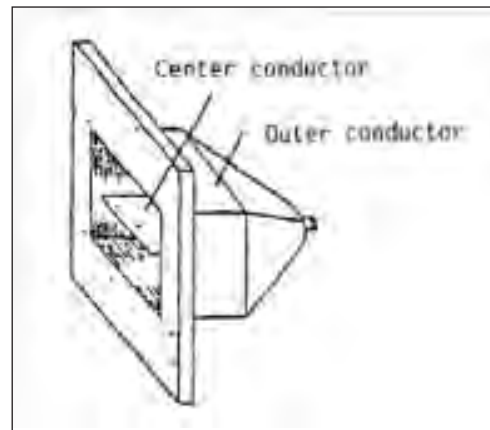
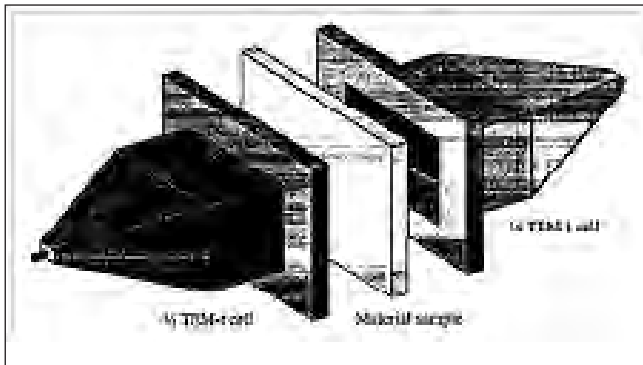

characterize the Shielding effectiveness of conductive gaskets up to 40 GHz. The principle of this fixture is based on a method that was first introduced by Prof. B. Koerber to measure the radiated emission and susceptibility of Integrated Circuits (IEC 61967-8 and IEC 62132-8). The method utilizes a stripline antenna which closes over a PC-Board.

In the new stripline fixture, the PC board with the IC under test is replaced by a small microstrip antenna embedded into a cavity within the ground plane. The cavity can be closed by means of a thick plate which compresses the gasket under test. A stripline antenna covers the set-up.

The testing procedure, similar to IEEE 299 or Mil DTL 83528 C, is as follows:

- 1) a direct measurement from microstrip to stripline to establish a reference (measurement of the signal before the shield)
- 2) measurement of the closed cavity with the gasket under test (measurement of the signal after the shield)
- 3) Difference between both measurements in dB is the Shielding Effectiveness of the gasket.

Repeatability is excellent even if the signals are noisy. We can see on the hereafter graphs the SE obtained from 1 to 40 GHz for one fabric-over-foam gasket 3 by 9 mm, and one metal fingerstock D-shape of same dimension but with a slot of 0.45 mm and a finger width of 4.32 mm. Both were compressed to 50% from free height. The fabric-over-Foam gasket has a pretty steady response while the metal gasket displays a continuous drop from 12 GHz because of the slot between the fingers. The attenuation will vary as a function of the slot pattern and the stripline fixture is an interesting mean to figure out its impact on SE at high frequency.

Another example is the SE measurement of an I/O connector gasket made of conductive fabric over a non conductive foam core. The gasket is fabricated to the required width and then die-cut according to the dimensions of the connector shell. This type of solution worked fine in the past when most of the issues were in the 300 MHz region. The stripline method shows that this solution works up to 1 GHz. In fact with the frequency increase, openings created with the die-cut of non conductive foam core are leaking and sometimes the impedance of the return current path between flanges may even create antenna effect. The stripline method shows that by using a conductive fabric over a Z conductive foam core, large improvements are obtained. At low frequency the fabric brings the major contribution and as the frequency rises, the Z conductive foam core

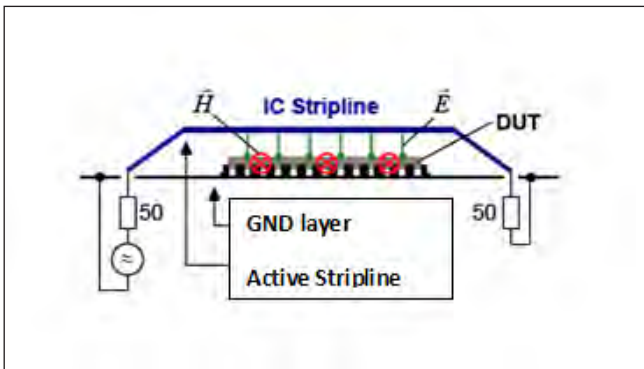
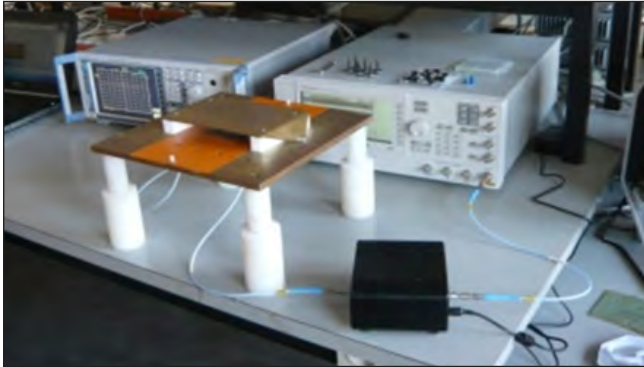
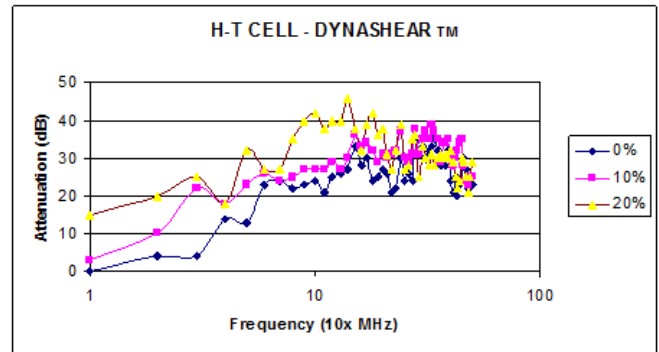
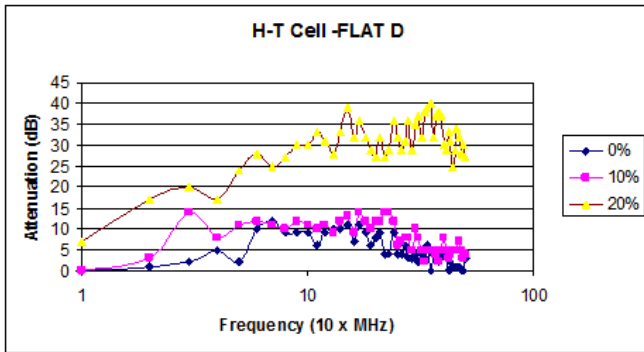

ensures a higher shielding and a shorter return current path making this gasket construction a broadband solution (SEM Ref. ORS-II).

The stripline method features some other interesting characteristics. The microstrip antenna being a trace on a board, the PC board environment is reproduced so that the data obtained can be expected in a similar environment. For that reason, the method may be considered in the future for the characterization of PC-board shielded cans .

The test method will be soon supported by a standard from SAE (Society of Automotive and Aerospace Engineers) under the reference SAE ARP 6248 .

AUTHOR BIO

Christian Brull has an Engineering degree in Electronics –HELMO Liege -Belgium. Brull started his EMC work in 1989 in application engineering and research and development in the field of EMI shielding. He is secretary of the IEEE PE 1302/ working group for the revision and the extension to 40 GHz of the IEEE Std 1302 (Guide for the characterization of conductive gaskets in the frequency range of DC to 18 GHz. Member of the Society of Automotive and Aerospace Engineers SAE,AE-4/EMC Committee. Currently he is Global Product Manager for Schlegel Electronic Materials

REFERENCES

- IEEE Std 1302 –Rev. 2008 : IEEE Guide for the Electromagnetic Characterization of Conductive Gaskets in the Frequency Range of DC to 18 GHz
- J. Catrysse, F. Vanhee, D. Pissoort, C. Brull, and G. Vandebosch, “A new stripline measuring setup for the characterisation of conductive gaskets up to 18 GHz”, Proceedings of the IEEE International Conference on Electromagnetic Compatibility, Fort Lauderdale, Florida, USA, July 2010,
- J. Catrysse, F. Vanhee, D. Pissoort, C. Brull, and P. Reynaert, “Expanding the Stripline Measuring Set-up for the Characterisation of Conductive Gaskets up to 40 GHz”, Proceedings of the IEEE International Conference on Electromagnetic Compatibility, Pittsburgh, Pennsylvania, USA, Aug. 2012
- J.Catrysse, T.Grenson, F.Vanhee, D.Pissoort and C. Brull, “The importance of continuous and homogeneous Gasket Conductivity up to 40 GHz”, Proceedings of EMC Europe 2013 Brugge Symposium, Brugge, Sept. 2013
- Schelkunoff, S. A., Electromagnetic Waves. New York: Van Nostrand, 1943.

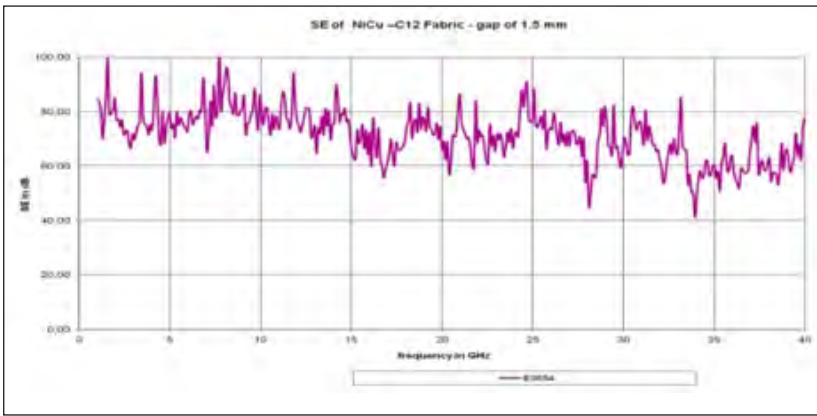

FIGURE 17: Fabric over foam.

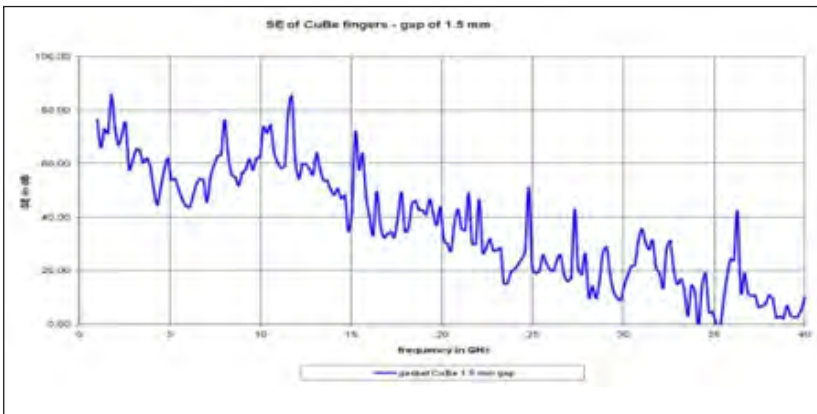

FIGURE 18: BeCu Fingerstocks.

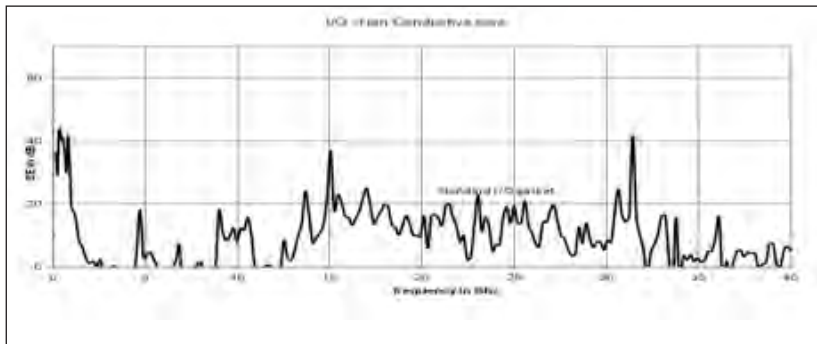

FIGURE 19: Fabric over non conductive core.

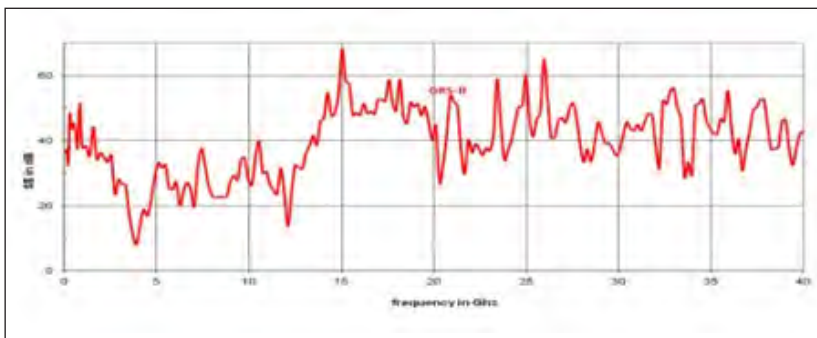

FIGURE 20: Fabric over Z conductive core.



FIGURE 21: μ -strip.



FIGURE 22: Stripline.



FIGURE 23: Metal plate attached to test



STAY IN TOUCH
WITH THE WORLD
OF EMI/EMC NEWS

WEEKLY NEWSLETTER
SUBSCRIBE TODAY

interference^{ITEM™}
THE INTERNATIONAL JOURNAL OF
ELECTROMAGNETIC COMPATIBILITY | **technology**

interferencetechnology.com

WORLD FIRST

REALTIME HANDHELD SPECTRUM ANALYZER



1Hz – 20,1GHz

40GHz Power Meter

Cable Radar

Oscilloscope (16dB dynamic)

OCXO

USB- I/Q- Streaming

Patent Pending

SPECTRAN 5
REALTIME Spectrum Analyzer

MADE IN GERMANY

AARONIA AG
WWW.AARONIA.DE

Aaronia AG, Gewerbegebiet Aaronia AG, D-54597 Strickscheid, Germany
Phone ++49(0)6556-93033 : Fax ++49(0)6556-93034 : Email: mail@aaronia.de