

NEW

Presented by
interference
technology

2016 REAL TIME SPECTRUM ANALYZERS

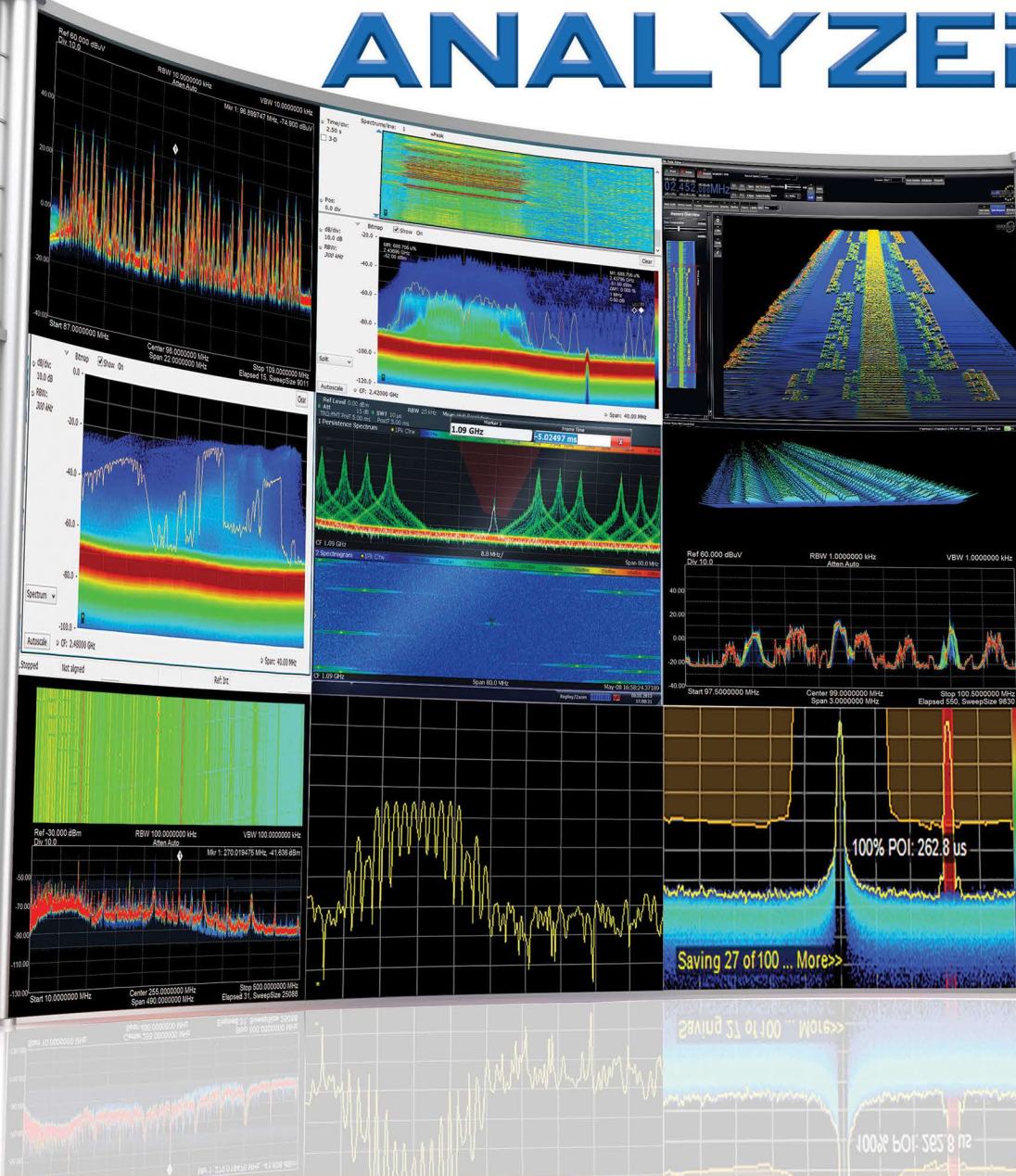

Mini Guide Series

AARONIA REAL-TIME ANALYZER

Integrated 40 GHz Oscilloscope // 6 GHz Vector & I/Q Generator // 10ns Pulse-Detection...

SPECTRAN V5 SERIES

1 Hz to 20 GHz

175 MHz
RTBW

Rugged Outdoor



175 MHz REAL-TIME Bandwidth

POI < 1 μ s / 10ns Pulse-Detection

40 GHz Power Meter / Oscilloscope

USB I/Q Streaming

Inclusive Remote Software

Unlimited FULL RTBW Recording

MORE FORM FACTORS COMING SOON!

Gewerbegebiet Aaronia AG, D-54597 Strickscheid
Telefon: +49(0)6556-93033 Fax: +49(0)6556-93034
www.aaronia.de E-Mail: mail@aaronia.de

**AARONIA AG**
WWW.AARONIA.DE

MADE IN GERMANY

Go wide.
Go deep.



Take your design farther with better views of elusive signals. With integrated 1 GHz analysis bandwidth, 510 MHz real-time analysis and impressive phase noise, the UXA delivers the wide open performance and deeper views you need to troubleshoot hidden design problems up to 50 GHz. Easily link cause and effect. Connect to the UXA and deliver your next breakthrough.

Keysight UXA Signal Analyzer, N9040B

1 GHz integrated analysis bandwidth

>75 dBc spurious-free dynamic range

-136 dBc/Hz phase noise at 1 GHz, 10 kHz offset

14.1" streamlined, multi-touch UI

Deepen your knowledge.
View demo video and app note at
www.keysight.com/find/widebandUXA

USA: 800 829 4444 CAN: 877 894 4414

© Keysight Technologies, Inc. 2016



Unlocking Measurement Insights

Agilent's Electronic Measurement Group is now **Keysight Technologies**.



CONTENTS

Types	7
Export Controls	9
Definitions	11
Advantages of Swept versus Real-Time Spectrum Analyzers	13
Applications	15
Product Comparison Chart	19
Instrumentation Guide	21
References	41

SPONSORED FEATURES

Low-Cost Modular USB-Based Real-Time Analyzers	31
Sponsored Feature: A Portable Handheld Real-Time Analyzer	39

ADVERTISERS

Aaronia	INSIDE FRONT COVER, 20, 22, 29, 30, 32, 38, 40
EDICON USA 2016	6
EMC LIVE	28
Keysight	1, 20, 25, 29
Rohde & Schwarz	10, 20, 26, 29



REAL-TIME SPECTRUM ANALYZER MINI GUIDE



KENNETH WYATT
Senior Technical Editor,
Interference Technology

INTRODUCTION

Welcome to this new on-line “mini guide” series from *Interference Technology*! This first issue is devoted to real-time spectrum analysis.

The spectrum analyzer is the one “go-to” tool for every RF, microwave, and EMC/EMI engineer. In recent years, a new acquisition technology has developed, based on FFT capture and digital signal processing – the real-time (RT) spectrum analyzer. This new mini guide from *Interference Technology* will review the basics of conventional swept versus real-time spectrum analyzers and highlight some of the recent advances and instrument form-factors. We’ll continue on with a comparison of current products and key specifications, available from several manufacturers, and then describe a number of applications of real-time analysis, along with sample screen captures.

CALL FOR PAPERS



2016
Electronic Design
Innovation Conference
Workshops & Exhibition

September 20-22

Hynes Convention Center

Boston, MA

www.EDICONUSA.com

EDI CON USA is a new and unique event experience that brings the RF/microwave, EMC/EMI and high-speed digital design communities together to address the engineering and manufacturing issues that face today's design engineers.

Conference Topics

- RF, Microwave & High-Speed Digital Design
- Measurement & Modeling
- Systems Engineering
- 5G Technologies
- EMC/EMI
- IoT Design
- Radar/Communications

Conference Sponsor

Raytheon

Organized By



Submit your paper online at
www.ediconusa.com/papers2016
by April 15, 2016



TYPES

There are three primary types of spectrum analyzer systems; (1) the classic swept-tuned analyzer, (2) the hybrid FFT analyzer, and (3) the real-time analyzer. There's a rather blurred distinction between these last two analyzer topologies, as we'll discuss below.

1. SWEPT-TUNED ANALYZER

This classic topology measures power versus frequency and is based on a superhetrodyne principle. The input spectrum is fed to a low-noise mixer and down-converted via a swept local oscillator (LO) to a baseband intermediate frequency (IF). The input frequency spectrum is filtered by a band pass filter. This then gets detected and mapped using the appropriate (actual) input spectrum frequency limits (span). The bandwidth of the band-pass filter dictates the resolution bandwidth (RBW) of the measurement. Better frequency resolution equates to longer sweep times, depending on the frequency span selected. Typically, there will be “dead time” (similar to Figure 1) between trace sweeps, where T1, T2, etc., are the sweep times and CALC1, CALC2, etc., are the times taken up by the time between sweeps.

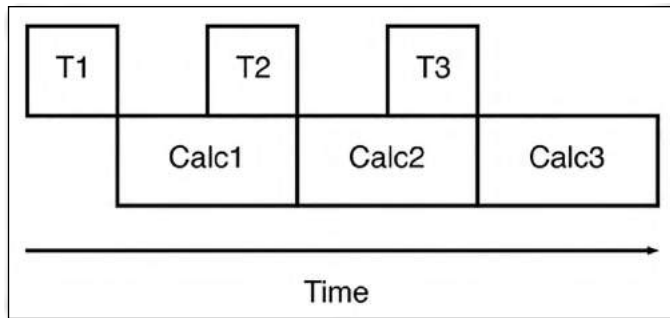

Figure 1 – When the calculation time exceeds the time record window, the analyzer is not operating in real time and there will be dead time, due to the gaps between time records.

2. HYBRID FFT ANALYZER

The hybrid FFT-based analyzer uses much the same input topology as the swept-tuned analyzer, but digitizes the intermediate frequency (IF) from the mixer using a fast Fourier transform of the input signals. A benefit is the use of digital filtering and associated improved filter shape factors and settling time. Typically, the analyzer will capture the spectral data, then digitize and perform calculations, then display the results. Because of the processing time, there may be a gap (or dead time) between capturing and displaying the spectral data (Figure 1). However, with today’s technological advances in A/D converters and FFT processing, there’s little difference any more between the Hybrid FFT analyzer and real-time analyzer. Both are now using the same basic topology with a fixed LO, which is stepped if the span is wider than the FFT window.

3. REAL-TIME ANALYZER

A real-time analyzer uses a stationary LO, looks at narrow windows of bandwidth (real-time bandwidth), and digitizes the incoming spectrum. This digitized spectrum is stored in a time record buffer (T1, T2, etc.) and held for processing by the FFT algorithm. Ideally, once digitized, FPGAs process FFTs at a rate equal, or faster, than the collection rate (Figure 2 and 3). However, this collection rate depends on the span and resolution bandwidth. The major difference between the hybrid FFT analyzer and real-time analyzer is the sheer number-crunching ability of the real-time calculation, as well as a fast graphics processor, which allows for a data-dense display of various frequency-versus-time presentations and digital demodulation.

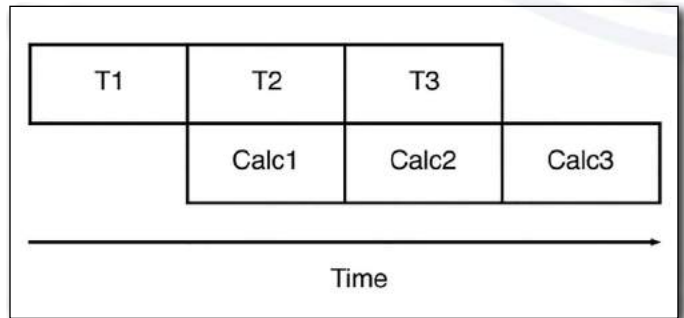

Figure 2 – So long as the calculation time is less or equal to the time record acquisition time, the analyzer is capturing data in real time.

Real-time analyzers often use a stepped LO/FFT approach to cover wide spans. For example, a span setting of several GHz would require the LO be stepped multiple times in order to cover the desired frequency range. In such a mode, the RTSA would have dead time spots similar to the swept analyzer.

If the FFT calculation takes longer than the time required to fill the time record buffer the data collection must stop and there will be a gap (or dead time) between capturing and displaying the spectral data. When the FFT calculation is finished, the time record can be transferred to the FFT and collection of another time record begun. Because some input data were missed, the analyzer is no longer operating in real time.

The time record will vary with the span of the analyzer. For wide frequency spans, the time record is shorter, allowing less time for the FFT calculation. The frequency span or bandwidth setting where the FFT computation time and time record are equal is the real-time bandwidth (RTBW) of the analyzer. The RTBW for the analyzers in this review range from 27 to 500 MHz.

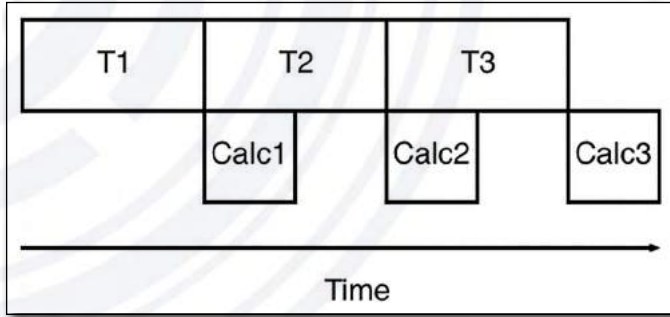

Figure 3 – With improved DSP calculations, the time records for spectrum acquisitions are continuous.

Faster analog-to-digital converters (ADCs) allow a wider analysis bandwidth. But, as digital signal processing (DSP) has improved the real-time bandwidth has widened out from several MHz to several hundred MHz. Some advanced analyzers use multiple ADCs and overlapping FFT windows, as well as parallel processing to capture the input spectrum without gaps during the normal dead time (Figure 4). The processing is very fast and can typically catch an intermittent pulse of as little as 1 μ s in duration.

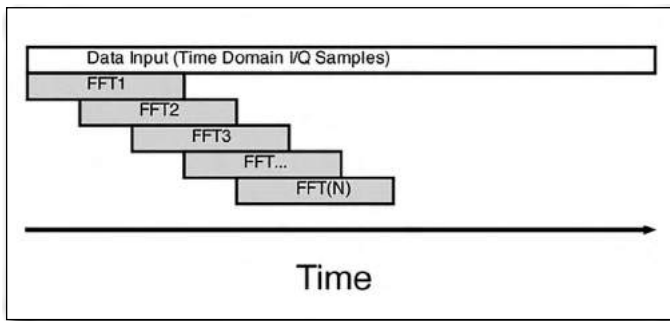

Figure 4 – Multiple A/D converters and overlapping FFT windows allows continuous spectrum and very narrow pulse capture.

For a more in-depth treatment of spectrum measurements, I recommend Reference 1.

EXPORT CONTROLS

The U.S. government limits the export of some technologies through the Department of Commerce's Bureau of Industry and Security. The Export Administration Regulations (EAR), Commerce Control List, Supplement No. 1 to Part 774 specifies that "signal analyzers with both frequency mask trigger and 100% probability of trigger (capture) for signals having a duration of 15 μ s, or less", would require export control. Some analyzers avoid this commerce control by either offering frequency mask triggering **or** 100% probability of intercept. For more information, the web site is: <https://www.bis.doc.gov>.



Catch them because you can. With the new flagship in EMI testing.

The new R&S®ESW EMI test receiver catches them all, the spikes and other disturbances that may show up in your DUT. Thanks to its unrivalled dynamic range, its ultrafast FFT-based time domain scan and realtime spectrum analysis, there is no way to escape its analysis power. For certification or lab tasks – this is the instrument you can totally rely on.

Get the details: www.rohde-schwarz.com/ad/esw





DEFINITIONS

There are several terms that are important when evaluating real-time spectrum analyzers. Some of these terms include; (1) Probability of Intercept (POI) and the related Minimum Detection Time, (2) Density and Persistence, (3) Spectrogram, and (4) Decimation. These terms are defined below.

1. PROBABILITY OF INTERCEPT (POI) OR MINIMUM DETECTION TIME

Users want to know, “What is the shortest duration of an event (or pulse) that I can dependably observe?” This is a quantity best expressed as a unit of time. In simple terms, the actual attainable minimum detectable value depends on factors such as sample rate (frequency span), window function, trigger level, noise level and the maximum amplitude of the signal of interest. The difference between analyzer noise level and input signal amplitude is the key determining factor: the greater the offset, the shorter the minimum detectable duration; the lower the offset (especially less than 20 dB), the greater the likelihood of noise interfering with the measurement. For a more in-depth treatment of this, refer to Reference 2.

This is the minimum pulsed signal the real-time analyzer can detect. For example (Reference 3) describes a sample calculation:

“Example: for an analyser with 40 MHz of realtime bandwidth (the maximum RF span that can be processed in realtime) approximately 50 Msample/second (complex) are needed. If the spectrum analyzer produces 250 000 FFT/s an FFT calculation is produced every 4 μs. For a 1024 point FFT a full spectrum is produced 1024 x (1/50 x 106), approximately every 20 μs. This also gives us our overlap rate of 80% (20 μs – 4 μs) / 20 μs = 80%.”

2. DENSITY AND PERSISTENCE

The advantage of real time analyzers is that they can show a lot of data on the display, including very fast moving or intermittent signals. By increasing the density (or intensity) of the plot, the difference between infrequent and steady signals may be visualized easily. By varying the persistence, brief signals will show up longer on the display and then gradually disappear. The better analyzers allow a variable persistence. In addition, different signal levels can be mapped to different colors forming a multi-color display of spectral activity.

3. SPECTROGRAM

A spectrogram (or waterfall) display shows how the RF spectrum varies with time (Figure 5). The spectrogram display shows all three dimensions of frequency, signal level, and time. The color of the spectrogram indicates the signal level with red normally indicating a higher level and blue indicating a lower level. Using the spectrogram, it's easy to visualize intermittent and dynamic behavior of signals. The better analyzers allow a user-adjustable time line, from fast to slow. This record may also be recorded on some analyzers for future playback.

4. DECIMATION

The Nyquist theorem states that for baseband signals you only need to sample at a rate equal to twice the highest frequency of interest. For band pass signals you just need to sample at a rate at least twice the bandwidth. The sample rate can be reduced when the needed bandwidth is less than the maximum. Sample rate reduction, or decimation, can be used to balance bandwidth, processing time, record length and memory usage.

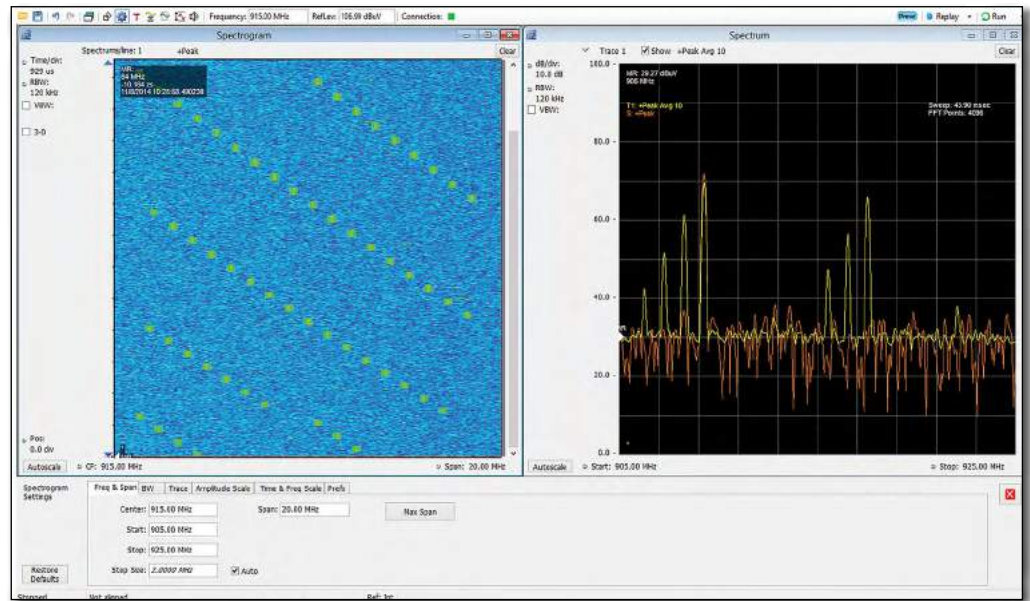

Figure 5 – A sample spectrogram (left panel) from a Tektronix RSA306 USB-powered analyzer showing the transmitted signal from a 900 MHz frequency-hopping radio. Time is the vertical axis with the earliest time capture at the bottom. As the display slowly scrolls upward, each frequency hop may be seen as a small green rectangle, gradually stepping in frequency (horizontal axis). The corresponding frequency versus amplitude plot is in the right-hand panel. Because of persistence mode, the signal peaks slowly recede downward.



ADVANTAGES OF SWEPT VERSUS REAL-TIME SPECTRUM ANALYZERS

Sweped spectrum analyzers are simpler and less costly than their digital FFT counterparts. However, they can only display a spectrum one sweep at a time. There will be dead time between sweeps, so it's very possible they will miss or inaccurately capture fast-moving or brief pulsed signals, such as digitally-modulated or spread-spectrum signals like Wi-Fi, Bluetooth, or a multitude of digital modulations.

This problem of dead time is somewhat alleviated by using the "Max Hold" feature on most analyzers, where multiple sweeps are captured and "built-up" to reveal the envelope of the fast-moving or intermittent signals.

Real-time analyzers, on the other hand, have little, or no, dead time between FFT captures, so are optimized to capture very fast moving or intermittent signals. This makes them ideal for capturing and displaying today's digital communications systems, such as wireless and mobile systems. They are also ideal for spectrum surveillance, with many of the high-end analyzer able to record and play back historical spectrum captures – even demodulating the signals at a later time. This assumes, however, that the frequency spectrum being monitored is no wider than the real-time bandwidth of the analyzer.

A distinct advantage with swept analyzers is their ability to sweep a broad range of frequencies while maintaining a narrow frequency resolution. For example, they can sweep from near zero to 10 GHz with a resolution bandwidth of 1 kHz in a single sweep and not miss any steady signals. An FFT-based analyzer would have to step the LO and make multiple measurements to piece together the same 10 GHz span, with the resulting dead time in between frequency bands. This may actually take longer than sweeping...it depends. However, for most current FFT analyzers, the narrower the RBW the more the speed advantage of FFT because it simultaneously calculates all the measurement points within the FFT analysis BW. Therefore, the smaller the RBW the faster the speed advantage of FFT.

Another big advantage of real-time analyzers is the fact that the persistence mode can display multiple signals on the same frequency or band channel. For example, multiple Wi-Fi signals on a single channel may be observed and analyzed.

In addition, features like spectrogram (waterfall) displays, showing spectral captures versus time, are very useful for identifying interference or EMI issues. Many have Frequency Mask Triggering (FMT), where a mask is generated around a signal or portion of spectrum of interest. If an intermittent signal penetrates the mask, the data is instantly captured and recorded. This allows post-capture analysis of recorded interference or intermittent EMI.

Finally, the "I/Q" baseband data may be used to display digitally modulated data streams as constellation plots or demodulated digital data versus time. AM, FM, and phase-

modulated signals may also be demodulated and analyzed. Power measurements, such as spectral power density (SPD) may also be calculated in both the frequency and time domains. Most of the higher-end analyzers are really vector signal analyzers (VSA), which preserve the amplitude and phase information. This information may be displayed any number of ways, allowing analysis of high-speed digital data, including error vector magnitude (EVM), a rating of digital modulation.

BENEFITS OF SWEPT ANALYZERS

- Generally lower cost
- Good phase noise and minimal spurs and usually superior dynamic range
- Able to sweep a broad range of frequencies while keeping good frequency resolution
- Recent technologies have reduced the physical size
- Some are battery portable
- Familiar user interface and controls
- Some test standards continue to specify swept measurements

BENEFITS OF REAL-TIME ANALYZERS

- Very fast capture rate
- Fast "data-dense" displays (density, persistence, spectrogram)
- Able to capture fast-moving or intermittent signals with 100% POI
- Able to display multiple signals within the same frequency channel
- Spectrum-based frequency-mask triggering
- Can view elusive or dynamic signal behavior
- Can demodulate and analyze digital data





APPLICATIONS

There are a number of interesting applications for real-time spectrum analyzers, primarily when measuring brief events or digital modulations. These include (1) pulse measurements, (2) evaluating radar, (3) VCO and PLL analysis, (4) RFID transponders, (5) spectrum management and surveillance, (6) radio communication and wireless, and (7) EMI analysis. We'll be discussing these applications in the section below.

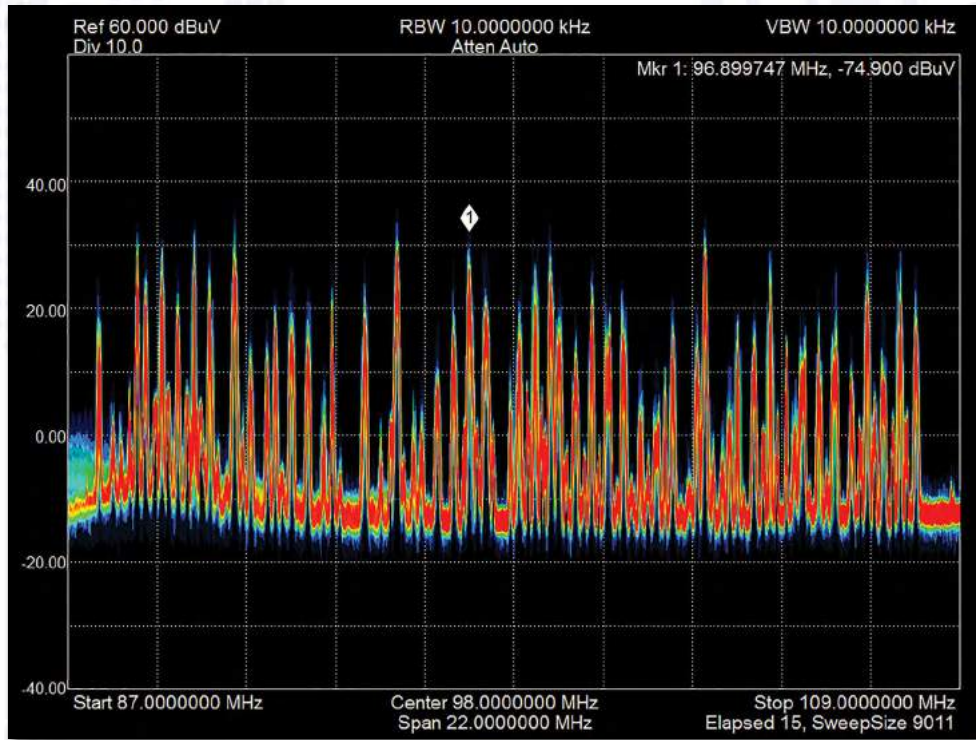

Figure 6 – The U.S. FM broadcast band showing stations from 87 to 108 MHz. Depending on the size of the metropolitan area, coverage area, and propagation conditions, it's highly likely that two, or more stations may interfere with each other in the fringe areas of coverage. This is the whole basis of spectrum management.

1. PULSE MEASUREMENTS

Pulse information for carrier frequency, rise and fall times, occupied spectrum, and pulse width are some of the many measurements that may be performed. Examples might include pulse repetition frequency (PRF), duty cycle, and pulse-to-pulse phase information.

2. RADAR

Analyzing pulse measurements in both the time and frequency domain simplifies radar testing and characterization. Things like spurs, noise Figure, and spectrum occupancy are easily measured. The persistence mode can also reveal interference issues with the radar system.

3. VCO/PLL ANALYSIS

Voltage-controlled oscillators or phase-locked loop ICs can often produce random, sweeping, or glitch behavior that would not be detected by normal swept analyzers. Real-time analyzers can capture this frequency versus time (and even temperature) behavior in order to optimize circuit designs.

4. RFID

Things like radio frequency identification (RFID), near-field communication (NFC), tire pressure-monitoring systems (TPMS) systems may all be monitored and analyzed using real-time analyzers. These systems operate from 135 kHz to 2.4 GHz and in both active and passive modes. Many of these systems operate in the Industrial, Scientific, and Medical (ISM) bands and are thus susceptible to other interfering signals, which may easily be identified using real-time analysis.

5. SPECTRUM MANAGEMENT AND SURVEILLANCE

Detection of intermittent signals in the presence of other signals is near impossible with swept analyzers. For example, real-time analyzers can easily differentiate different Wi-Fi access points using the same channel or a short impulsive signal amidst several others. This is one area where real-time analyzers really shine. Keep in mind this assumes the spectrum being monitored is no wider than the real-time bandwidth. Using frequency mask triggers helps capture any intermittent signals with near-100% probability. Recording of spectrum usage for later playback and analysis is important for both surveillance and spectrum management (Figure 6).

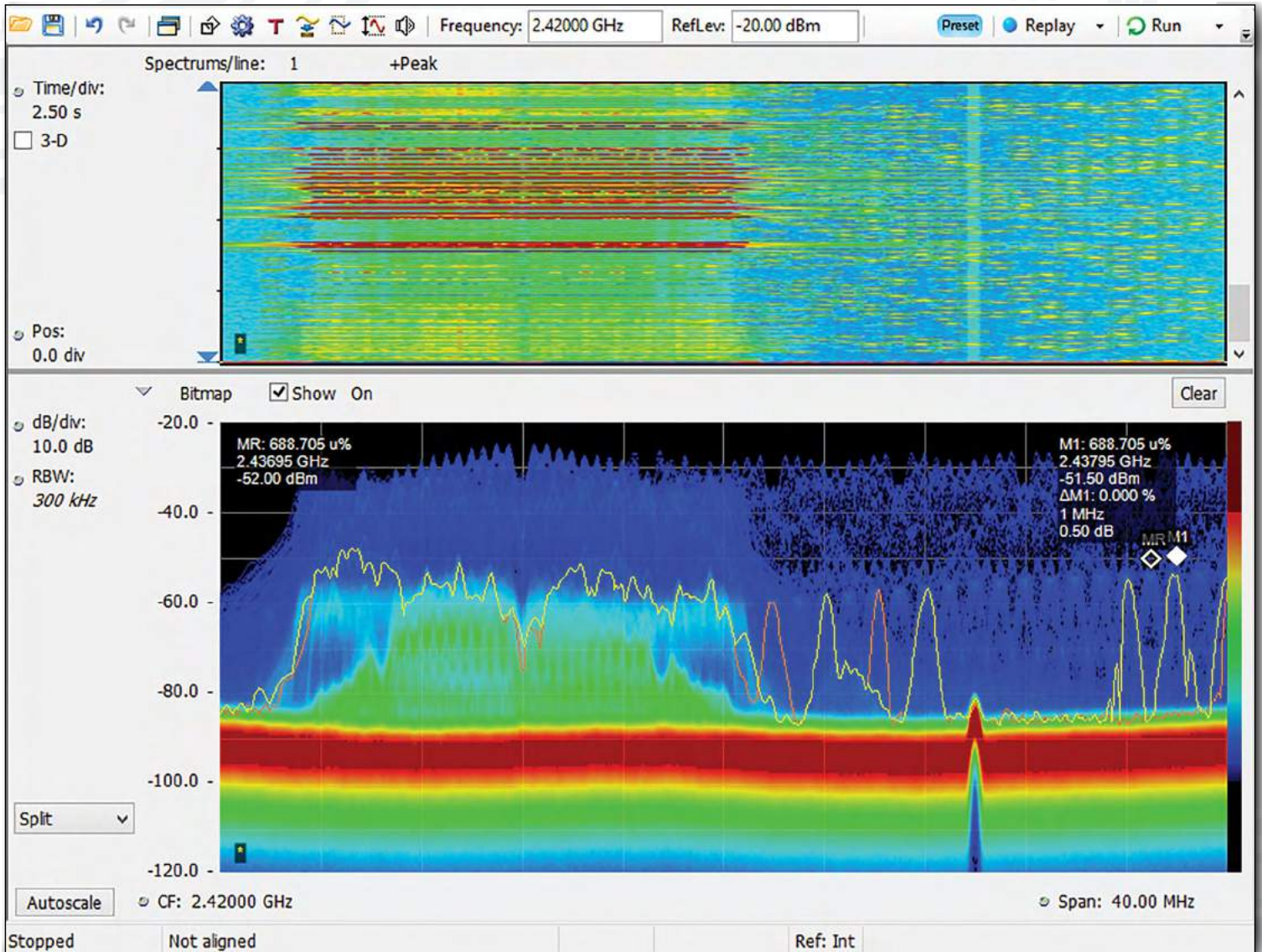

Figure 7 – The 2.4 GHz ISM band is displayed using a Tektronix RSA306 USB-controlled analyzer. Multiple Wi-Fi signals on adjacent (and the same) channels, as well as Bluetooth frequency-hopping signals, may be observed. As more wireless devices are used within a given area, the chances of collisions occur more frequently, with resulting slowdown of data transmission.

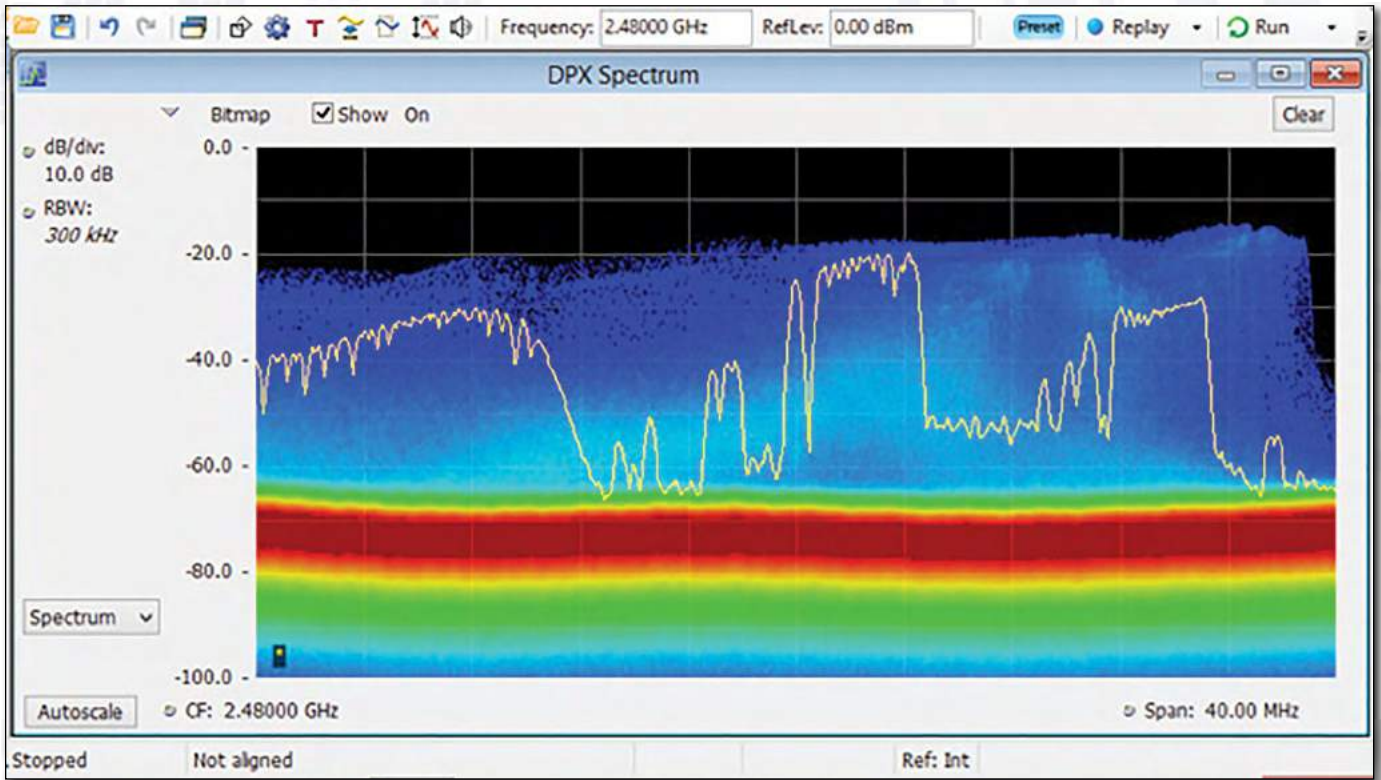

Figure 8 – Again, looking at the 2.4 GHz ISM band, we see a microwave oven sweeping through much of the band. This would completely jam a Wi-Fi signal in the near vicinity. The pulses captured are periods when the magnetron is turning on and off in sync with the power line frequency.

6. RADIO COMMUNICATIONS AND WIRELESS

Most of today's radio communications systems are now digitally controlled with remote or automatically adjustable frequency and power. In addition, with the proliferation of mobile products and "Internet of Things" (IoT) expanding exponentially, the probability of interference – especially in the license-free ISM bands – will only increase. Real-time spectrum analyzers will more likely become the tool of choice in resolving these potential interference or coexistence issues (Figure 7). In addition, real-time analyzers would be ideal as a basis for mobile direction-finding (DFing) interference sources to commercial broadcast or communications systems (Reference 4).

7. ELECTROMAGNETIC INTERFERENCE (EMI)

For the same reasons above as well as the growing complexity within both military and commercial products, the chances of one device interfering with another device or communications system is

also on the increase (Figure 8). In addition, clock rates and edge speeds are ever increasing and test failures are on the increase. Troubleshooting with a real-time analyzer makes short work of intermittent or complex EMI problems. Fortunately, EMI standards bodies are gradually incorporating the newer-technology FFT-based spectrum analyzers as options for compliance measurements. One distinct advantage of real-time analyzers, when used for compliance testing, is that they can capture harmonic signals within the required spectrum range very quickly, saving test time, as well as capture complex frequency versus time analysis.

SUMMARY

While real-time spectrum analyzers are more expensive, they are generally the better choice for capturing fast moving, dynamic, or very narrow impulsive signals, as well as analyzing and displaying digital modulations clearly. Just be aware of their limitations when looking across a span greater than their real-time bandwidth. Thanks to low cost components, there are real-time solutions to fit most any budget and performance level.



PRODUCT COMPARISON CHART

2016 REAL TIME SPECTRUM ANALYZER MINI GUIDE

Manf/Model	Lower Freq	Upper Freq (GHz)	RT Bandwidth (MHz)	100% POI	Price (\$, £)
Aaronia					
HF-8060/80120 V5	9kHz	6, 12, 16, 20	40, 80/175 (opt)	<1us / 10ns Pulse	3,998-9,998
HF-8060/80120 V5 5.25PC	9kHz	6, 12, 16, 20	40, 80/175 (opt)	<1us / 10ns Pulse	3,498-9,498
HF-8060/80120 V5 ODB	9kHz	6, 12, 16, 20	40, 80/175 (opt)	<1us / 10ns Pulse	5,998-11,998
HF-8060/80120 V5 OEM	9kHz	6, 12, 16, 20	40, 80/175 (opt)	<1us / 10ns Pulse	3,498-9,498
HF-8060/80120 V5 RSA	9kHz	6, 12, 16, 20	40, 80/175 (opt)	<1us / 10ns Pulse	5,498-11,498
HF-8060/80120 V5 X	9kHz	6, 12, 16, 20	40, 80/175 (opt)	<1us / 10ns Pulse	3,498-9,498
Spectran XFR V5 PRO	1Hz	20	80/175 (opt)	<1us / 10ns Pulse	25,000
Berkeley Nucleonics					
RTSA-7500-8B	100kHz	8	10	1.02us	3,950
RTSA-7500-8	100kHz	8	100	1.02us	6,150
RTSA-7500-18	100kHz	18	100	1.02us	9,910
RTSA-7500-27	100kHz	27	100	1.02us	13,465
Gauss Instruments					
TDEMI M/M+ series	10Hz	1, 3, 6	162.5	<300ps	25,000
TDEMI G series	10Hz	1 to 40	162.5	<300ps	40,000
TDEMI X	10Hz	1 to 40	325/645	<300ps	50,000
Keysight					
N9020A-RT1 MXA	10Hz	3.6 to 26.5	85, 160	17.3us	59,571
N9020A-RT2 MXA	10Hz	3.6 to 26.5	85, 160	3.57us	62,733
N9020B-RT1 MXA	10Hz	3.6 to 26.5	85, 160	17.3us	59,571
N9020B-RT2 MXA	10Hz	3.6 to 26.5	85, 160	3.57us	62,733
N9030A-RT1 PXA	3Hz	3.6 to 50	85, 160	17.3us	88,008
N9030A-RT2 PXA	3Hz	3.6 to 50	85, 160	3.57us	92,201
N9030B-RT1 PXA	3Hz	3.6 to 50	85, 160, 509.47	17.3us	88,088
N9030B-RT2 PXA	3Hz	3.6 to 50	85, 160, 509.47	3.57us	92,201
N9038A-RT1 MXE	3Hz	3.6 to 44	40/85	3.71us	83,500
N9040B-RT1 UXA	3Hz	3.6 to 50	255, 509.47	17.17us	130,613
N9040B-RT2 UXA	3Hz	3.6 to 50	255, 509.47	3.51us	136,553
Rohde & Schwarz					
ESR3-B50/K55 opt	9KHZ	3.6	40	24us to 82ms	86,000
ESR7-B50/K55 opt	9KHZ	7	40	24us to 82ms	53,000
ESR26-B50/K55 opt	9KHZ	26.5	40	24us to 82ms	111,000
ESW	2Hz	8 to 44	80	15us	86,000
FSVR	10Hz	7 to 40	40	12.5us	50,000
Signal Hound					
BB60C	9kHz	6	27	1us	2,879
Tektronix					
RSA306	9kHz	6.2	40	100us	3,490
RSA5103B	1Hz	3	25, 40, 80, 125, 165	.434us	25,400
RSA5106B	1Hz	6.2	25, 40, 80, 125, 165	.434us	34,900
RSA5115B	1Hz	15	25, 40, 80, 125, 165	.434us	43,900
RSA5126B	1Hz	26.5	25, 40, 80, 125, 165	.434us	49,900

Table 1 – This table lists all the known real-time spectrum analyzers currently available. The base analyzer model is listed, along with optional frequency limits and other specifications. The prices listed are for the base models with minimum frequency range and minimum real-time bandwidth and are listed in Euros or USD (about equivalent at today's exchange rate). Additional options are extra. Some specifications, such as 100% ROI, are dependent on several factors and are difficult to compare between manufacturers, due to the varying instrument setups and assumptions made. The specifications listed were gleaned as best I could from the manufacturers data sheets. Specifications not listed were not found in the data sheets or were not reported in time for publication. I'd encourage readers to contact the manufacturers for any clarification in specifications or pricing.



INSTRUMENTATION GUIDE

AARONIA AG



Figure 9 – Aaronia sells this ruggedized military version of the Spectran V5 real-time analyzer with a 1 Hz to 20 GHz frequency range. It is billed as a counter-surveillance receiver with integrated GPS receiver and can scan 20 GHz in less than 20 ms. Real time bandwidth is up to 175 MHz, depending on the model and whether you order the increased bandwidth option. There is up to 8TB fast SSD recording storage. Applications would include technical surveillance countermeasures (TSCM), security surveys and eavesdropping detection, interference hunting, radio monitoring and enforcement, EMC/EMI testing, and spectrum management. Base price is \$25,000. Image courtesy Aaronia AG.

BERKELEY NUCLEONICS



Figure 10 – Berkeley Nucleonics recently introduced a small Ethernet-controllable analyzer with 100 MHz real-time bandwidth. Being controlled via Ethernet allows operation remotely from the controlling PC. In addition, multiple analyzers may be controlled by the same PC and synced together to gain higher real-time bandwidths – a unique feature not available on competing models. Frequency ranges start at 100 kHz and go to 8/18/27 GHz. Prices range from \$3,950 to 13,465, depending on the model. Image courtesy Berkeley Nucleonics.

GAUSS INSTRUMENTS GMBH



Figure 11 – Gauss Instruments was one of the pioneers of the real-time FFT analyzer. They currently have three model series that start at 10 Hz and go up to 1/3/6/26.5/40 GHz (depending on model). The real-time bandwidths are 162.5 MHz and 325 (645 MHz option) for the “X” series. Base prices range from \$25,000 to \$50,000. Image courtesy Gauss Instruments GmbH.

KEYSIGHT TECHNOLOGIES



Figure 12 – Keysight Technologies sells several models in the N90n0A- and new B-series, with the N9038A model specifically designed for EMI measurements. Shown above is the new style N9030B PXA analyzer. Frequency ranges from 3/10/20 Hz to 3.6/8.4/13.6/26.5/43/44/50 GHz (depending on the model). Real-time bandwidth ranges from 40 to 509.47 MHz depending on the model. Base prices range from \$59,571 to \$136,553. Image courtesy Keysight Technologies.

ROHDE & SCHWARZ



Figure 13 – Rohde & Schwarz offers their new ESW EMI test receiver with 80 MHz real-time capture (shown in the figure) with touchscreen control, and includes models that cover 2 Hz to 8/26/44 GHz. All models include a very fast FFT-based time domain scan, which can be run with two CISPR detectors to record parallel measurements. In addition, the new ESW includes special notch filters for the 2.4 and 5.6 GHz ISM bands, to help prevent signal overload when making sensitive measurements outside, but near, these bands. Other models include the FSVR and ESR3/7/26 that can range in frequency from 9 kHz (10 Hz option on FSVR) to 3.6/7/26.5 GHz. Real-time bandwidths are 40 MHz for all models. Base prices range from \$50,000 to \$77,000. Image courtesy Rohde & Schwarz.

TEKTRONIX

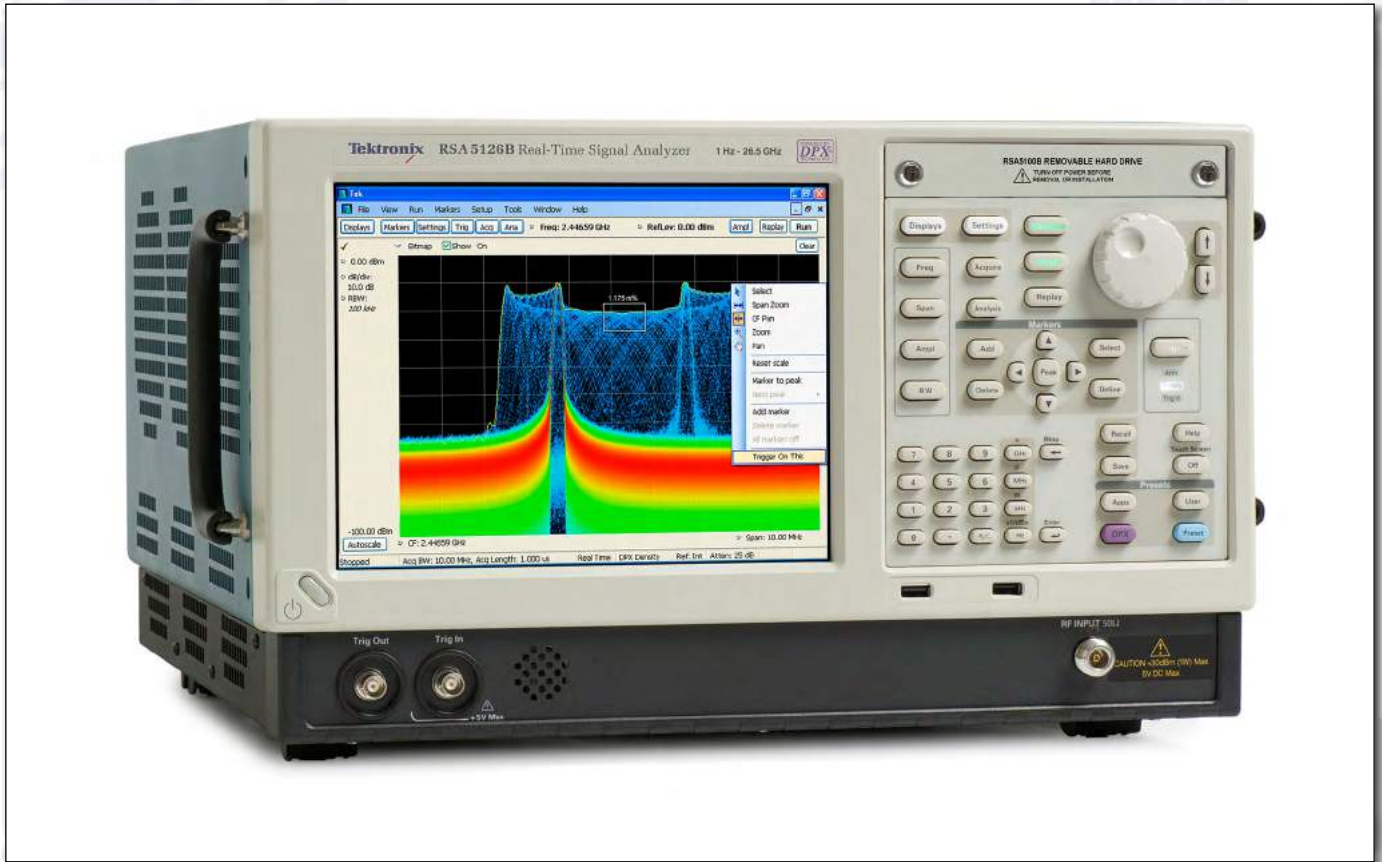

Figure 14 – The Tektronix RSA-5126B analyzer (shown in the figure), plus others in the RSA5100-series tune from 1 Hz to 3/6/15/26 GHz (depending on the model). Real-time bandwidths range from 25/40/80/125/165 MHz (depending on the option). Prices on this series range from \$25,400 to \$49,900. They also offer their RSA306 USB-controlled real-time analyzer that tunes from 9 kHz to 6 GHz (see sidebar). Image courtesy Tektronix.

3500 ATTENDEES
20 SPEAKERS
15 SESSIONS
**1 AMAZING ONLINE
CONFERENCE**

EMC LIVE[®] 2016

APRIL 26-28
2 0 1 6

Join industry leaders as they share and discuss the latest in EMI/EMC technology. 3 days of practical, important and useful EMC information for electronics engineers.

And it's free.

Sign up **today** to receive updates

www.emclive2016.com



MANUFACTURERS

Most of these manufacturers will have several good references, application notes and videos on real-time spectrum analysis on their web sites.

- Aaronia <http://www.aaronia.com>
- Berkeley Nucleonics <http://www.berkeleynucleonics.com/products/real-time-spectrum-analyzer-7500.html>
- Gauss Instruments <http://www.gauss-instruments.com/en/products/tdemi>
- Keysight Technologies <http://www.keysight.com/en/pc-2278039/real-time-spectrum-analyzer-rtsa?cc=US&lc=eng>
- Rohde & Schwarz https://www.rohde-schwarz.com/en/product/fsvr-productstartpage_63493-11047.html
- Signal Hound <https://signalhound.com/products/bb60c/>
- Tektronix <http://www.tek.com/spectrum-analyzer>

WORLD'S FASTEST REAL-TIME SPECTRUM ANALYZER SOFTWARE „RTSA-SUITE“

- Gapless REAL-TIME 3D View, no Flicker, up to 25 Million Samples/sec
- Unlimited Recording-Time, Streams & Records without any Time Limitation
- Low Hardware requirement, works on Intel Atom (i5 recommended)
- Superfast 3D LIVE Display
- Remote Interface
- REAL-TIME Demodulation
- Smart REAL-TIME 3D Trigger
- Graphic Cards GPU Support
- Multi Device Support
- Use either USB 2.0 or 3.0
- Game Changer in Hard- and Software with up to 175 MHz RTBW

WATCH

YouTube

our Demo Videos!

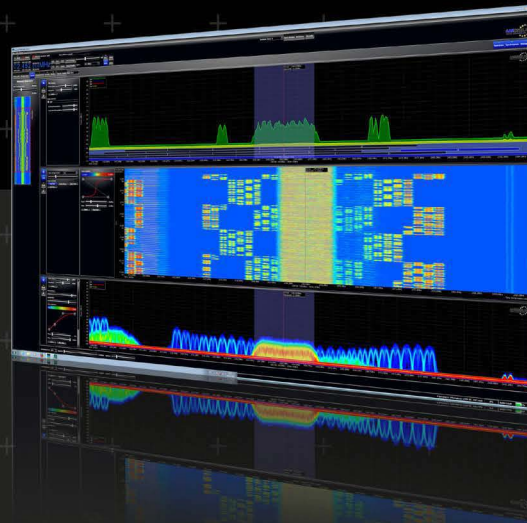
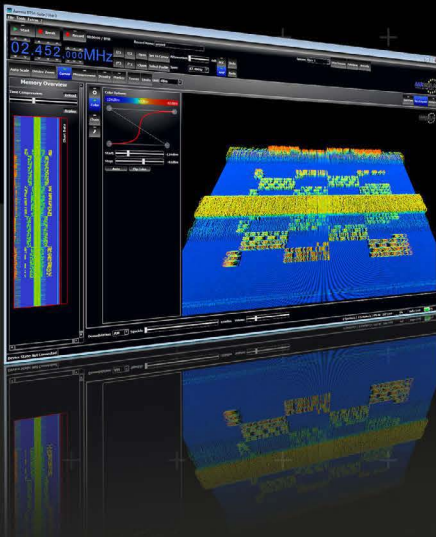
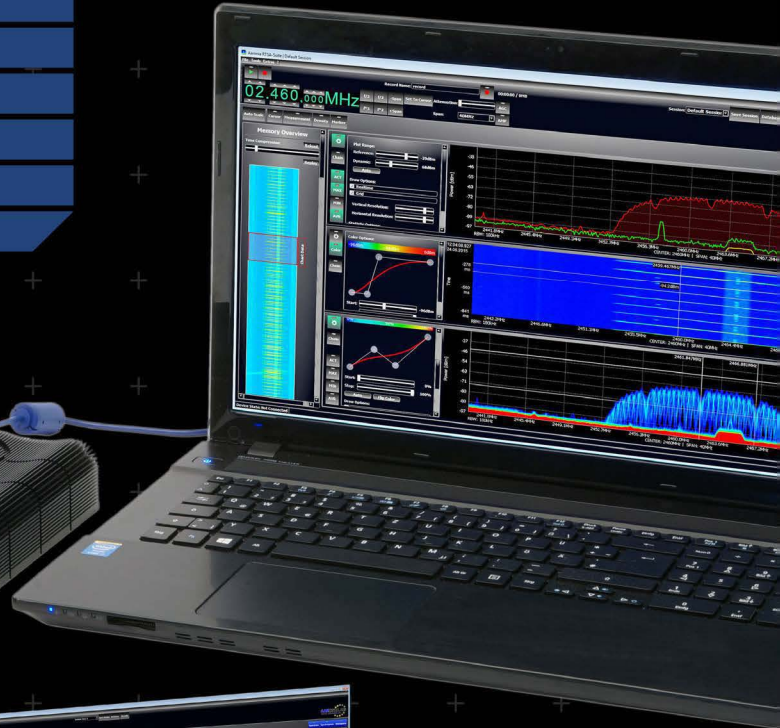

FREE DEMO

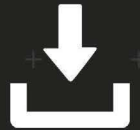

DOWNLOAD



Gewerbegebiet Aaronia AG, D-54597 Strickscheid
Telefon: +49(0)6556-93033 Fax: +49(0)6556-93034
www.aaronia.de E-Mail: mail@aaronia.de

AARONIA AG
WWW.AARONIA.DE

MADE IN GERMANY



LOW-COST MODULAR USB-BASED REAL-TIME ANALYZERS



Figure 15 – The Signal Hound BB60C USB-controlled real-time spectrum analyzer, shown with supplied accessory. The unit is small enough to be Velcro'd to the lid of a laptop.

Recent technology advances in mobile communications has now supplied the test and measurement industry with small, custom, application-specific components and ICs that allow miniaturization of conventional bench top instruments.

Companies such as Signal Hound, Tektronix, Berkeley Nucleonics, Aaronia, and others, have jumped at the chance to produce small USB-powered (or Ethernet-controlled) modules that have very advanced measurement capability at unheard of price points. I'd like to feature two of these – the Signal Hound BB60C and Tektronix RSA306.

Signal Hound introduced their model BB60C real-time analyzer module a couple years ago that is designed to work with a high-performance PC laptop or desktop computer under the Win-

dows OS (Figure 15). The analyzer covers 9 kHz to 6 GHz and has a 27 MHz real-time bandwidth with +10 to -158 dynamic range. The architecture uses 50% overlapping FFT windows for a 100% POI down to as low as 1.6 μ s pulses. The price is just \$2,879.

The analyzer can display near instant frequency information in up to a 27 MHz instantaneous bandwidth (IBW) with an amazing 24 GHz/sec sweep speed with 1.2 million FFTs/sec. The response is so quick, it can trap and display intermittent signals with pulse width as narrow as 4 μ s, with 1.6 μ s pulses only attenuated by 2-3 dB. The I/Q data stream is sent through the USB 3.0 port and data streams between 250 kHz to 27 MHz of amplitude-corrected bandwidth may be viewed. The software also includes the ability to measure EVM, constellation diagrams, symbol tables, and bit pattern recognition for various PSK and QAM modulation formats. It can display the spectrogram (waterfall) in either 2D or 3D as shown in Figure 16.

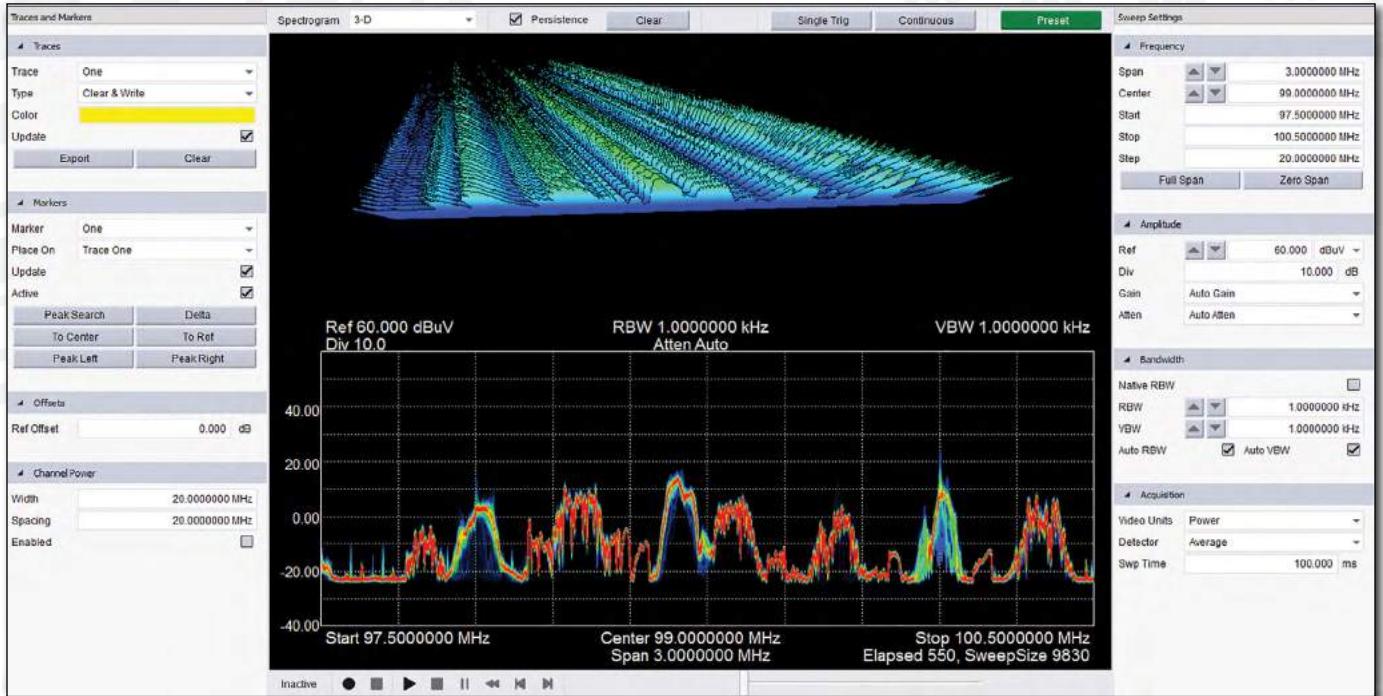

Figure 16 – The user interface for the Signal Hound BB60C is showing the FM broadcast band with a scrolling 3D spectrogram display. The user controls are well designed and easy to control.

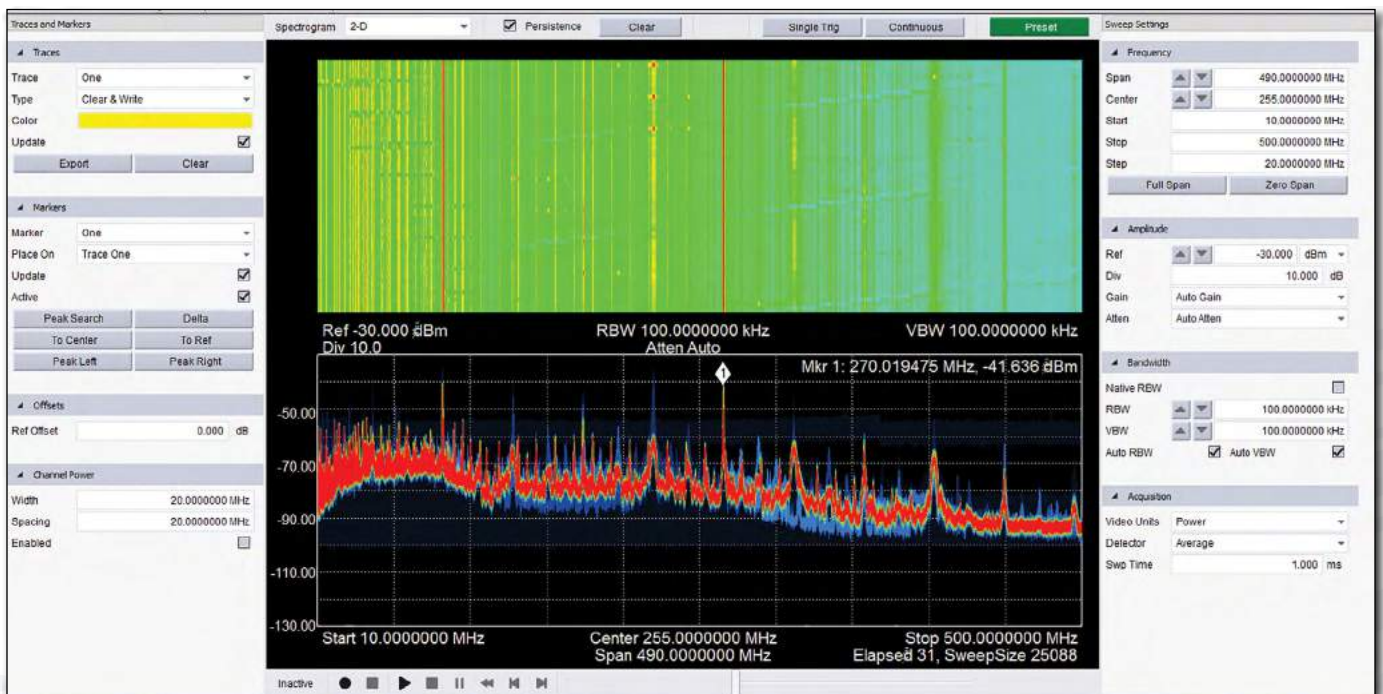

Figure 17 – One more example of the Signal Hound display showing some product harmonics using an H-field probe, along with a 2D spectrogram of the frequency versus time. Notice that one of the harmonics is pulsing (red dots towards the center of the spectrogram).

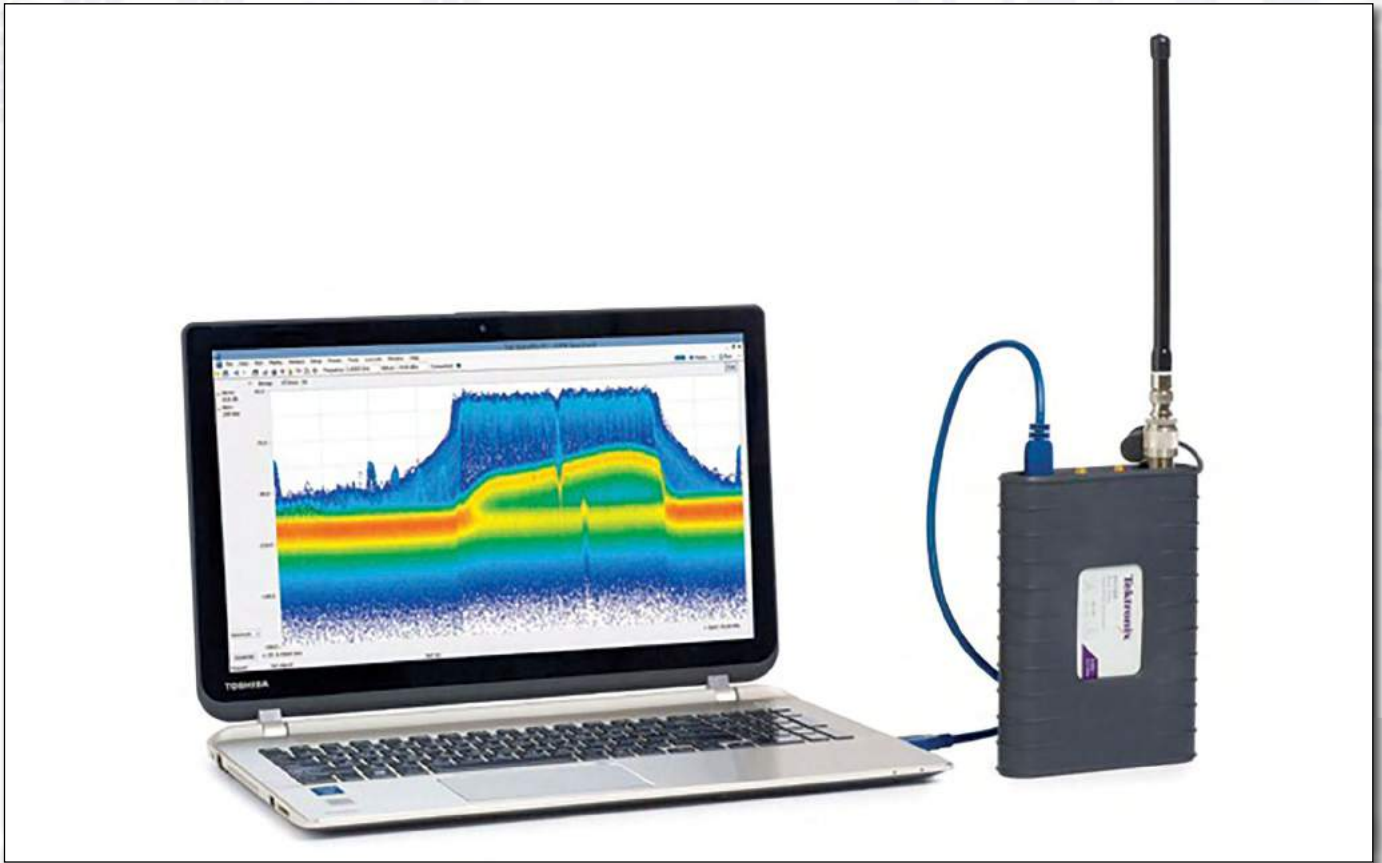

Figure 18 – The Tektronix RSA306 USB-controlled real-time spectrum analyzer, shown with supplied PC-Vu software. Image courtesy Tektronix.

Because much of the signal processing is performed within the PC, you'll need a pretty powerful computer. In fact, the minimum recommended setup would be a PC running Windows 7 or 8, with an Intel i7 with a quad core processor, 8 GB RAM, one USB 3.0 port and one adjacent USB 2.0 or 3.0 port, and OpenGL 3.0 capable graphics processor. Most high-end PC laptops should work well.

ARCHITECTURE

The BB60C analyzer is based upon a two-stage superheterodyne receiver. Two independent IF frequencies (1.26 and 2.42 GHz) are used based on the tuned RF frequency. Distributed element notch filters are used to suppress spurious responses. To reduce second-order intermodulation, push-pull amplifiers are used to cancel even-order mixing. Direct conversion is used below 10 MHz to avoid mixing products. The front end uses a preamp-attenuator combination that has a spurious-free

dynamic range better than 50 dB. The 14-bit ADC uses built-in dithering, which adds improved linearity as well as decreased spurious IF responses. ADC spurs are typically less than 70 dB below the carrier. From the ADC, the digitized IF data goes to an FPGA, where it's packetized and sent over a USB 3.0 port to the PC, where 80 million 14-bit ADC samples per second are processed into a spectrum sweep or I/Q data stream.

If portability is an issue and you have a powerful enough laptop, this may be just the ticket to affordable EMI pre-compliance testing or troubleshooting. The user interface is clearly laid out and the controls worked just as you would expect of most bench top analyzers (Figure 17). I'm often on the road visiting clients and toting around a 6 GHz analyzer in my briefcase sounds pretty good.

Tektronix also introduced their model RSA306 USB-powered modular real-time analyzer about March 2014 (Figure 18). It also requires a high-performance PC using the Windows OS. It should be noted that the supplied SignalVu-PC software will allow basic spectral measurements with lower-performance PCs, but for the more intensive measurements, like spectrograms and digital signal analysis, the faster PCs are required.

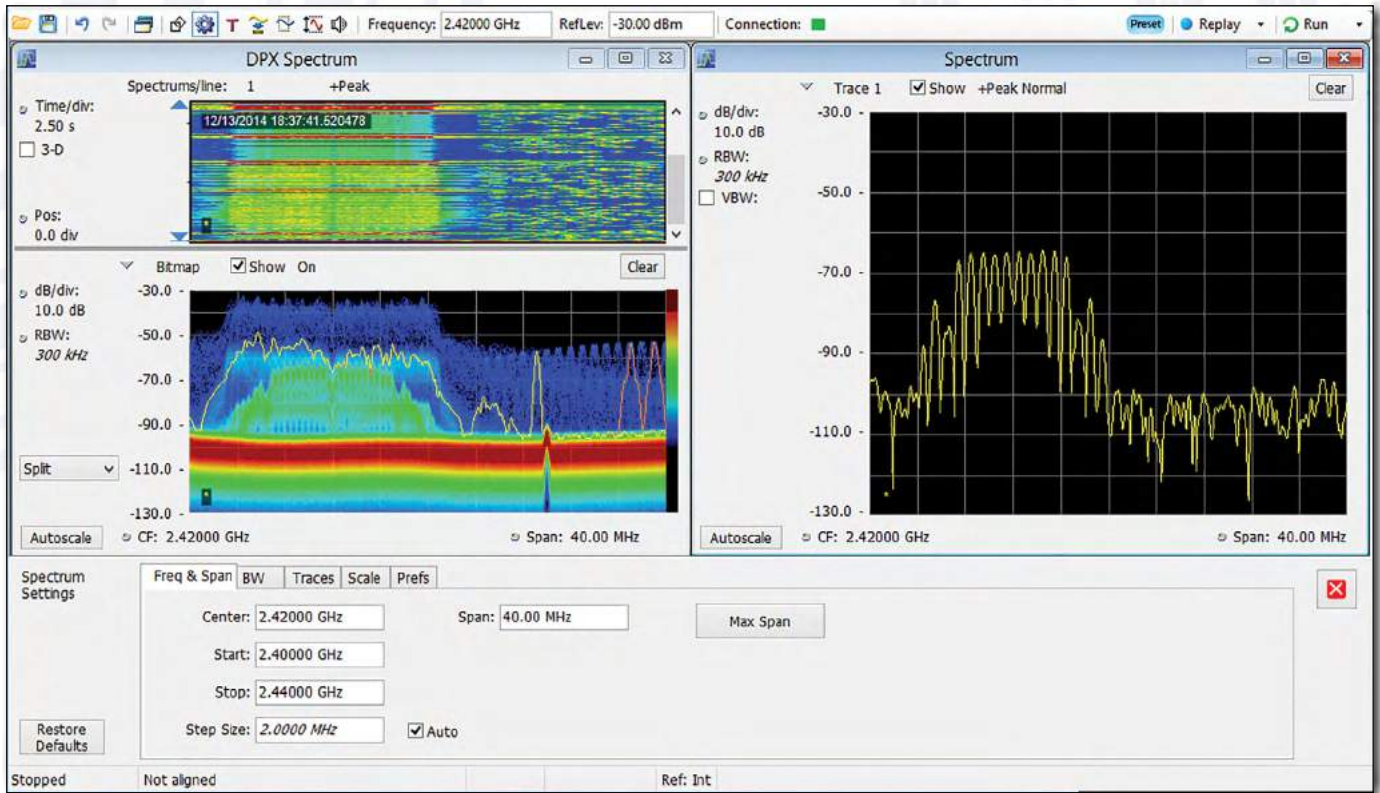

Figure 19 – The user interface screen for the PC-Vu software used by the RSA306 analyzer. This shows a comparison between a swept spectral plot (right) and the real-time plot with spectrogram display (left). We’re looking at a part of the 2.4 GHz ISM band and there are at least three separate Wi-Fi signals, along with a frequency-hopping Bluetooth signal. None of this information is refinement is observable in the swept plot.

The unit is ruggedized with a rubber covering over a cast aluminum enclosure and is about the same size as a paperback novel and costs just \$3,490. The frequency range is 9 kHz to 6.2 GHz and has a dynamic range of +20 to -160 dBm (at minimum resolution bandwidth of 100 Hz). While the FFT architecture is non-overlapping, the unit can capture fast transient pulses with its 40 MHz real-time IF bandwidth, through use of frequency mask triggering. The measurement input is an N connector with protective rubber cap.

One reason for the low cost is that much of the functionality lies in the SignalVu-PC RF analysis software (Figure 19). The software includes 17 standard spectrum and signal analysis measurements, with several optional application-specific options available (\$995, each). These options include mapping, modulation analysis, standards support (such as APCO P25 and WLAN), pulse measurements and frequency settling. The real time (DPX mode) can detect transient or intermittent signals as short as 100 μ s, which would aid in interference hunting (Figure 20). The software can also capture streaming and audio demodulation for long-term surveillance monitoring. Because the personality of the

instrument lies within the software, upgrades and adding optional measurement capabilities are easy.

In summary, the rugged quality of the RSA306 and the functionality Tektronix has built into the SignalVu-PC software is impressive. The RSA306 is a relatively low-cost analysis solution for companies who wish to perform pre-compliance testing or EMI troubleshooting of their products prior to formal compliance testing. I can also see it used in university settings (unit includes a security slot) or training seminars and for applications, such as wireless troubleshooting or hunting down interference to communication systems.

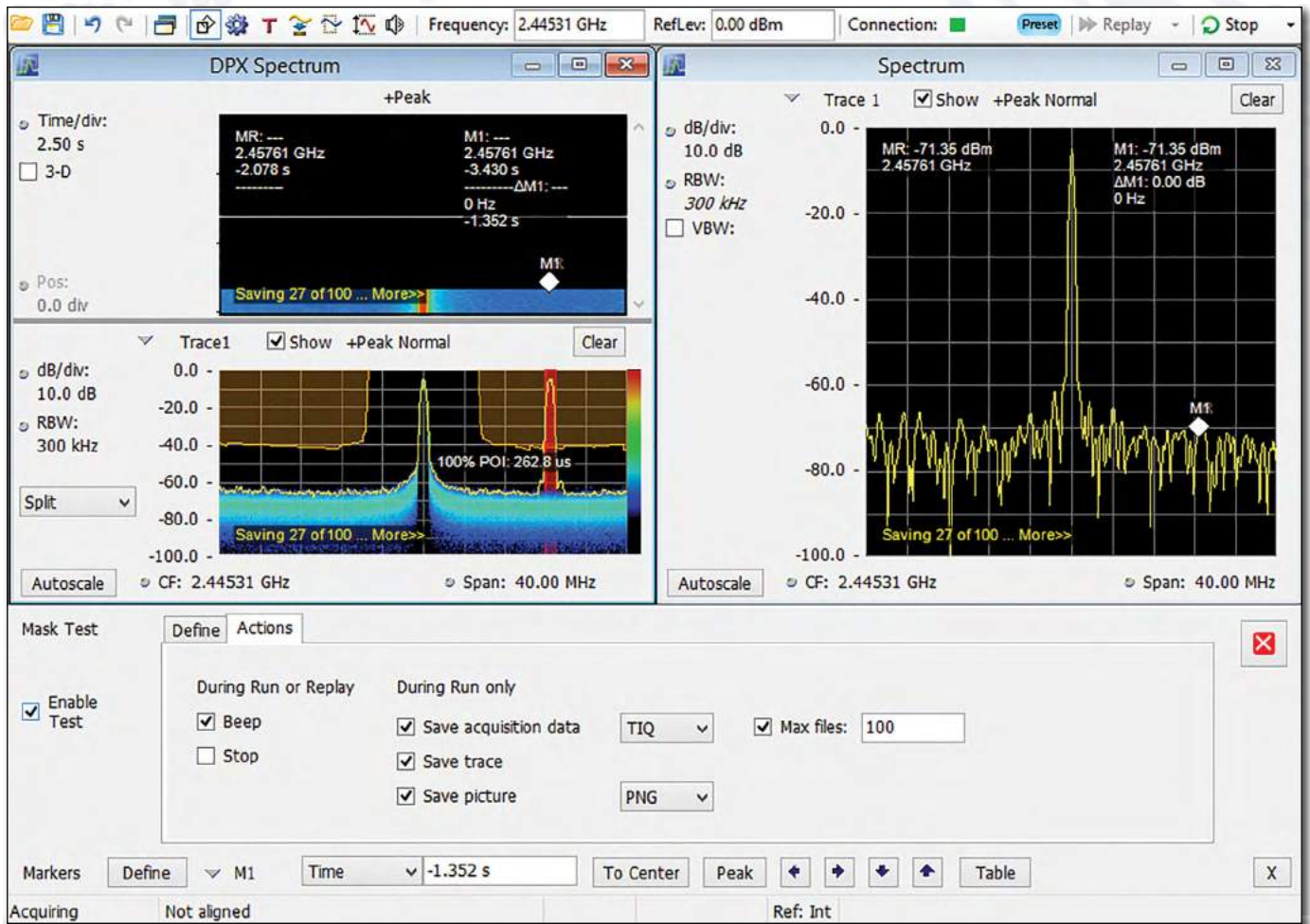

Figure 20 – Another screen capture of the PC-Vu interface showing an intermittent interfering signal in the 2.4 GHz ISM band. Marker “M1” is positioned on the intermittent signal location, but it can’t be seen in the swept plot (right). We’ve configured a frequency mask trigger (lower left), which freezes the interfering signal (shown in red). The spectrogram display (upper left) can then show the timing between interfering pulses.



Figure 21 – The Berkeley Nucleonics RTSA7500 real-time spectrum analyzer tunes 100 kHz to 8/18/27 GHz, depending on the model. The unit is controlled via Ethernet.

I've always thought of **Berkeley Nucleonics Corporation** (BNC) as the “go-to” company for scientific measurement instruments and they're probably not the first company that comes to mind when shopping for general test equipment, such as oscilloscopes and spectrum analyzers. However, BNC recently announced a new line of PC-controlled real-time spectrum analyzers, the RTSA7500-series.

Upon first examination, the unit is well-constructed with little on the front panel except a power switch and SMA RF input port, along with a few status lights. The unit is about 10.5 x 7 x 2.4 inches in size and weighs 6 pounds. The product line includes models with upper frequency ranges of 8, 18, and 27 GHz. All have a lower frequency limit of 100 kHz and a real-time bandwidth of 100 MHz. There's one 8 GHz model (RTSA7500-8B) that just has a 10 MHz real-time bandwidth. All are controlled via an Ethernet port on the rear panel. BNC provides custom PC software to control it. An external 12V 3.3 amp power supply module supplies the analyzer.

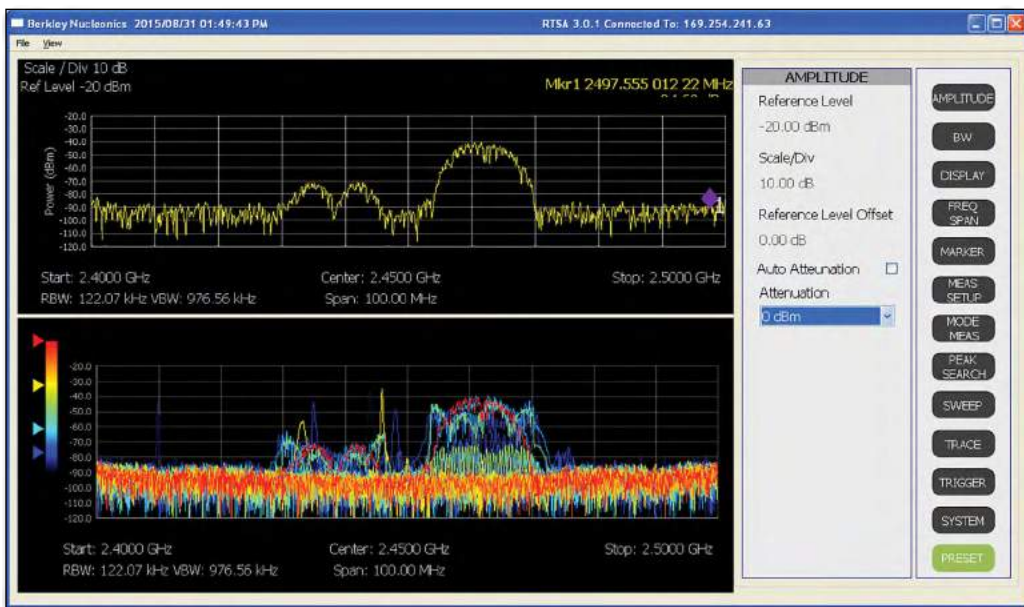

Figure 22 – A screen capture of Wi-Fi and Bluetooth signals using the persistence mode on the Berkeley Nucleonics RTSA7500 analyzer. The software is going through continued development at this early stage, so the final user interface may look different from that shown.

Unlike several competing modular spectrum analyzers, the RTSA7500-8 is controlled via Ethernet. The nice thing about an Ethernet-controlled measuring instrument is the fact the instrument may be placed remotely and controlled and monitored remotely. Good points include the ability to be controlled from Ethernet and the fact the unit is powered from 12 volts allows mobile

or battery operation. I also really like the fact you get a real-time bandwidth of 100 MHz, so, for example, you can observe the entire 2.4 GHz ISM/Wi-Fi band.



Figure 23 – Aaronia sells the same basic Spectran V5 real-time analyzer in a multitude of packages, including this USB-controlled unit. Frequency ranges are 9 kHz to 6/12/16/20 GHz. Real time bandwidths start at 40/80 to 175 MHz, depending on the model and whether you order the increased bandwidth option. Prices range from about \$4,000 to \$10,000 for the USB model. Image courtesy Aaronia AG.

Aaronia AG has been on a development binge lately, introducing their SPECTRAN V5-series in various form factors. Models include the USB-controlled one pictured, as well as one that fits into a standard 5.25-inch PC drive bay, a rack-mount version, an OEM version, and the ruggedized military version shown in the Instrumentation Guide. In addition, they've been actively updating their free PC-based software to include many new features.

The USB-controlled module has an SMA connector for RF input and requires only a single USB cable for power and control, an advantage over some that require two USB cables for power. The analyzer requires just an Intel i5, or equivalent, processor and is only just a bit larger than the Signal Hound BB60C unit.



**SPONSORED
FEATURE:
A PORTABLE
HANDHELD
REAL-TIME
ANALYZER**

Aaronia has recently introduced a unique hand held real-time spectrum analyzer (Figure 24). The model Spectran V5 covers 9 kHz to 6/12/16/20 GHz and offers 40 or 80 MHz real-time bandwidth, upgradable to 80 or 175 MHz, depending on the specific model. It comes with some sophisticated Windows-PC software that displays the usual things like spectrogram and digital I/Q plots.

The unit is controlled via touch screen or conventional buttons and toggle switch. Also available is an optional drop-in desktop charger.

Aaronia also sells several types of reduced-size antennas, as well as a GPS/compass accessory, that when matched with the Spectran V5, would be the ideal setup for mobile or portable interference hunting.



Figure 24 – The Aaronia Spectran V5 in hand held package. Image courtesy Aaronia AG.



REFERENCES

1. Witte, Spectrum and Network Measurements, 2nd Edition, 2014, SciTech Publishing
2. <http://cp.literature.agilent.com/litweb/pdf/5991-4317EN.pdf>
3. https://en.wikipedia.org/wiki/Spectrum_analyzer
4. Wyatt & Gruber, Radio Frequency Interference (RFI) Pocket Guide, 2015, SciTech Publishing
http://www.amazon.com/Radio-Frequency-Interference-Pocket-Electromagnetics/dp/1613532199/ref=asap_bc?ie=UTF8
5. Fundamentals of Real-Time Spectrum Analyzers (Tektronix)
<http://info.tek.com/www-fundamentals-of-real-time-spectrum-analysis.html>
6. The Future of EMC Test Laboratory Capabilities (Rohde & Schwarz)
http://www.rohde-schwarz-usa.com/rs/324-UVH-477/images/Future_of EMC_Test_Laboratory_Capabilities_White_Paper.pdf?allid=7011308
7. Measuring Agile Signals and Dynamic Signal Environments (Keysight)
<https://www.keysight.com/main/editorial.jsp?cc=US&lc=en&ckey=2314444&id=2314444>



2016

EUROPE EMC GUIDE

Now Online